



The Global Language of Business

Guideline Trade Item Information

GDSN Release 3.1.36

GS1 Sweden

Version 1.0, 2026-06-11



Type of information	Value
Document Name	Guideline Trade Item Information, GDSN Release 3.1.36
Document Date	2026-06-11
Document Version	1.0

Document Summary

Version	Date of change	Change made by	Change description
Trade Item Information Guideline GDSN Release 3.1.33 Version 1.0	2025-09-19	L. Nordin	<p>New attributes</p> <p>T4426 Is packaging element intended for food contact T4425 Feed life stage code T4424 Animal target size code</p> <p>Updated definition</p> <p>T3777 Packaging marked label accreditation</p> <p>Updated description</p> <p>T4078 Allergen type code T4079 Level of containment code</p> <p>Updated example</p> <p>T4202 Provenance statement</p> <p>Other updates</p> <p>T4212 Feeding amount T4214 Maximum feeding amount T4215 Minimum feeding amount</p>
Trade Item Information Guideline GDSN Release 3.1.33 Version 1.0	2025-12-10	L.Nordin	<p>Updated Notes</p> <p>T4392 Communication channel code T4393 Communication value</p>
Trade Item Information Guideline GDSN Release 3.1.33 Version 1.0	2025-12-18	L.Nordin	<p>Updated description</p> <p>T3495 Preliminary item status code</p>
Trade Item Information Guideline GDSN Release 3.1.35 Version 1.0	2026-03-18	L. Nordin	<p>New attributes</p> <p>T4427 Does carbon footprint include packaging T4498 Average life T4492 Packaging type description</p> <p>New attributes ECHO data model</p> <p>T4428 Duty fee tax category code T4022 Dangerous goods regulation code T4025 Dangerous goods hazardous code T4429 Additional trade item description T4454 Platform terms and conditions code T4440 Is trade item implantable T4434 UDID device count T4451 Resistance to a surface tension reducing agent indicator T4455 Has device measuring function T4456 Is reusable surgical instrument T4457 Is device exempt from implant obligations T4458 UDI production identifier type code</p>

			<p> T4431 Initial sterilisation prior to use code T4432 Manufacturer declared reusability type code T4453 Maximum cycles reusable T4452 Trade item trade channel code T4435 Does trade item contain human tissue T4436 Clinical size type code T4478 Clinical size value T4437 Clinical size value maximum T4438 Clinical size description T0185 Minimum trade item lifespan from time of arrival T4441 Certification agency T4444 Additional certification organisation identifier T4442 Certification value T4443 Certification effective end date time T4445 Waste code T4446 Required education or training type code T4447 Pre-cleaning indicator T4448 Cleaning disinfection process code T4449 Product cleaning type code T4450 Product disinfection type code T4439 Cumulative temperature interruption acceptable time span instructions T4459 Minimum process temperature timespan T4460 Maximum process temperature timespan </p> <p>New attributes- Byggmaterialhandeln data model</p> <p> T4487 Party address T4442 Certification value T4493 Subject of certification description T4494 Certificate issuance date time T4443 Certification effective end date time T4496 Certification effective start date time T4497 Certification standard T4441 Certification agency T4509 Allowance charge amount T4479 Allowance charge description T4480 Allowance charge percentage T4481 Allowance charge type code T4482 Allowance or charge type T4483 Amount per unit T4464 Registration agency T4465 Registration number T4508 Is base price declaration relevant T4499 Duty fee tax type description T4500 Duty fee tax country code T4501 Duty fee tax amount T4502 Duty fee tax basis T4468 Additional trade item classification version T4469 Additional trade item classification property code T4470 Property float T4471 Property string T4472 Property code T4473 File effective start date time T4474 File effective end date time T4475 Ordering lead time T4476 Order quantity minimum </p>
--	--	--	---

			<p> T4477 Last order date time T4506 Ordering unit of measure T4507 Order quantity multiple T4466 Consumer end availability date time T4461 Card price group identifier T4462 Is substance of very high concern T4463 Is trade item REACH relevant T4488 REACH chemical registration number T4489 SDS sheet effective date time T4490 SDS sheet version T4503 Chemical ingredient scheme T4504 Chemical ingredient identification </p> <p>Deleted attributes</p> <p> T4320 Primary added flavouring code T4321 Secondary added flavouring code </p> <p>Updated descriptions</p> <p> T4066 Diet type code T4358 Claim type code T4077 Allergen statement </p> <p>Updated examples</p> <p> T4360 Descriptive size dimension T3825 Regulation type code T4216 Recommended frequency of feeding </p> <p>Other updates</p> <p> Changed MSB to MCF T4269 Item period safe to use after opening </p>
Trade Item Information Guideline GDSN Release 3.1.35 Version 1.0	2026-04-09	L. Nordin	<p>Updated BMS ID</p> <p> T4415 Cfp country code T4416 Cfp date T4417 Cfp value verification code T4418 Cfp boundaries code T4419 Cfp value T4420 Cfp functional unit T4421 Cfp methodology code T4422 cfp accounting code </p>
Trade Item Information Guideline GDSN Release 3.1.36 Version 1.0	2026-06-11	L. Nordin	<p>New attributes</p> <p> T4486 Additional trade item classification code description T4430 Is trade item a promotional unit T4119 Is trade item a service T4467 Order sizing factor </p> <p>Updated description</p> <p> T0143 Brand name T2230 Subbrand </p> <p>Updated example</p> <p> T4421 Cfp methodology code </p> <p>Updated remark</p> <p> T4230 Catch method code </p>

Table of contents

Introduction	15
Basic concepts	15
Trade item	15
Attribute.....	15
Consumer unit, orderable unit and despatch unit	15
Trade item hierarchy and trade item levels	16
The contents of Trade Item Information	17
Trade Item Document.....	17
Trade item header.....	17
Trade item identities	20
T0154 Trade item, GTIN	20
T0018 Functional name.....	20
T3810 Trade item description	21
T4800 Regulated product name	22
T0143 Brand name.....	23
T2230 Subbrand.....	23
T4344 Variant description.....	23
T3337 Description short.....	24
T4360 Descriptive size dimension	26
T3815 Context identification	27
T3849 Import classification type code.....	27
T3302 Import classification value	28
T4011 Target market country code	28
Reference to trade item.....	29
T3793 Referenced trade item, GTIN.....	29
T3794 Referenced trade item type code.....	30
Additional Identities	30
T3798 Additional trade item identification	30
T3799 Additional trade item identification type code.....	30
Global Model information.....	31
T4352 Global Model Number, GMN.....	31
T4353 Global Model description	31
Trade item unit.....	32
T4010 Trade item unit descriptor code	32
T4012 Is trade item a base unit.....	32
Product classification	33
T0280 GPC category code	33
Additional trade item classification	33
T4238 Additional trade item classification system code.....	34
T4468 Additional trade item classification version	34
T4469 Additional trade item classification property code	34
T4470 Property float	35
T4471 Property string.....	35
T4472 Property code	35

Code for an additional trade item classification	35
T4239 Additional trade item classification code value	35
T4486 Additional trade item classification code description	36
Parties	36
T1115 Manufacturer of trade item, GLN	36
T3811 Manufacturer of trade item, name.....	36
T3750 Brand owner, GLN	37
T3752 Brand owner, name.....	37
Additional parties	37
T3786 Party, GLN	37
T3787 Party, name	38
T4487 Party address.....	38
T3788 Party role code	38
Contact Information	39
T3789 Contact GLN	39
T3790 Contact name	39
T3791 Contact address.....	40
T3792 Contact type code	40
T4406 Target market country code.....	40
Communication channel	41
T4392 Communication channel code	41
T4393 Communication value.....	41
Trade item status	42
T3495 Preliminary item status code	42
T4037 Is trade item a consumer unit.....	42
T0017 Is trade item an orderable unit.....	42
T4038 Is trade item a despatch unit	43
T4014 Is trade item an invoice unit	43
T0186 Is trade item a variable unit.....	43
T4430 Is trade item a promotional unit	44
T4119 Is trade item a service	44
T2227 Consumer first availability date time	44
T3742 First ship date time.....	45
T4120 Is trade item seasonal	45
T4121 Season parameter code.....	45
T4727 Start availability date time.....	45
T4332 Is one time buy	46
Sales conditions	46
T4466 Consumer end availability date time	46
T4131 Consumer sales condition code.....	46
T0147 Price comparison measurement.....	47
T0145 Price comparison content type code	48
T4508 Is Base Price Declaration Relevant	49
T4461 Card price group identifier	49
T2229 Warranty duration.....	49
Distribution details	50
T4475 Ordering lead time	50
Delivery purchasing information	50
T4476 Order quantity minimum	50
T4477 Last order date time	50
T4506 Ordering Unit Of Measure.....	51
T4507 Order Quantity Multiple.....	51
T4467 Order sizing factor	51

T4726 End availability date time	52
T4015 Discontinued date time	52
Product characteristics.....	53
T4144 Are hazardous components removable	53
T4445 Waste code	53
T4265 Product characteristic code	53
T4324 Product characteristic value description	54
T4300 Product characteristic value measurement	54
T4301 Product characteristic value integer	55
T4327 Grade code reference	55
T4328 Grade code reference agency	55
T2522 Is trade item RoHS compliant	55
Carbon footprint header	56
T4415 Cfp country code	56
T4416 Cfp date	56
T4417 Cfp value verification code	57
T4418 Cfp boundaries code	57
T4419 Cfp value	57
T4420 Cfp functional unit	58
T4421 Cfp methodology code	58
T4427 Does carbon footprint include packaging	58
T4422 Cfp accounting code	59
T3778 Chemical ingredient name	59
T3826 Trade item feature code reference	59
T3746 Trade item marketing message	60
T4233 Short trade item marketing message	60
T4204 Trade item key words	60
T4294 Designer	61
T4302 Trade item finish description	61
T4276 Target consumer usage type code	61
T4277 Target consumer minimum usage	62
T4278 Target consumer maximum usage	62
T4331 Target consumer gender	63
T3775 Consumer storage instructions	63
T3776 Consumer usage instructions	63
T4306 Consumer recycling instructions	64
T5036 Non-food ingredient statement	64
T4205 Non-food ingredient name	65
T4206 Is ingredient active	65
Alcohol information.....	65
T2208 Percentage of alcohol by volume	66
T4203 Vintage	66
T4271 Alcoholic beverage sugar content	66
T4315 Bitterness of beer measurement	67
T4333 Bitterness of beer measurement unit code	67
T4316 Alcohol beverage age	67
T4317 Alcohol beverage distilled from code	67
T4318 Alcohol beverage filtering method type code	68
T4319 Alcohol beverage production method type code	68
T4322 Sweetness level of alcoholic beverage code	68
T4323 Origin of wine code	68
Beauty personal care hygiene detail	69
T4345 Formation type code	69
T4346 Time of application code	69
T4347 Skin product function or treatment code	69
T4348 Target skin type code	70

T4349 Hair product function or treatment code	70
T4350 Target hair type code	70
T4351 Natural hair colour code	70
Video display device information	71
T4298 Screen refresh rate.....	71
T4299 Display screen size.....	71
Audio visual media product information.....	71
T4287 Genre type code reference.....	72
Battery type information	72
T3800 Are batteries included	72
T3801 Are batteries required	72
T3802 Are batteries built in.....	73
T4750 Quantity of batteries built in	73
T3803 Battery technology type code	73
T3804 Battery type code	73
T3805 Quantity of batteries required.....	74
T4147 Battery weight.....	74
Lighting device information.....	74
T4291 Light bulb lamp type code	74
T4307 Light bulb base type	75
T4292 Colour temperature.....	75
T4293 Light output.....	75
Colour.....	76
T2241 Colour code list code	76
T2242 Colour code	76
T2243 Colour description	76
Trade item regulatory information	77
T3825 Regulation type code.....	77
T5039 Regulatory act	77
T5040 Regulatory agency.....	78
T4308 Is trade item regulation compliant	78
T4309 Regulatory act compliance level code	79
T5041 Regulatory permit identification.....	79
T5042 Permit start date time	79
Certification Information.....	80
T4497 Certification Standard	80
T4441 Certification agency.....	80
T4433 Additional party identification type code.....	80
T4444 Additional certification organisation identifier	80
Certification.....	81
T4442 Certification value	81
T4493 Subject Of Certification Description	81
T4494 Certificate Issuance Date Time	81
T4496 Certification Effective Start Date Time	82
T4443 Certification effective end date time	82
Safety data sheet information	82
T4489 sDS Sheet effective date time	82
T4490 sDS sheet version	83
GHS details.....	83
T3745 GHS Symbol description code.....	83
T5044 GHS signal words code	84
Chemical ingredient	84

T4503 Chemical Ingredient Scheme	85
T4504 Chemical Ingredient Identification	85
T4488 REACH chemical registration number	85
REACH information	85
T4462 Is substance of very high concern	85
T4463 Is trade item Reach relevant	86
Hazard statement	86
T5047 Hazard statements code	86
T5048 Hazard statements description	87
Precautionary statement	87
T5049 Precautionary statements code	87
T5050 Precautionary statements description	88
Material	88
T4363 Trade item material designation description	88
T4379 Is designation intended for single use	89
T4391 Can materials be separated manually	89
T4380 Number of designation units	89
T4364 Material statement	89
T4365 Material code	90
T4366 Material content	90
T4367 Material percentage	90
T4368 Material thread count	90
T4369 Material weight	91
T4370 Thread denier	91
T4402 Material density	91
T4382 Raw material code	91
T4381 Raw material content percentage	92
Package	92
T0189 Packaging terms and conditions code	92
T0137 Packaging type code	93
T4492 Packaging type description	93
T4124 Packaging function code	93
T4237 Packaging feature code	94
T2244 Platform type code	94
T4454 Platform terms and conditions code	94
T2207 Is trade item a display unit	95
T4372 Packaging sustainability feature code	95
T0277 Is packaging marked returnable	95
Deposit and returnable assets	96
T3828 Returnable asset, GRAI	96
T0148 Returnable package deposit identification	96
T4125 Returnable assets contained quantity	97
Packaging material	97
T1188 Packaging material type code	97
T1189 Packaging material composition quantity	98
T4374 Packaging material classification code reference	98
T4243 Packaging material colour code reference	99
T4354 Packaging material element code	99
T4426 Is packaging element intended for food contact	99
T4355 Packaging material recycling scheme code	100
T4371 Is packaging material recoverable	100
T4283 Packaging labelling coverage percentage	100
T4284 Packaging labelling type code	100
T4383 Number of packaging element units	101

T4384 Packaging material adhesive amount	101
T4385 Packaging material adhesive solubility type code	101
T4386 Packaging material adhesive type code	102
T4405 Packaging material applied process code.....	102
T4403 Multilayer film material composition code	102
T4404 Packaging material density	103
T4412 Additive name	103
T4413 Level of containment code	104
T4285 Packaging raw material code.....	104
T4286 Packaging raw material content percentage	104
Composite material detail	105
T4394 Packaging material type code	105
T4395 Packaging material composition quantity	105
T4396 Packaging material colour code reference	106
T4397 Packaging raw material code.....	106
T4398 Packaging raw material content percentage.....	107
T4387 Packaging claim element code.....	107
T4388 Is packaging claim marked on package	107
T4389 Is packaging claim regulated.....	108
T4390 Packaging claim type code.....	108
Dimensions	108
T4017 Trade item measurements, width	109
T4019 Trade item measurements, height	109
T4018 Trade item measurements, depth	110
T4362 Size type code	110
T4361 Size dimension	111
T4020 Trade item gross weight.....	111
T4330 Trade item net weight.....	112
T0190 Packaging weight.....	112
T4201 Packaging height	112
T3379 Layer height.....	113
Net content.....	113
T0082 Net content	114
T4305 Net content statement	115
Trade item nesting	115
T3378 Nesting increment.....	115
T2236 Nesting direction code	116
Additional dimensions	117
T3816 Dimension type code.....	117
T3817 Additional trade item dimensions, width	118
T3818 Additional trade item dimensions, height	118
T3819 Additional trade item dimensions, depth	119
Storage and handling.....	119
T0167 Minimum trade item lifespan from time of production	119
T0185 Minimum trade item lifespan from time of arrival	120
T2521 Opened trade item lifespan.....	120
T4498 Average life.....	120
T4269 Item period safe to use after opening	121
T4242 Trade item temperature condition type code	122
T3822 Temperature qualifier code.....	122
T3796 Maximum temperature	122
T3797 Minimum temperature	123
T4439 Cumulative temperature interruption acceptable time span instructions	123
T4459 Minimum process temperature timespan	124

T4460 Maximum process temperature timespan	124
T4040 Handling instructions code reference.....	124
T4446 Required education or training type code	125
T3847 Humidity qualifier code	125
T0166 Maximum humidity percentage	126
T0165 Minimum humidity percentage.....	126
T0191 Trade item composition width	126
T4021 Quantity of complete layers contained in a trade item	127
T0160 Quantity of trade items contained in a complete layer	127
T2239 Is trade item packed irregularly	127
T0157 Stacking factor.....	128
T3848 Stacking factor type code	128
Dangerous goods.....	129
T0263 Class of dangerous goods code.....	129
T3743 Dangerous goods classification code.....	129
T4022 Dangerous goods regulation code.....	130
T4025 Dangerous goods hazardous code.....	130
T0264 Dangerous goods packing group	130
T4023 Flash point temperature.....	131
T4303 Net mass of explosives	131
T0169 United Nations dangerous goods number.....	132
T4026 Dangerous goods shipping name	132
T4027 Dangerous goods technical name.....	132
T4247 Dangerous goods limited quantities code	132
T4141 Hazardous material additional information.....	133
T4142 Dangerous goods special provisions.....	133
T3741 ADR tunnel restriction code	133
T3744 Transport category code.....	133
Dangerous goods hazard label.....	135
T4143 Dangerous goods hazard label number	135
T4751 Dangerous hazardous label sequence number.....	135
Cleaning disinfecting information	136
T4447 Pre-cleaning indicator	136
T4448 Cleaning disinfection process code	136
T4449 Product cleaning type code.....	137
T4450 Product disinfection type code	137
Health care item information	137
T4273 Does trade item contain latex	137
T4435 Does trade item contain human tissue	138
T4373 Prescription type code	138
Clinical size	138
T4436 Clinical size type code.....	139
T4478 Clinical size value	139
T4437 Clinical size value maximum.....	140
T4438 Clinical size description	140
Medical device information.....	140
T4455 Has device measuring function	141
T4456 Is reusable surgical instrument	141
T4440 Is trade item implantable	141
T4457 Is device exempt from implant obligations	142
T4274 MRI compatibility code.....	142
T4451 Resistance to a surface tension reducing agent indicator.....	142
T4434 UDID device count.....	143
T4458 UDI production identifier type code.....	143

T4275 Initial manufacturer sterilisation code.....	143
T4431 Initial sterilisation prior to use code.....	143
Healthcare trade item reusability information	144
T4432 Manufacturer declared reusability type code.....	144
T4453 Maximum cycles reusable	144
Origin	145
T0168 Country of origin	145
T4202 Provenance statement.....	146
Product activity details	147
T4375 Country of activity	147
T4235 Product activity type code.....	147
Marks	148
T4400 Packaging marked language code	148
T4357 Claim marked on package	148
T4358 Claim type code.....	148
T4359 Claim element code	149
T4356 Claim description	149
T4032 Trade item date on packaging format type code.....	149
T3362 Trade item date on packaging format name	149
T3777 Packaging marked label accreditation code.....	150
T3850 Compulsory additive label information	151
T4272 Has batch number	151
T4281 Sun protection factor	152
Data carrier.....	152
T3748 Application identifier type code	152
T4310 Data carrier type code	152
T3747 Data carrier presence code.....	153
Trade item external information	153
T2231 Referenced file type code.....	153
T4329 Is primary file	153
T2232 Content description.....	154
T2238 File format name	154
T2233 File name.....	154
T3405 Uniform Resource Identifier	155
T4473 File effective start date time	155
T4474 File effective end date time.....	155
Duty fee taxes.....	155
T4499 Duty Fee Tax Type Description	156
T4033 Duty fee tax agency code	156
T0194 Duty fee tax type code	156
Duty fee tax.....	157
T4500 Duty fee tax country code	157
T4501 Duty Fee Tax Amount	157
T0195 Duty fee tax rate.....	157
T4502 Duty Fee Tax Basis	158
T4428 Duty fee tax category code.....	158
Applicable allowance charge	158
T4481 Allowance charge type code	158
T4479 Allowance charge description	158
T4482 Allowance or charge type.....	159
T4509 Allowance charge amount.....	159
T4480 Allowance charge percentage	159
T4483 Amount per unit	159

Registration information	160
T4464 Registration agency	160
T4465 Registration number.....	160
Packaging hierarchy	160
T4034 Quantity of children	160
T4035 Total quantity of next lower level trade item	161
Trade item hierarchy	161
T2045 Child trade item, GTIN	161
T3361 Quantity of next lower level trade item	162
Trade item components	162
T3832 Total quantity of components	162
T3833 Number of unique components	163
T3838 Multiple container quantity.....	163
Component	163
T3834 Component number	164
T3836 Component identification.....	164
T3837 Component quantity	164
T3835 Component description.....	165
T3839 Component multiple packed quantity	165
T3815 Context identification (Linked from component)	165
T0280 GPC category code (Linked from component)	165
Extensions - Attributes or modules that can be applied on component level	165
Serving information	166
T4092 Number of servings per package	166
T4036 Number of smallest units per package	166
T4093 Maximum number of smallest units per package.....	167
Ingredient information	167
T4088 Ingredient statement	168
Nutritional information	169
T4069 Preparation state code	169
T4070 Daily value intake reference	170
T3820 Nutrient basis quantity type code	170
T3824 Nutrient basis quantity.....	170
T4399 Nutrient basis quantity description.....	171
Nutrient facts	171
T4076 Daily value intake percent	171
T4073 Nutrient type code	172
T4075 Measurement precision code.....	172
T4074 Quantity contained.....	172
T4407 Nutrient name on package.....	173
Allergen information	173
T4077 Allergen statement.....	174
Allergen	174
T4078 Allergen type code	174
T4079 Level of containment code	175
Diet type	175
T4066 Diet type code	175
T4279 Diet type subcode	176
T4312 Is diet type marked on package	176
Preparation information	176
T4138 Manufacturer preparation type code.....	176

Preparation information for the user	177
T4082 Preparation type code	177
T4083 Preparation instructions	177
T4091 Serving suggestion	177
T4136 Maximum optimum consumption temperature	178
T4137 Minimum optimum consumption temperature	178
Organism classification	179
T4325 Genus	179
T4326 Species	179
Fish reporting information	179
T4228 Species for fishery statistics purposes code	179
T4229 Species for fishery statistics purposes name	180
T4401 Fish seafood presentation code	180
Fish catch information	181
T4230 Catch method code	181
T4280 Catch area code	181
T4231 Production method for fish and seafood code	182
T4232 Storage state code	182
Farming and processing information	182
T4246 Preservation technique code	182
Organic certification	183
T4378 Organic certification identification	183
Organic claim	183
T4377 Organic trade item code	183
Trade item organic information	183
T4376 Organic product place of farming code	183
Animal feeding information	184
T4222 Targeted consumption by	184
T4223 Feed type code	184
T4250 Feed additive statement	185
T4249 Feed analytical constituents statement	185
T4248 Feed composition statement	186
T4251 Feeding instructions	186
T4410 Animal food type code	186
T4409 Animal targeted health condition code	187
T4425 Feed life stage code	187
T4424 Animal target size code	187
Animal feeding	188
T4208 Feed life stage	188
T4209 Maximum weight of animal being fed	188
T4210 Minimum weight of animal being fed	189
Animal feeding detail	189
T4212 Feeding amount	189
T4214 Maximum feeding amount	189
T4215 Minimum feeding amount	190
T4216 Recommended frequency of feeding	190
How to fill in Trade item information	191
Shelf-edge labels	191
Comparative price	192
Trade Item Information for bake-off bread to be baked in-store	192
Trade Item Information for items of varying weight	192

Measurement guide for selected code values in T4362 Size type code	193
Trade Item Information for books and audiobooks.....	194
Trade item levels in a trade item hierarchy	195
Example 1. A pallet of boxes containing bottles of shampoo	195
Example 2. A pallet of boxes containing 6-packs of mineral water	196
Example 3. Loose items – A pallet with boxes of apples	196
Example 6. A brewery pallet	198
Describing a trade item hierarchy in Trade Item Information	199
Example 1. An outer case with three different types of sausage.....	199
Example 2. A box containing 6 bottles of glue.....	200
Consumer unit, orderable unit and/or despatch unit.....	201
Example 1. A pallet of boxes of bottles of shampoo	201
Example 2. A pallet of boxes containing 6-packs of mineral water	202
Example 3. A display pallet of cat food.....	202
Example 4. A pallet of buckets of tzatziki	203
Seasonal goods	203
Package type and deposit for Svenska Retursystem pallets.....	203
Trade Item Information to comply with CLP regulation.....	204
Trade Item Information to comply with MCF guidelines on dangerous goods	206
Example	207
* T4751 Dangerous hazardous label sequence number: Usage	207
** T4247 Dangerous goods limited quantities code: Usage	207
Application Instructions for Components.....	208
T4088 Ingredient statement and T3850 Compulsory additive label information	210
Examples of texts specified in T4088 Ingredient statement	210
Examples of texts specified in T3850 Compulsory additive label information	211
Other examples of texts specified in T3850	211
Examples of texts specified in other attributes.....	212
Information for system developers and recipients of Trade Item Information	213
Structure of Trade Item Information as described in this guideline.....	214

Introduction

This guideline is a description of the Swedish implementation of GS1 Trade Item Information. It is intended for suppliers who send Trade Item Information to their recipients and aims to provide the knowledge needed to supply correct Trade Item Information. Parts of the document are intended for system developers and recipients of Trade Item Information. Read more in the chapter [Information for system developers and recipients of Trade Item Information](#).

This document should be used as a reference guide for Trade Item Information. Search for information using:

- **The search box** – Use the shortcut [ctrl]+f to access the search box.
- **The bookmarks panel in the navigation panel**

The document is best viewed on a computer connected to the internet since it contains links to information stored elsewhere.

Basic concepts

Trade item

A trade item is a product or service that may be priced, ordered or invoiced at any point in the supply chain. Examples of trade items are: a bottle of shampoo, a box containing six bottles of shampoo, a pallet of boxes containing bottles of shampoo.

Attribute

Trade Item Information is described using **attributes**. Each attribute describes a certain part of Trade Item Information, such as the height of the trade item, the width of the trade item, or its brand name. An attribute is comprised of an attribute name, an attribute number and a definition. **Example:** The attribute describing the trade item height is comprised of the following attribute number, attribute name and definition:

- **Attribute number:** T4019
- **BMS ID:** 3725
- **Attribute name:** Trade item measurements, height
- **Definition:** The height of the trade item, as measured according to the GS1 Package and Product Measurement Standard. If the trade item is a unit load, include the shipping platform unless it is excluded according to the platformTypeCode chosen.

The attribute number is unique to the attribute and makes it easy to keep track of the attribute even if it should change its name.

The BMS ID (GS1 Business Message Identifier) is a globally unique attribute number.

Additional information is often linked to the attribute, such as a detailed description and examples showing how the attribute should be used.

All Trade Item Information attributes are described in section [The contents of Trade Item Information](#) below.

Consumer unit, orderable unit and despatch unit

A trade item can have several attributes related to how it is intended to be sold and distributed at different stages of the supply chain. Every trade item can have attributes indicating that it is a consumer unit, an orderable unit, or a despatch unit.

- **Consumer unit:** The trade item is intended to be sold to a consumer or end user at point of sale.
- **Orderable unit:** The trade item is ordered from the supplier by a wholesaler, store, or similar.
- **Despatch unit:** The trade item, usually a pallet, that is physically delivered from the supplier to the customer.

A detailed description and examples can be found in the section [Consumer unit, orderable unit and/or despatch unit](#).

Trade item hierarchy and trade item levels

A trade item hierarchy shows which consumer units a case contains, or which cases a pallet contains. The buyer needs information about the trade items at each level of the trade item hierarchy, so Trade Item Information must specify this information at each level.

There are three possible levels in a trade item hierarchy:

- **Base level:** The lowest level of a trade item hierarchy. A trade item at base level contains no items identified with a GTIN. Examples: A bottle of mineral water, or a bucket for the food service industry.
- **Case level:** The middle level of a trade item hierarchy. A trade item at case level contains other trade items and is also itself contained in a trade item. Example: A box with six bottles of shampoo.
- **Pallet level:** The highest level of a trade item hierarchy. A trade item at pallet level contains other items but is not itself contained in another trade item. Example: A pallet of boxes containing bottles of shampoo.

Each item at the different levels is given a GTIN. Trade Item Information is sent for every GTIN, since they have different attributes, such as different dimensions. Using the item levels, it is easy to describe an item hierarchy.

A detailed description and examples can be found in the section [Trade item levels in a trade item hierarchy](#).

The contents of Trade Item Information

This section describes the attributes used in Trade Item Information (see section [Attribute](#) for the definition of an attribute). Attributes are arranged in groups according to their usage area. Each group features an introductory description of the usage area. A figure showing the structure of the groups of attributes can be found in section [The structure of Trade Item Information as described in this guideline](#).

Trade Item Document

This group is used to specify Trade Item Information for a complete trade item hierarchy.

T0153 Document command

BMS ID	23
Definition	Code indicating if the information is an addition, a change, or a correction
Description	<p>Code indicating if the information is for a new item, changed item or corrected Trade Item Information. Note that the document command applies to the whole trade item hierarchy.</p> <p>New: Used when one or more items in the trade item hierarchy are new and are being declared for the first time. Also used when the pallet level item is new and the case and base level items are unchanged.</p> <p>Change: Used when one or more items in the hierarchy is changed. Depending on the type of change, the product GTIN may either be kept or a new GTIN may be needed. See GS1's GTIN rules at http://www.gs1.org/gtinrules.</p> <p>Correction: Used when the Trade Item Information for one or more items has been corrected. Correction means that previously missing information has been supplied, or that previously submitted information was incorrect and is now corrected, without the item itself having changed (for example, correction of a spelling mistake in the item name).</p> <p>Always choose a code in relation to previously sent information on the item that has been approved by Validoo. For example, if an attempt to register a new item is rejected by Validoo, the Trade Item Information should be corrected and resubmitted. In this case, the item is still a new item.</p>
Code value	Code value is specified according to code list T0153, see www.gs1.se/en-codelist-T0153 .

T0151 Creation date time

BMS ID	29
Definition	Date and point of time when the business document was created.
Description	<p>The date and point of time when the information provider of trade item created the Trade Item Information.</p> <p>Times are expressed in UTC (Coordinated Universal Time), with a UTC designator ("Z").</p>
Example	2020-02-18T21:51:31Z

Trade item header

This group is used to specify general information about the trade item.

Level	Component	Base	Case	Pallet
M = mandatory C = conditional - = not used	-	M	M	M

T1124 Information provider of trade item, GLN

BMS ID	83			
Definition	Identity, according to GS1's identification system, of the party who has created the business document.			
Description	<p>The identity is a globally unique and unambiguous number.</p> <p>The information provider of trade item is the party who creates, changes, maintains and is responsible for the Trade Item Information. The Trade Item Information shouldn't therefore be changed by other parties.</p>			
Level	Component	Base	Case	Pallet
M = mandatory C = conditional - = not used	-	M	M	M

T3807 Information provider of trade item, name

BMS ID	85			
Definition	Name of the party who has created the business document.			
Description	The information provider is the party who creates, changes, maintains and is responsible for the Trade Item Information. The Trade Item Information shouldn't therefore be changed by other parties.			
Level	Component	Base	Case	Pallet
M = mandatory C = conditional - = not used	-	M	M	M

T3809 Data recipient

BMS ID	40			
Definition	Identity, according to GS1's identification system, of the party that is authorized to view, use, download a set of Master Data provided by a Data Source.			
Description	The identity is a globally unique and unambiguous number.			
Level	Component	Base	Case	Pallet
M = mandatory C = conditional - = not used	-	M	M	M

T4452 Trade item trade channel code

BMS ID	65			
Definition	A grouping of entities by common business model concentration used to define the distribution or marketing segmentation of products, customers and geographic areas into common groups that are supplied, serviced and measured in similar ways.			
Code value	Code value is specified according to code list: T4452 Trade item trade channel code			
OBS!	This attribute is part of the ECHO data model; for further guidance and detailed information, see: Common ECHO data model .			
Level	Component	Base	Case	Pallet
M = Mandatory C = Conditional - = not used	-	C	C	-

T3806 Effective date time

BMS ID	144			
Definition	Date and point of time from which the information in this business document is effective.			
Description	<p>The date on which the Trade Item Information for this item is effective. This effective date can be used for initial trade item offering, or to mark a change in the information related to an existing trade item. This date would specify when these changes take effect.</p> <p>Times are expressed in UTC (Coordinated Universal Time), with a UTC designator ("Z").</p>			
Example	2017-12-17T15:45:00Z			
Level	Component	Base	Case	Pallet
M = mandatory C = conditional - = not used	-	M	M	M

T4008 Last change date time

BMS ID	145			
Definition	Date and point of time on which the Trade Item Information last was changed in the information provider's system.			
Description	<p>When the attribute is used it allows the data pool to control the trade item data version. The date and time is not allowed to be a date and time in the future.</p> <p>Note that the last change date time can be different date and point of times for different items in a trade item hierarchy.</p> <p>Times are expressed in UTC (Coordinated Universal Time), with a UTC designator ("Z").</p>			
Example	2017-12-17T15:45:00Z			
Level	Component	Base	Case	Pallet

M = mandatory C = conditional - = not used	-	M	M	M
---	---	---	---	---

Trade item identities

This group is used to specify information that identifies the trade item. This includes GTIN, item name, brand, shelf-edge and till-roll texts, and the hierarchical level of the trade item.

Level	Component	Base	Case	Pallet
M = mandatory C = conditional - = not used	-	M	M	M

T0154 Trade item, GTIN

BMS ID	67			
Definition	Identity of the trade item according to GS1's identification system.			
Description	<p>GTIN is a globally unique and unambiguous number. Every trade item must have a unique GTIN for ordering and statistical purposes.</p> <p>GS1 has a set of rules governing which changes on a trade item that require a new GTIN and which are permitted without the GTIN being changed. Read more about GS1's GTIN rules at www.gs1.org/gtinrules.</p>			
Level	Component	Base	Case	Pallet
M = mandatory C = conditional - = not used	-	M	M	M

T0018 Functional name

BMS ID	3508
Definition	Name of the category to which the trade item belongs.
Description	<p>Functional name must be used to clarify which product category the article belongs to. It must not contain information about, for example, T0143 Brand name, T4360 Descriptive size dimension, T4344 Variant description or T0082 Net content.</p> <p>Details should be at a fairly high level and stay within established industry categorizations whenever possible. The information provider is responsible for ensuring that the functional name is the same value across all levels in a hierarchy. It must be the same on similar items regardless of brand and product name, e.g. Eggs, Shampoo, Diapers, Chef Coat, Frying Pan.</p> <p>Exceptions are displays or gift packaging containing products with different functional names (a homogeneous display/gift packaging is specified as above, i.e. the same functional name across all levels in a hierarchy). The exception refers to the level that is the display and the overlying level, if any. In that case, these must have the same value.</p> <p>The functional name can be used for receipt text.</p> <p>If the accepted functional name contains more than one word, the main category must be entered first, for example "milk flavored".</p> <p>Enter the information using the Swedish character set.</p>

Example	<p>Product 1: GS1 Brand Fresh Mango & Orange smoothie Eko 150ml Example of approved functional name: "Smoothie" Example of not approved functional name: "Smoothie 150ml Eko"</p> <p>Product 2: GS1 Brand Natural Hair Color Liquid Light to Medium Blonde 1 st" Example of approved functional name: "Hair Color" Example of not approved functional name: "Hair Color Medium Blonde"</p>			
Note	Allows for the representation of the same value in different languages, but not for multiple values.			
Level	Component	Base	Case	Pallet
M = mandatory C = conditional - = not used	-	M	M	M

T3810 Trade item description

BMS ID	3517			
Definition	An understandable and useable description of a trade item.			
Description	<p>Trade item description that can be understood by consumers and be used as a searchable product name. One recommendation is to use brand name, sub brand, functional name, variant, net content and, where applicable on case level, quantity of next lower level trade item. Variation of writing rules may apply depending on sector and product group.</p> <p>The attribute can be used by retailers to understand brand, taste, fragrance, etc. of a specific GTIN, and as a tool to create an appropriate product description in internal systems.</p> <p>Use as few abbreviations as possible. Always specify the information in Swedish.</p>			
Example	<p>Base: Flingans Fresh Frukostflingor Jordgubb 500 g</p> <p>Case: Vitatänder Exklusiv Tandkräm Mint 75 ml x 4</p>			
Note	Allows for the representation of the same value in different languages, but not for multiple values.			
Level	Component	Base	Case	Pallet
M = mandatory C = conditional - = not used	-	C	C	C

T4429 Additional trade item description

BMS ID	3504			
Definition	Additional variants necessary to communicate to the industry to help define the product. Multiple variants can be established for each GTIN. This is a repeatable field, e.g. Style, Colour, and Fragrance.			
OBS!	This attribute is part of the ECHO data model; for further guidance and detailed information, see: Common ECHO data model.			
Level	Component	Base	Case	Pallet
M = Mandatory C = Conditional - = not used	-	C	C	C

T4800 Regulated product name

BMS ID	3515			
Definition	The prescribed, regulated or generic product name or denomination that describes the true nature of the food and is sufficiently precise to distinguish it from other foods according to country specific regulation.			
Description	<p>The regulated product name describes the nature of the product and is precise enough to distinguish it from other foods according to the regulations of a particular country.</p> <p>The attribute is also used to indicate the trade name of the fish or aquaculture product, see the Swedish Food Agency instructions.</p> <p>Always specify the information in Swedish.</p>			
Note	Allows for the representation of the same value in different languages, but not for multiple values.			
Level	Component	Base	Case	Pallet
M = mandatory C = conditional - = not used	-	C	C	C

T0143 Brand name

BMS ID	3541			
Definition	Supplier's brand name for this item.			
Description	<p>The Brand name is used for internal use and on shelf-edge labels as information for customers.</p> <p>The supplier determines the brand and ensures that it is written in the same way for all items. In some exceptional cases, the product name is the same as the brand.</p> <p>If the trade item consists of several different trade items with different brand names, one of these should be chosen.</p> <p>Brand name is not permitted to be changed without assigning the trade item a new GTIN (Global Trade Item Number). Read more about GS1's GTIN rules at www.gs1.org/gtinrules.</p>			
Level	Component	Base	Case	Pallet
M = mandatory C = conditional - = not used	-	M	M	M

T2230 Subbrand

BMS ID	3546			
Definition	Second level of brand.			
Description	<p>The attribute is used when there are several levels of the brand.</p> <p>The supplier determines the brand and ensures that it is written in the same way for all items. A sub-brand can be a product series or model.</p>			
Example	<p>Product 1: GS1 Brand Natural Hair Color Liquid Light to Medium Blonde 1 st" Example of approved subbrand: "Natural" Example of not approved subbrand: "Hair color"</p> <p>Product 2: GS1 Brand Fresh Mango & Orange smoothie Eko 150ml Example of approved subbrand: "Fresh" Example of not approved subbrand: "Smoothie Eko"</p>			
Level	Component	Base	Case	Pallet
M = mandatory C = conditional - = not used	-	C	C	C

T4344 Variant description

BMS ID	3520
Definition	Free text field used to identify the variant of the product.

<p>Description</p>	<p>Variant description is a supplementary attribute to T3337 Description short. Variant are distinguishing features that distinguish products with the same T0143 Brand name and T3337 Description short and T4360 Descriptive size dimension. Variant can, for example, be the flavor of a yoghurt, the scent of a soap or the color of a sweater. The variant may appear in the product name.</p> <p>The attribute can be used to indicate supplementary information for the product and is used when there is no separate attribute for the variant. For example, there are separate attributes for the information free from, gluten-free, lactose, sun protection factor:</p> <p>T4358 Claim type code T4359 Claim element code T4281 Sun protection factor</p> <p>In cases where you specify colour as a variant, T2243 Colour description must also be filled in within the Beauty sector.</p> <p>The following writing rules apply to Variant description:</p> <ul style="list-style-type: none"> ▪ The following characters should never be used to end words in abbreviations: <ul style="list-style-type: none"> ○ Comma (,) ○ Period (.) ○ Semicolon (;) ▪ The character / is entered as a separator between similar properties, e.g. colours and flavors. Ex: White/Green, Strawberry/Wild strawberry <p>Descriptive size dimension is entered in T4360 Descriptive size dimension.</p>			
<p>Example</p>	<p>Product 1: GS1 Brand Fresh Mango & Orange smoothie Eko 150ml Example of approved variant description: "Mango/orange" Example of not approved variant description: "Mango/orange 150ml"</p> <p>Product 2: GS1 Brand Fabric softener Lavender 1,8 L refill Example of approved variant description: "Lavender" Example of not approved variant description: "Lavender 1,8 L, refill"</p> <p>Product 3: GS1 Brand Socks woolmix black/white 39-42 Example of approved variant description: "Black/White" and "39-42" Example of not approved variant description: "Socks"</p>			
<p>Level</p> <p>M = mandatory C = conditional - = not used</p>	<p>Component</p> <p>-</p>	<p>Base</p> <p>C</p>	<p>Case</p> <p>C</p>	<p>Pallet</p> <p>C</p>

T3337 Description short

<p>BMS ID</p>	<p>3506</p>
----------------------	-------------

Definition	Name of the trade item, used for identification.
Description	<p>Description short can be printed on shelf edge labels and receipt text and used in e-commerce as information for consumers.</p> <p>The description short must primarily be the same text as the packaging is marked with. The attribute is limited to 40 characters. If the text on the packaging contains more than 40 characters, the text must be abbreviated. The words should be shortened so that the text still matches the text on the packaging and so that the text cannot be misunderstood.</p> <p>The information provider is responsible for ensuring that the description short is the same across all levels in a hierarchy. Exceptions are made on displays that are homogeneous or mixed and refer to the level that is the display and the overlying level if there is one. In that case, these must have the same value. The recommendation is that the product name on display is built up using T0018 Functional name and the word "Display" or "Display Mix" at the beginning. Information about multipacks can be entered according to the writing rules below.</p> <p>In some exceptional cases, the description short is the same as the brand. T4360 Descriptive size dimension is not part of the description short. In some industry categories, information about variants such as taste, size (for example 250 ml, 15 cl, 28 Ø and S, M, L), fat content, alcohol content can be relevant information in the description short.</p> <ul style="list-style-type: none"> ■ The following print rules apply to Description short: The following characters must not be used at the end of abbreviated words <ul style="list-style-type: none"> • Comma (,) • Period (.) • Semicolon (;) ■ Period (.) shall be used as a separator in numeric expressions, e.g. 2.8% ■ For alcohol products, alcohol percentage must be included in "Description short" ■ A slash (/) shall be used as a separator between similar properties such as colour or flavour, e.g. WHITE/GREEN, STRAWBERRY/WILD STRAWBERRY ■ For multipacks the number in the pack should be followed by the letter "P" alternatively "pack" E.g. 4P or 4-pack ■ The number of servings provided by a product should be shown followed by PORT, e.g. 12 PORT

Example	<p>Product 1: GS1 Brand Fresh Mango & Orange smoothie Eko 150ml Example of approved description short: Smoothie Eko</p> <p>Product 2: GS1 Brand Natural Hair Color Liquid Light to Medium Blonde 1 st" Example of approved description short: Hair Color Liquid</p> <p>Product 3 (Display mix of products): GS1 Brand Fresh Mango & Orange smoothie Eko 150ml + GS1 Brand Fresh Raspberry smoothie Eko 150ml Example of approved description short: Display Mix Smoothie Eko</p>			
Note	Allows for the representation of the same value in different languages, but not for multiple values.			
Level	Component	Base	Case	Pallet
M = mandatory C = conditional - = not used	-	M	M	M

T4360 Descriptive size dimension

BMS ID	7218
Definition	Text indicating article size.
Description	<p>The attribute is used for specifying a size intended for identifying the item, e.g. 500G, 1200W, 1.5L, 7pcs. The information is used internally and on shelf-edge labels and to receipts as information for consumers. The information is usually on the front of the package.</p> <p>This attribute is mandatory if the trade item is a consumer unit with a barcode, and if it is intended for retail sale. Certain types of items, for example small cosmetic trade items, are excluded from the rule.</p> <p>Always specify the information in Swedish.</p> <p>See print rules for "T3337 Description short".</p> <p>The value is limited to 8 characters according to Swedish application.</p> <p>If both the net content and the number of pieces are written on the front of the package, it is recommended to enter the number of pieces in "T4360 Descriptive size dimension" and net content in "T0082 Net content". The attribute "T4305 Net content statement" is also an option to describe size/quantity in the package.</p>
Example	<p>Example 1: Cookies - front of package labeled 7 pcs, 170g. "T4360 Descriptive size dimension": 7 pcs "T0082 Net content": 170g</p> <p>Example 2: Multipack soft drink – front of package labeled 10x330ml "T4360 Descriptive size dimension": 10x330ml "T0082 Net content": 3.3L</p> <p>Example 3: Chicken fillets - front of package labeled 4 pcs, approx. 150g/pcs, 600g. "T4360 Descriptive size dimension": 4 pcs "T0082 Net content": 600g "T4305 Net content statement": approx. 150g/fillet</p> <p>Example 4: Paper color – front of the package marked approx. 1000 g</p>

	<ul style="list-style-type: none"> • T4360 Descriptive size dimension. 1000 g • T0082 Net content: 1000 g <p>Example 5: For food preserved in liquid, total weight should be specified in "T4360 Descriptive size dimension".</p> <p>To specify weight excluding liquid, so-called drained weight, use the following attributes together:</p> <p>"T0145 Price comparison content type code": DRAINED_WEIGHT – By drained weight</p> <p>"T0147 Price comparison measurement"</p>			
Note	Allows for the representation of the same value in different languages, but not for multiple values.			
Level	Component	Base	Case	Pallet
M = mandatory C = conditional - = not used	-	C	C	-

T3815 Context identification

BMS ID	55 (323?)			
Definition	The unique identifier established for the context managed by GS1.			
Description	For a single trade item, different sets of modules may be required depending on how the trade item is used. The attribute controls the validation depending on the product group specified.			
Code value	Code value is specified according to code list T3815, see www.gs1.se/en-codelist-T3815 .			
Level	Component	Base	Case	Pallet
M = mandatory C = conditional - = not used	C	C	C	C

T3849 Import classification type code

BMS ID	2776
Definition	Imports and exports of trade items typically require classification codes to determine appropriate duties and tariffs.
Description	<p>Classification codes have several different uses, for example:</p> <ul style="list-style-type: none"> • when importing and exporting trade items to determine which customs duties and tariffs should be applied. • as statistical commodity code for intrastat reporting. • to identify whether the product is subject to legislation. <p>This attribute should be used together with "T3302 Import classification value".</p>
Example	<p>The specified code in "T3849 Import classification type code" affects the number of digits that must be entered in "T3302 Import classification value".</p> <p>Example 1: "T3849 Import classification type code": INTRASTAT – INTRASTAT "T3302 Import classification value": 09012100</p> <p>Example 2:</p>

	"T3849 Import classification type code": _TARIF_INTEGRE_DE_LA_COMMUNAUTE – Integrerad tariff för Europeiska unionen (TARIC) "T3302 Import classification value": 0901210000			
Code Value	Code value is specified according to code list T3849, see www.gs1.se/en-codelist-T3849 .			
Level	Component	Base	Case	Pallet
M = mandatory C = conditional - = not used	-	C	C	-

T3302 Import classification value

BMS ID	2777			
Definition	Customs product code.			
Description	The code is specified according to the type of classification stated in "T3849 Import classification type code". This attribute should be used together with "T3849 Import classification type code".			
Example	The specified code in "T3849 Import classification type code" affects the number of digits that must be entered in "T3302 Import classification value". Example 1: "T3849 Import classification type code": INTRASTAT – INTRASTAT "T3302 Import classification value": 09012100 Example 2: "T3849 Import classification type code": _TARIF_INTEGRE_DE_LA_COMMUNAUTE – Integrerad tariff för Europeiska unionen (TARIC) "T3302 Import classification value": 0901210000			
Code Value	Choose code values from external code list, see www.tullverket.se .			
Level	Component	Base	Case	Pallet
M = mandatory C = conditional - = not used	-	C	C	-

T4011 Target market country code

BMS ID	112
Definition	Code indicating the country level or higher geographical definition in which the information provider will make the trade item available to buyers.

Description	<p>The target market country does not in any way govern where the buyer may resell the trade item to consumers.</p> <p>The attribute must be used once per item. If the item is intended for more than one target market item information must be sent once per target market.</p>			
Code value	<p>Code value is specified according to code list T3783, see www.gs1.se/en-codelist-T3783.</p> <p>Code is specified according to ISO 3166-1 (three digit numeric).</p>			
Level	Component	Base	Case	Pallet
M = mandatory C = conditional - = not used	-	M	M	M

Reference to trade item

This group refers to trade item, not in the trade item hierarchy, that is referenced for a specific purpose for example substitute, replaced, equivalent trade items.

Level	Component	Base	Case	Pallet
M = mandatory C = conditional - = not used	-	C	C	-

T3793 Referenced trade item, GTIN

BMS ID	116			
Definition	The identification of the referenced trade item, GTIN.			
Description	<p>The identity is a globally unique and unambiguous number.</p> <p>The attribute is used to identify a trade item that is related to this trade item in one way or another. The reference is specified by stating the type of relationship in question and the GTIN in question.</p> <p>The attribute can also be used to indicate that this trade item has replaced another trade item. Specify the discontinued GTIN that has replaced this trade item.</p> <p>It can also be used when the trade item is a variant of a previously specified trade item in the buyer's line. Example: A new flavor of an existing soft drink.</p> <p>The attribute may be used when the trade item has identical package type, physical dimensions and brand name as the item variant master trade item. This attribute only creates a logical link to a similar product. All Trade Item Information for the item must still be sent.</p> <p>Another name for the new item, which is a variant of the item variant master, is "line extension".</p> <p>Enter the current GTIN and then select the type of article that is referred to by selecting the type in the code list T3794.</p>			
Level	Component	Base	Case	Pallet
M = mandatory C = conditional - = not used	-	M	M	-

T3794 Referenced trade item type code

BMS ID	115			
Definition	A code depicting the type of trade item that is referenced for a specific purpose.			
Description	The code describes the relationship trade items have to each other. Referenced trade item type code can, for example, be replaced and item variant master.			
Code value	Code value is specified according to code list T3794, see www.gs1.se/en-codelist-T3794 .			
Level	Component	Base	Case	Pallet
M = mandatory C = conditional - = not used	-	M	M	-

Additional Identities

This group refers to other alternatives to the Global Trade Item Number to identify a trade item.

Level	Component	Base	Case	Pallet
M = mandatory C = conditional - = not used	-	C	C	C

T3798 Additional trade item identification

BMS ID	68			
Definition	An identification depicting the type of trade item that is referenced for a specific purpose.			
Description	This attribute must always be used together with "T3799 Additional trade item identification type code", meaning that if T3799 is used then T3798 must also be used. In Swedish implementation, an additional trade item identification cannot exceed 14 characters.			
Note	Note that the information in the attribute may vary depending on the recipient.			
Level	Component	Base	Case	Pallet
M = mandatory C = conditional - = not used	-	M	M	M

T3799 Additional trade item identification type code

BMS ID	69			
Definition	Code specifying an additional trade item identification type.			

Description	<p>Use this attribute together with "T3798 Additional trade item identification" to provide a supplemental identification for the trade item. This attribute must always be used together with "T3798 Additional trade item identification", meaning that if T3798 is used then T3799 must also be used.</p> <p>Code value SUPPLIER_ASSIGNED is mandatory for orderable trade items for all recipients except Systembolaget.</p> <p>For Systembolaget, code value BUYER_ASSIGNED is instead mandatory.</p>			
Example	<p>To provide a supplier's trade item number, choose code "SUPPLIER_ASSIGNED" and enter the supplier's trade item number in "T3798 Additional trade item identification".</p>			
Code values	<p>Code value is specified according to code list T3799, see www.gs1.se/en-codelist-T3799.</p>			
Note	<p>Note that the information in the attribute may vary depending on the recipient.</p>			
Level	Component	Base	Case	Pallet
M = mandatory C = conditional - = not used	-	M	M	M

Global Model information

Group of attributes which provide information related to the Global Model Number (GMN).

Level	Component	Base	Case	Pallet
M = mandatory C = conditional - = not used	-	C	C	C

T4352 Global Model Number, GMN

BMS ID	6399			
Definition	Identity of the trade item's Global Model Number according to GS1's identification system.			
Description	Global Model Number is the GS1 identification key used to identify a product model or product family based on attributes common to the model or family as defined by industry or regulation. This GS1 identification key, once assigned to one product model or product family, SHALL NOT be reissued to another. The GMN SHALL NOT be used to identify a trade item.			
Level	Component	Base	Case	Pallet
M = mandatory C = conditional - = not used	-	M	M	M

T4353 Global Model description

BMS ID	6400			
Definition	The description of the base model. May deviate from the description of Trade Items derived from this model.			
Level	Component	Base	Case	Pallet

M = mandatory C = conditional - = not used	-	C	C	C
---	---	---	---	---

Trade item unit

This group of attributes is used to specify the hierarchical level of the trade item. Read more about trade item levels in chapter [Trade item levels in a trade item hierarchy](#).

Level	Component	Base	Case	Pallet
M = mandatory C = conditional - = not used	-	M	M	M

T4010 Trade item unit descriptor code

BMS ID	66			
Definition	Code indicating the hierarchical level of the trade item.			
Description	<p>This information is intended for the recipients as comprehensive information. However, there are no rules for other attributes that are based on these code values.</p> <p>Read more about trade item levels in chapter Trade item levels in a trade item hierarchy.</p>			
Example	<p>Examples of trade item levels:</p> <ul style="list-style-type: none"> • If the trade item hierarchy only has one level, that level is the base unit level. Example: An exclusive wine. • If the trade item hierarchy has two levels, it is comprised of a trade item at base unit level and a trade item at pallet level, even if the highest level is not a pallet or similar. Example: Beer shipped in a box or carton. • If the trade item hierarchy has three or more levels, it is comprised of a trade item at base unit level, a trade item at pallet level and one or more trade items at case level. Example: A multi-pack packaged in boxes and sold on a full-size pallet. 			
Code value	Code value is specified according to code list T4010, see www.gs1.se/en-codelist-T4010 .			
Level	Component	Base	Case	Pallet
M = mandatory C = conditional - = not used	-	M	M	M

T4012 Is trade item a base unit

BMS ID	56
Definition	Is trade item a base unit
Description	<p>A trade item at base unit level contains no other items identified with a GTIN (Global Trade Item Number).</p> <p>Read more about trade item levels in chapter Trade item levels in a trade item hierarchy</p>

Code value	true - base unit false - not a base unit			
Level	Component	Base	Case	Pallet
M = mandatory C = conditional - = not used		M	M	M

Product classification

This group is used to specify the classification category and product classification characteristics according to GPC (GS1 Global Product Classification).

GPC (Global Product Classification) is an international GS1 standard used to classify products into segment, family, class, and brick. The purpose is to create a common structure for product information globally, which facilitates searching, comparisons, and data quality.

The codes are determined by GS1's global working groups through the GSMP process and are updated twice a year.

Use the [GPC Browser](#) to search and view definitions of segment, family, class, and brick.

For more information on using GPC, see [GPC-Produktklasskategori](#).

Level	Component	Base	Case	Pallet
M = mandatory C = conditional - = not used	M	M	M	M

T0280 GPC category code

BMS ID	161			
Definition	Code indicating the classification category (brick code) for the trade item according to GPC.			
Description	<p>The attribute should always be specified once per item on all item levels. If a trade item consists of child trade items belonging to different product classes, use the most significant product class.</p> <p>For dietary supplements, select the appropriate GPC code in Segment 51000000 Healthcare. It is needed to enable entering certain types of dietary supplement information, such as being able to enter information per piece.</p>			
Example	10000051= Vinegars 10000159= Beer			
Level	Component	Base	Case	Pallet
M = mandatory C = conditional - = not used	M	M	M	M

Additional trade item classification

Alternative product classification system that can be specified in addition to GPC (GS1 Global Product Classification).

Level	Component	Base	Case	Pallet
-------	-----------	------	------	--------

M = mandatory C = conditional - = not used	-	C	C	-
---	---	---	---	---

T4238 Additional trade item classification system code

BMS ID	171			
Definition	Code indicating an additional trade item classification system			
Code value	Select a value from T4238 Additional trade item classification system code, see www.gs1.se/en-codelists-t4238 .			
Level	Component	Base	Case	Pallet
M = mandatory C = conditional - = not used	-	C	C	-

Additional trade item classification property

Characteristics that are associated with a class of trade items according to a taxonomy

Level	Component	Base	Case	Pallet
M = mandatory C = conditional - = not used	-	C	C	-

T4468 Additional trade item classification version

BMS ID	175			
Definition	The identification of a release of a particular product classification.			
Description	The attribute can be used to specify the ETIM version.			
Level	Component	Base	Case	Pallet
M = Mandatory C - Conditional - = Not used	-	C	C	-

T4469 Additional trade item classification property code

BMS ID	177			
Definition	Code assigned to a property of product for a classification.			
Definition	The attribute can be used to specify the ETIM characteristic.			
Code value	Code value for is specified according to code list T4469 Additional trade item classification property code			
Level	Component	Base	Case	Pallet
M = Mandatory C - Conditional - = Not used	-	C	C	-

T4470 Property float

BMS ID	193			
Definition	A property of a classification of an item expressed as a float for example 0.00.			
Definition	The attribute can be used to specify an ETIM attribute expressed as a decimal value.			
Level	Component	Base	Case	Pallet
M = Mandatory C - Conditional - = Not used	-	C	C	-

T4471 Property string

BMS ID	197			
Definition	A property of a classification of an item expressed as text.			
Definition	The attribute can be used to specify an ETIM attribute in free text.			
Level	Component	Base	Case	Pallet
M = Mandatory C - Conditional - = Not used	-	C	C	-

T4472 Property code

BMS ID	182			
Definition	A property of a classification of an item expressed as a code.			
Definition	The attribute can be used to specify an ETIM attribute in code value.			
Level	Component	Base	Case	Pallet
M = Mandatory C - Conditional - = Not used	-	C	C	-

Code for an additional trade item classification

Code values for an additional trade item classification

Level	Component	Base	Case	Pallet
M = mandatory C = conditional - = not used	-	C	C	-

T4239 Additional trade item classification code value

BMS ID	173			
Definition	Category code based on alternate classification schema chosen in addition to GS1 classification schema.			

Description	<p>The code is specified according to the product classification system specified in "T4238 Additional trade item classification system code".</p> <p>In Swedish implementation, the following codes in T4238 Additional trade item classification system code are used:</p> <p>75 for T4240 Product classification for calculation of alcohol tax code</p> <p>76 for T4484 Device risk class MDR/IVDR</p> <p>85 for T4485 Device risk class MDD/AIMDD/IVDD</p>			
Code value	<p>Code value is specified according to code list T4240 Product classification for calculation of alcohol tax, T4484 Device risk class MDR/IVDR or T4485 Device risk class MDD/AIMDD/IVDD</p>			
Level	Component	Base	Case	Pallet
M = mandatory C = conditional - = not used	-	M	M	-

T4486 Additional trade item classification code description

BMS ID	174			
Definition	Description of the additional classification bundle (code/agency + description).			
Description	Used together with T4239 Additional trade item classification code value			
Example	Designation of the supplier's grouping.			
Level	Component	Base	Case	Pallet
M = mandatory C = conditional - = Not used	-	V	V	-

Parties

This group refer to the identification of a party, by GLN and name in a specific party role and to different contacts by GLN, name and address in a business relation.

Level	Component	Base	Case	Pallet
M = mandatory C = conditional - = not used	-	C	C	C

T1115 Manufacturer of trade item, GLN

BMS ID	91			
Definition	Identity, according to GS1's identification system, of the party who is the manufacturer of the products.			
Description	Specify the GLN for the producer who manufactures the trade item			
Level	Component	Base	Case	Pallet
M = mandatory C = conditional - = not used	-	C	C	C

T3811 Manufacturer of trade item, name

BMS ID	93			
Definition	Name of the party who is the manufacturer of the product.			
Description	The attribute is only used, and must be used, when "T1115 Manufacturer identification, GLN" is used.			
Level	Component	Base	Case	Pallet
M = mandatory C = conditional - = not used	-	C	C	C

T3750 Brand owner, GLN

BMS ID	75			
Definition	Identity of the brand owner according to GS1's identification system.			
Description	The Brand owner may or may not be the same entity as the information provider. The attribute must be used when the buyer owns the brand.			
Level	Component	Base	Case	Pallet
M = mandatory C = conditional - = not used	-	C	C	C

T3752 Brand owner, name

BMS ID	77			
Definition	Name of the party who owns the brand of the trade item.			
Description	The attribute is only used, and must be used, when "T3750 Brand owner" is used.			
Level	Component	Base	Case	Pallet
M = mandatory C = conditional - = not used	-	C	C	C

Additional parties

This group of attributes refer to other parties in a business transaction and is used by entering the part, GLN, part, Name and party role from a code list. This group can be repeated with the attributes "T3786 Party, GLN", "T3787 Party, name" and "T3788 Party role code" in combination. Choose a party role code first in "T3788 Party role code" and then enter either T3786 or T3787 or both.

Level	Component	Base	Case	Pallet
M = mandatory C = conditional - = not used	-	C	C	C

T3786 Party, GLN

BMS ID	99			
Definition	Identity, according to GS1's identification system, of the party. The GLN is the primary party identifier. Each party identified in the trading relationship must have a primary party Identification.			
Description	<p>The GLN is the primary party identifier. Each party identified must have a GLN specified in this field.</p> <p>The attribute can be used in combination with "T3787 Party, name" and "T3788 Party role code".</p>			
Level	Component	Base	Case	Pallet
M = mandatory C = conditional - = not used	-	C	C	C

T3787 Party, name

BMS ID	101			
Definition	The name of the party.			
Description	The attribute can be used in conjunction with T3787 Party, name and T3788 Party role code			
Level	Component	Base	Case	Pallet
M = mandatory C = conditional - = not used	-	C	C	C

T4487 Party address

BMS ID	100			
Definition	The address associated with the party. This could be the full company address.			
Level	Component	Base	Case	Pallet
M = Mandatory C - Conditional - = Not used	-	C	C	C

T3788 Party role code

BMS ID	102			
Definition	A code that identifies the role of a party in a business transaction.			
Description	The attribute can be used in combination with "T3786 Party, GLN" and "T3787 Party, name".			
Code Value	<p>Code value is specified according to code list T3788, see www.gs1.se/en-codelist-T3788.</p> <p>For alcohol products, the following value may be used in the Swedish market: DISTRIBUTOR</p>			
Level	Component	Base	Case	Pallet

M = mandatory C = conditional - = not used	-	M	M	M
---	---	---	---	---

Contact Information

This group of attributes refer to contact details for a trade item. This group can be repeated with the attributes T3789, T3790, T3791 and T3792 in combination. Choose a contact type code first in T3792 and then enter either T3789 or T3790 or T3791 or in combination

Level	Component	Base	Case	Pallet
M = mandatory C = conditional - = not used	-	C	C	-

T3789 Contact GLN

BMS ID	128			
Definition	Identity of the party, according to GS1's identification system. The GLN is the primary contact identifier. Each contact identified in the trading relationship must have a primary contact Identification.			
Description	This identity is a GLN. Any contact identified in this field must have a GLN.			
Example	Example: Customer contact. Use code CYC customer support in T3792 and then enter GLN in T3789.			
Level	Component	Base	Case	Pallet
M = mandatory C = conditional - = not used	-	C	C	-

T3790 Contact name

BMS ID	126			
Definition	The name of the company or person associated with the contact type.			
Description	Read more about how the attribute is used in the separate Trade Item Information GPSR Guide .			

Example	<p>For example, in case of a contact type of consumer support, this could be the company name as expressed on the trade item packaging or label.</p> <p>Choose code CXC in "T3792 Contact type code" and then enter the name in "T3790 Contact name" and contact address in "T3791 Contact address".</p>			
Level	Component	Base	Case	Pallet
M = mandatory C = conditional - = not used	-	C	C	-

T3791 Contact address

BMS ID	123			
Definition	The address associated with the contact type.			
Description	Read more about how the attribute is used in the separate Trade Item Information GPSR Guide .			
Example	<p>For example, in case of a contact type of consumer support, this could be the full company address as expressed on the trade item packaging or label.</p> <p>Choose code CXC in "T3792 Contact type code" and then enter the name in "T3790" and contact address in "T3791 Contact address".</p>			
Level	Component	Base	Case	Pallet
M = mandatory C = conditional - = not used	-	C	C	-

T3792 Contact type code

BMS ID	127			
Definition	The general category of the contact party for a trade item.			
Description	Read more about how the attribute is used in the separate Trade Item Information GPSR Guide .			
Code value	Code value is specified according to code list T3792, see www.gs1.se/en-codelist-T3792 .			
Level	Component	Base	Case	Pallet
M = mandatory C = conditional - = not used	-	M	M	-

T4406 Target market country code

BMS ID	138			
Definition	The target market code indicates the country level or higher geographical definition in which the contact information is applicable.			
Description	Read more about how the attribute is used in the separate Trade Item Information GPSR Guide .			
Code value	<p>Code value is specified according to code list T3783 Target market country code.</p> <p>Code is specified according to ISO 3166-1 (three digit numeric).</p>			

Level	Component	Base	Case	Pallet
M = mandatory C = conditional - = not used	-	C	C	-

Communication channel

The group is used for specifying the channel or manner in which a communication can be made, such as telephone or email.

T4392 Communication channel code

BMS ID	134			
Definition	Code specifying the type of communication channel.			
Description	Read more about how the attribute is used in the separate Trade Item Information GPSR Guide . This attribute should be used together with "T4393 Communication value".			
Example	To enter the email address, enter the code value EMAIL in "T4392 Communication channel code" and the e-mail address in "T4393 Communication value".			
Code Value	Code value is specified according to code list T4392, see www.gs1.se/en-codelist-T4392 .			
Note	To specify a postal address, use the attribute <i>T3791 Contact address</i> .			
Level	Component	Base	Case	Pallet
M = mandatory C = conditional - = not used	-	C	C	-

T4393 Communication value

BMS ID	135			
Definition	Text identifying the endpoint for the communication channel.			
Description	Read more about how the attribute is used in the separate Trade Item Information GPSR Guide . This attribute should be used together with "T4392 Communication channel code".			
Example	To enter the email address, enter the code value EMAIL in "T4392 Communication channel code" and the e-mail address in "T4393 Communication value".			
Note	To specify a postal address, use the attribute <i>T3791 Contact address</i> .			
Level	Component	Base	Case	Pallet
M = mandatory C = conditional - = not used	-	C	C	-

Trade item status

This group of attributes is used to specify information about the trade item status, for example if the item is intended for ultimate consumption, if it is a despatch unit, and if and when it is orderable.

Level	Component	Base	Case	Pallet
M = mandatory C = conditional - = not used		M	M	M

T3495 Preliminary item status code

BMS ID	64			
Definition	A code designating whether the trade item has data that the information provider intends to correct or add values to due to pre-production unknowns (PRELIMINARY) or whether the item has attribute values that reflect go to market state (FINAL).			
Description	<p>The attribute is used to indicate whether the Trade Item Information is an announcement.</p> <p>If the attribute is entered with code PRELIMINARY, the attribute must be entered with code FINAL for the final version of Trade Item Information.</p> <p>If no code value is specified then the information is "Final" Trade Item Information.</p>			
Code value	Code value is specified according to code list T3495, see www.gs1.se/en-codelist-T3495 .			
Level	Component	Base	Case	Pallet
M = mandatory C = conditional - = not used	-	C	C	C

T4037 Is trade item a consumer unit

BMS ID	57			
Definition	Code indicating whether the trade item is intended for ultimate consumption.			
Code value	true - consumer unit false - not consumer unit			
Level	Component	Base	Case	Pallet
M = mandatory C = conditional - = not used	-	M	M	M

T0017 Is trade item an orderable unit

BMS ID	60			
Definition	Code indicating whether the trade item is orderable.			

Description	Orderable unit indicates whether the buyer can order this item from the supplier or not. In most cases the orderable trade item is the same as the invoice trade item but it does not have to be.			
Code value	true - orderable false - not orderable			
Note	Note that the information in the attribute may vary depending on the recipient.			
Level	Component	Base	Case	Pallet
M = mandatory C = conditional - = not used	-	M	M	M

T4038 Is trade item a despatch unit

BMS ID	58			
Definition	Code indicating whether the trade item can be a despatch unit.			
Code value	true - despatch unit false - not despatch unit			
Note	Note that the information in the attribute may vary depending on the recipient.			
Level	Component	Base	Case	Pallet
M = mandatory C = conditional - = not used	-	M	M	M

T4014 Is trade item an invoice unit

BMS ID	59			
Definition	Code indicating whether the trade item will be specified on the billing or invoice.			
Description	The invoice trade item is the same as an orderable trade item in most cases but it does not have to be.			
Code value	true - invoice unit false - not invoice unit			
Note	Note that the information in the attribute may vary depending on the recipient.			
Level	Component	Base	Case	Pallet
M = mandatory C = conditional - = not used	-	M	M	M

T0186 Is trade item a variable unit

BMS ID	3908			
Definition	Code indicating whether this is a variable measure item, that is, the quantity in the package is not fixed, and the price for the item varies with the quantity.			

Code value	true - variable measure item false - not variable measure item			
Level	Component	Base	Case	Pallet
M = mandatory C = conditional - = not used	-	M	M	M

T4430 Is trade item a promotional unit

BMS ID	2929			
Definition	An indicator used to point out those trade items which are promotions from regular line articles for example a bundle containing one bottle or shampoo and one of conditioner that is released for a three-month period will have to indicate 'true' in 'istradeitemapromotionalpackunit', while a soda six-pack would leave it blank or indicate 'no' as it is a regular trade item.			
Code value	true – promotional unit false – not a promotional unit			
Level	Component	Base	Case	Pallet
M = mandatory C = conditional - = Not used	-	V	V	-

T4119 Is trade item a service

BMS ID	61			
Definition	An indicator that the trade item is a service for example a receipt that can be used for upgrading a pre-paid phone balance, an entrance ticket to an amusement park, sporting event, theatre, service maintenance, installation service, repairs.			
Code value	true – a service false – not a service			
Level	Component	Base	Case	Pallet
M = mandatory C = conditional - = Not used	-	V	V	-

T2227 Consumer first availability date time

BMS ID	1001			
Definition	The first date and point of time at which a trade item is allowed to be sold to consumers.			
Description	Times are expressed in UTC (Coordinated Universal Time), with a UTC designator ("Z").			
Example	2017-09-13T10:46:13Z			
Note	Note that the information in the attribute may vary depending on the recipient.			
Level	Component	Base	Case	Pallet
M = mandatory C = conditional - = not used	-	C	C	C

T3742 First ship date time

BMS ID	1008			
Definition	The earliest date and point of time that the trade item can be shipped according to the delivery terms, independent of any specific ship-from location.			
Description	Times are expressed in UTC (Coordinated Universal Time), with a UTC designator ("Z").			
Example	2017-10-01T13:35:14Z			
Level	Component	Base	Case	Pallet
M = mandatory C = conditional - = not used	-	C	C	C

T4120 Is trade item seasonal

BMS ID	1550			
Definition	Code indicating whether the trade item is only offered during certain parts of the year or targeted to different seasons.			
Code value	true - trade item is seasonal false - trade item is not seasonal			
Level	Component	Base	Case	Pallet
M = mandatory C = conditional - = not used	-	C	C	C

T4121 Season parameter code

BMS ID	1556			
Definition	Code indicating the season the trade item is offered during or targeted for.			
Description	This attribute can be used if the trade item is seasonal, that is if the code value for "T4120 Is trade item seasonal" is "true".			
Code value	Code value is specified according to code list T4121, see www.gs1.se/en-codelist-T4121 .			
Level	Component	Base	Case	Pallet
M = mandatory C = conditional - = not used	-	C	C	C

T4727 Start availability date time

BMS ID	1025			
Definition	Date and point of time from when the item is available.			

Description	<p>For an orderable item the Start availability date time specifies the date and point of time from when an item will be available for ordering.</p> <p>The attribute should not be mixed-up with the launch date, which can be specified in "T2227 Consumer availability date time".</p> <p>Times are expressed in UTC (Coordinated Universal Time), with a UTC designator ("Z").</p>			
Example	2016-06-22T12:00:00Z			
Note	Note that the information in the attribute may vary depending on the recipient.			
Level	Component	Base	Case	Pallet
M = mandatory C = conditional - = not used	-	M	M	M

T4332 Is one time buy

BMS ID	1011			
Definition	Is the trade item a one time buy.			
Description	Indicates if the item will only be available for order once and then discontinued.			
Level	Component	Base	Case	Pallet
M = mandatory C = conditional - = not used	-	C	C	C

Sales conditions

This group of attributes can be used to specify sales conditions for the trade item.

Level	Component	Base	Case	Pallet
M = mandatory C = conditional - = not used	-	C	C	C

T4466 Consumer end availability date time

BMS ID	1028			
Definition	The last date/time that the trading partner is allowed to sell the trade item to consumers.			
Description	Times are expressed in UTC (Coordinated Universal Time), with a UTC designator ("Z").			
Level	Component	Base	Case	Pallet
M = Mandatory C - Conditional - = Not used	-	C	C	C

T4131 Consumer sales condition code

BMS ID	3325			
Definition	Code indicating restrictions imposed on the trade item regarding how it can be sold to the consumer.			

Description	A restriction can for example be that a prescription is needed, or that there is an age limit for purchasing the product.			
Code value	Code value is specified according to code list T4131, see www.gs1.se/en-codelist-T4131 .			
Level	Component	Base	Case	Pallet
M = mandatory C = conditional - = not used	-	C	C	C

T0147 Price comparison measurement

BMS ID	3330
Definition	The contents of the package when used or, where appropriate, after preparation.
Description	<p>The attribute is used for calculating comparison contents or price. What type of price comparison that can be calculated is specified in "T0145 Price comparison measurement code"</p> <p>This attribute is mandatory if the trade item is a consumer unit, to avoid misunderstanding, even if it is the same as "T0082 Net content".</p>
	<p>Read more about how the attribute is used in chapter Comparative price.</p> <p>Comparative equivalent content is not permitted to be changed without assigning the trade item a new GTIN (Global Trade Item Number). Read more about GS1's GTIN rules at www.gs1.org/gtinrules.</p>
Example	215.3

Code Value	Code value for comparison measurement unit is specified according to code list "T3780 Measurement unit code", see www.gs1.se/en-codelist-T3780 . For "T0147 Price comparison measurement unit" choose one of the code values: GRM – gram MLT – milliliter MMT – millimeter MTK – square meter MTQ – cubic meter H87 - piece			
Level	Component	Base	Case	Pallet
M = mandatory C = conditional - = not used	-	C	C	-

T0145 Price comparison content type code

BMS ID	3329
Definition	Code indicating how price comparison measurement can be calculated, or what kind of comparison of amount that can be made, based on the comparison measurement value.
Description	<p>This attribute is mandatory if the trade item is a consumer unit.</p> <p>The three attributes "T0147 Price comparison measurement", "T3780 Unit of measure for comparison measurement combined with T0147" and "T0145 Price comparison measurement code" are used as a basis for calculating the price comparison shown to the consumer. Read more about how these attributes are used in chapter Comparative price.</p> <p>Provide herring weight using code value "By drained weight." Read more in Fiskbranschens Riksförbunds "Branschriktlinjer för viktangivelse och mätning av sillvikt i inläggningar" at Livsmedelsverket or Fiskbranschens Riksförbund.</p>
Example	<p>A package of washing powder contains 800 gram. The price comparison is based on the contents expressed as a number of washes (21) allowing this to be presented to the consumer as price per wash:</p> <ul style="list-style-type: none"> ■ "T0082 Net content": 800 ■ "T3780 Unit of measure for net contents": GRM ■ "T0147 Price comparison measurement": 21 ■ "T3780 Unit of measure for comparison measurement": H87 (piece) ■ "T0145 Price comparison measurement code": PER_WASH <p>A multipack contains 10 ice creams (50g/piece). The price comparison is based on the content expressed as number of pieces (10) allowing this to be presented to the consumer as price per piece:</p> <ul style="list-style-type: none"> ■ "T0082 Net content": 500 ■ "T3780 Unit of measure for net contents": GRM ■ "T0147 Price comparison measurement": 10

	<ul style="list-style-type: none"> ■ "T3780 Unit of measure for comparison measurement": H87 (piece) ■ "T0145 Price comparison measurement code": PER_PIECE 			
Code value	The code value is based on the information in "T0147 Price comparison measurement". Code value is specified according to code list T0145, see www.gs1.se/en-codelist-T0145 .			
Note	More information and examples can be found at www.konsumentverket.se .			
Level	Component	Base	Case	Pallet
M = mandatory C = conditional - = not used	-	C	C	-

T4508 Is Base Price Declaration Relevant

BMS ID	3326			
Definition	An indicator whether this item is mandated to have price comparison information included according to country specific pricing directives.			
Code value	true – price comparison is relevant for the trade item false – price comparison is not relevant for the trade item			
Level	Component	Base	Case	Pallet
M = Mandatory C - Conditional - = Not used	-	C	C	-

T4461 Card price group identifier

BMS ID	3376			
Definition	A code that identifies a price			
Definition	The attribute may be used to group trade items that share the same sales price.			
Level	Component	Base	Case	Pallet
M = Mandatory C - Conditional - = Not used	-	C	C	-

T2229 Warranty duration

BMS ID	3976			
Definition	The time period that the warranty is valid within.			
Description	Warranty duration is stated in number of months, from the consumer's date of purchase.			
Code Value	Code value for measurement unit to T2229 is specified according to code list "T3780 Measurement unit code", see www.gs1.se/en-codelist-T3780 . For "T2229 Warranty duration" choose code value: MON – month			

Level	Component	Base	Case	Pallet
M = mandatory C = conditional - = not used	-	C	C	C

Distribution details

Delivery details for a trade item.

Level	Component	Base	Case	Pallet
M = mandatory C = conditional - = not used	-	C	C	C

T4475 Ordering lead time

BMS ID	1051			
Definition	Lead time required for orders expressed in days.			
Note	Code value for time is specified according to code list T3780 measurement unit code			
Level	Component	Base	Case	Pallet
M = Mandatory C - Conditional - = Not used	-	C	C	C

Delivery purchasing information

Purchasing and delivery information for a trade item.

Level	Component	Base	Case	Pallet
M = mandatory C = conditional - = not used	-	C	C	C

T4476 Order quantity minimum

BMS ID	1020			
Definition	Represent an agreed to minimum quantity of the trade item that can be ordered. A number or a count. This applies to each individual order. Can be a fixed amount for all customers in a target marke.			
Definition	Specified as a number or a quantity and applies to each individual order. It may be a fixed value for all customers within a target market.			
Level	Component	Base	Case	Pallet
M = Mandatory C - Conditional - = Not used	-	C	C	C

T4477 Last order date time

BMS ID	1016			
Definition	Indicates the latest date that an order can be placed for the trade item.			
Description	The attribute is used in communication with the Building Materials Trade Times are expressed in UTC (Coordinated Universal Time), with a UTC designator ("Z").			
Level	Component	Base	Case	Pallet
M = Mandatory C - Conditional - = Not used	-	C	C	C

T4506 Ordering Unit Of Measure

BMS ID	1018			
Definition	The alternate Unit of Measure of how Trade Items are ordered by the Retailer under one Unit of Measure, but sold under another Unit of Measure.			
Level	Component	Base	Case	Pallet
M = Mandatory C - Conditional - = Not used	-	C	C	C

T4507 Order Quantity Multiple

BMS ID	1021			
Definition	The order quantity multiples in which the trade item may be ordered. If the Order Quantity Minimum is 100, and the Order Quantity Multiple is 20, then the trade item can only be ordered in quantities which are divisible by the Order Quantity Multiple of 20.			
Level	Component	Base	Case	Pallet
M = Mandatory C - Conditional - = Not used	-	C	C	C

T4467 Order sizing factor

BMS ID	1022			
Definition	A trade item specification other than gross, net weight, or cubic feet for a line trade item or a transaction, used for order sizing and pricing purposes. For example, factors may be used to cube a truck, reflecting different weights, and dimensions of trade item.			
Description	Byggmaterialhandeln uses the term to indicate the packaging's volume in liters; it is used for logistics.			
Example	Packaging volume in liters T4467 Order sizing factor: 5 T3780 Measurement unit code: L			
Code value	Code value for measurement unit is specified according to code list T3780 Measurement unit code.			
Level	Component	Base	Case	Pallet
M = mandatory C = conditional - = Not used	-	V	V	-

T4726 End availability date time

BMS ID	1002			
Definition	The date and point of time from which an orderable trade item no longer can be ordered.			
Description	<p>The attribute can for example be used for promotions and seasonal items. The attribute is also used to notify selected recipients that the trade item will be discontinued. The attribute should not be used for trade items that are discontinued for all recipients. In those cases, "T4015 Discontinued date time" should be used.</p> <p>The attribute shall also be specified for other items in the hierarchy which will cease to be delivered when the orderable item is no longer available.</p> <p>Times are expressed in UTC (Coordinated Universal Time), with a UTC designator ("Z").</p> <p>Read more about how this attribute is used for seasonal items in section Seasonal goods.</p>			
Example	<p>2017-04-31T12:00:00Z</p> <p>An item hierarchy consists of:</p> <ul style="list-style-type: none"> ■ Base unit: Bottle of shampoo. ■ Case level: Case of bottles of shampoo (orderable item). ■ Pallet level: Pallet of cases of bottles of shampoo. <p>The last date for ordering a case is 2017-04-31. Consequently, the pallet of cases will cease to be delivered on the same date. End availability date time must therefore be specified for both the case and pallet. The base unit, a bottle of shampoo, is part of another hierarchy and can still be delivered. Therefore, End availability date time shall not be specified for the bottle.</p>			
Note	Note that the information in the attribute may vary depending on therecipient.			
Level	Component	Base	Case	Pallet
M = mandatory C = conditional - = not used	-	C	C	C

T4015 Discontinued date time

BMS ID	143			
Definition	The date and time on which the trade item is no longer available to the buyer.			
Description	<p>The attribute is mandatory for trade items that are discontinued for all recipients. For trade items that are discontinued for selected recipients, "T4726 End availability date time" should be used instead.</p> <p>Times are expressed in UTC (Coordinated Universal Time), with a UTC designator ("Z").</p>			
Example	2017-03-15T12:00:00Z			
Level	Component	Base	Case	Pallet

M = mandatory C = conditional - = not used	-	C	C	C
---	---	---	---	---

Product characteristics

This group of attributes can be used to specify information about various product characteristics.

Level	Component	Base	Case	Pallet
M = mandatory C = conditional - = not used	-	C	C	C

T4144 Are hazardous components removable

BMS ID	3565			
Definition	An indicator if any hazardous components contained within the trade item can easily be separated from the other materials to facilitate product recycling.			
Code value	true - hazardous components are removable false - hazardous components are not removable			
Level	Component	Base	Case	Pallet
M = mandatory C = conditional - = not used	-	C	-	-

T4445 Waste code

BMS ID	7176			
Definition	The code that describes the type of waste created from the product. Please refer to any local regulation requirements for disposal/recyclable waste.			
Description	Type of waste specified in the product's Instructions for Use (IFU).			
Code value	Code value is specified according to code list: T4445 Waste code			
OBS!	This attribute is part of the ECHO data model; for further guidance and detailed information, see: Common ECHO data model.			
Level	Component	Base	Case	Pallet
M = Mandatory C = Conditional - = not used	-	C	C	-

T4265 Product characteristic code

BMS ID	2857			
Definition	The name of the product characteristic being described			

Description	<p>Used to indicate that a product has certain properties, together with the additional attributes specified below.</p> <p>Use this attribute to specify the type of information that is being provided, and one of the below attributes to specify the associated value:</p> <ul style="list-style-type: none"> ▪ T4300 Product characteristic value measurement ▪ T4301 Product characteristic value integer ▪ T4324 Product characteristic value description 			
Code value	Code list "T4265 Product characteristic code", see www.gs1.se/en-codelist-T4265 .			
Level	Component	Base	Case	Pallet
M = mandatory C = conditional - = not used	-	C	-	-

T4324 Product characteristic value description

BMS ID	2862			
Definition	Description of the characteristic of a product.			
Description	The product characteristic value expressed as a description. Use this attribute when "T4265 Product Characterstic code" requires a product description in free text.			
Code Value	Code value for language is specified according to code list "T3782 Language code" see www.gs1.se/en-codelist-T3782 .			
Level	Component	Base	Case	Pallet
M = mandatory C = conditional - = not used	-	C	-	-

T4300 Product characteristic value measurement

BMS ID	2864			
Definition	The product characteristic value expressed as a measurement			
Description	Use this attribute to provide the value associated with "T4265 Product characteristic code" if T4265 requires a measurement.			
Example	<p>To provide the average life of a product, use code value "averageLife" for "T4265 Product characteristic code" and for "T4300 Product characteristic value measurement" enter the average life of the product together with an appropriate unit of measure.</p> <p>Example: 200 hours</p>			
Code value	Code value is specified according to code list T3780, see http://www.gs1.se/en-codelist-T3780 .			
Level	Component	Base	Case	Pallet
M = mandatory C = conditional - = not used	-	C	-	-

T4301 Product characteristic value integer

BMS ID	5460			
Definition	The product characteristic value expressed as an integer.			
Description	Use this attribute to provide the value associated with "T4265 Product characteristic code" if T4265 requires an integer.			
Example	For example, to provide the number of burners on a stove, , for "T4265 Product characteristic code" use code values "numberOfBurners", and for "T4301 Product characteristic value integer" enter the number of burners. Example: 3			
Level	Component	Base	Case	Pallet
M = mandatory C = conditional - = not used	-	C	-	-

T4327 Grade code reference

BMS ID	1506			
Definition	A code indicating the quality of a trade item.			
Description	A code indicating the degree of refinement, features, or capabilities for a trade item.			
Example	The quality grade of a ceramic tile or of a food item such as eggs.			
Code Value	Code value is specified according to code list T4327, see www.gs1.se/en-codelist-T4327			
Level	Component	Base	Case	Pallet
M = mandatory C = conditional - = not used	-	C	C	-

T4328 Grade code reference agency

BMS ID	1508			
Definition	A code representing the agency which manages the code list.			
Code Value	Code value is specified according to code list T4328, see www.gs1.se/en-codelist-T4328			
Level	Component	Base	Case	Pallet
M = mandatory C = conditional - = not used	-	C	C	-

T2522 Is trade item RoHS compliant

BMS ID	2518			
Definition	Code indicating whether the product is compliant with the European Union RoHS Directive.			
Description	RoHS restricts the use of certain hazardous substances in electrical and electronic equipment. The RoHS bans the placing on the EU market of new electrical and electronic equipment containing more than agreed levels of lead, cadmium, mercury, hexavalent chromium, polybrominated biphenyl (PBB) and polybrominated diphenyl ether (PBDE) flame retardants.			

Code value	true - trade item complies to RoHS directive false - trade item does not comply to RoHS directive			
Level	Component	Base	Case	Pallet
M = mandatory C = conditional - = not used	-	C	-	-

Carbon footprint header

This group of attributes can be used to specify information about carbon footprint.

Level	Component	Base	Case	Pallet
M = mandatory C = conditional - = not used	-	C	C	C

T4415 Cfp country code

BMS ID	8728			
Definition	The code specifying a target market for which the carbon footprint values have been calculated. Transportation emissions can greatly vary from country to country.			
Description	Read more about how the attribute is used in the separate Guideline for information about carbon footprint .			
Code value	Code value is specified according to code list T3784, see www.gs1.se/en-codelist-T3784 . Code is specified according to ISO 3166-1 (three digit numeric).			
Level	Component	Base	Case	Pallet
M = mandatory C = conditional - = not used	-	C	C	C

T4416 Cfp date

BMS ID	8730			
Definition	The date on which the product carbon footprint assessment was conducted.			
Description	Read more about how the attribute is used in the separate Guideline for information about carbon footprint . Times are expressed in UTC (Coordinated Universal Time), with a UTC designator ("Z").			
Example	2024-05-31T00:00:00Z			
Level	Component	Base	Case	Pallet

M = mandatory C = conditional - = not used	-	C	C	C
---	---	---	---	---

T4417 Cfp value verification code

BMS ID	8731			
Definition	The code indicating how the calculated carbon footprint value is verified.			
Description	Read more about how the attribute is used in the separate Guideline for information about carbon footprint .			
Code Value	Code value is specified according to code list T4417 Cfp value verification code .			
Level	Component	Base	Case	Pallet
M = mandatory C = conditional - = not used	-	C	C	C

T4418 Cfp boundaries code

BMS ID	8734			
Definition	The code identifying the life cycle stage that the product carbon footprint value refers to. The boundary setting may vary depending on the purpose of the product carbon footprint assessment.			
Description	Read more about how the attribute is used in the separate Guideline for information about carbon footprint .			
Code Value	Code value is specified according to code list T4418 Cfp boundaries code .			
Level	Component	Base	Case	Pallet
M = mandatory C = conditional - = not used	-	C	C	C

T4419 Cfp value

BMS ID	8736
Definition	The emissions value, i.e., carbon footprint, for a specific boundary setting.
Description	Read more about how the attribute is used in the separate Guideline for information about carbon footprint .
Example	For 0,4 kg CO2 per kg specify: T4419: 0.4 T4423: KG_CO2_EQ_PER_KG
Note	If the measurement unit code for the value of "T4419 Cfp value" = KG_CO2_EQ_PER_FU, "T4420 Cfp functional unit" shall be used.

Code Value	Code value for measurement unit is specified according to code list T4423 Cfp value measurement unit code .			
Level	Component	Base	Case	Pallet
M = mandatory C = conditional - = not used	-	C	C	C

T4420 Cfp functional unit

BMS ID	8739			
Definition	The functional unit describes the quantity and/or performance characteristics of a product as it is used by the end-user, which forms the basis for calculating the emissions value (i.e., carbon footprint), and can be used for comparison to other similar products.			
Description	Read more about how the attribute is used in the separate Guideline for information about carbon footprint .			
Note	<p>The attribute is only used if the measurement unit code for the value of "T4419 Cfp value" = KG_CO2_EQ_PER_FU.</p> <p>Allows for the representation of the same value in different languages, but not for multiple values.</p>			
Level	Component	Base	Case	Pallet
M = mandatory C = conditional - = not used	-	C	C	C

T4421 Cfp methodology code

BMS ID	8742			
Definition	The code specifying the method used to assess and communicate the environmental impact of the product in terms of carbon footprint.			
Description	Read more about how the attribute is used in the separate Guideline for information about carbon footprint .			
Code Value	Code value is specified according to code list T4421 Cfp methodology code .			
Level	Component	Base	Case	Pallet
M = mandatory C = conditional - = not used	-	C	C	C

T4427 Does carbon footprint include packaging

BMS ID	8847			
Definition	The indicator specifying if the carbon footprint calculation includes packaging.			
Code Value	true – packaging is included false – packaging is not included			
Description	Read more about how the attribute is used in the separate Guideline for information about carbon footprint.			
Level	Komponent	Bas	Mellan	Topp
M = mandatory C = conditional - = not used	-	C	C	-

T4422 Cfp accounting code

BMS ID	8744			
Definition	The code indicating which method is used to conduct the lifecycle assessment for carbon footprint calculation.			
Description	Read more about how the attribute is used in the separate Guideline for information about carbon footprint.			
Example	ATTRIBUTIONAL – Kartläggande			
Code Value	Code value is specified according to code list T4422 Cfp accounting code.			
Level	Component	Base	Case	Pallet
M = mandatory C = conditional - = not used	-	C	C	C

T3778 Chemical ingredient name

BMS ID	3189			
Definition	The common name of the chemical ingredient.			
Description	Use the common name of the chemical ingredient.			
Example	If the trade item contains Polyvinylklorid then enter PVC.			
Level	Component	Base	Case	Pallet
M = mandatory C = conditional - = not used	-	C	-	-

T3826 Trade item feature code reference

BMS ID	1514			
Definition	A code depicting a distinctive functionality offered as a special attraction to the trade item.			

Description	The trade item feature code reference can be used to inform about a specific functionality that the trade item possesses.			
Code Value	Code list "T3826 Trade item feature code reference", see www.gs1.se/en-codelist-T3826 .			
Level	Component	Base	Case	Pallet
M = mandatory C = conditional - = not used	-	C	-	-

T3746 Trade item marketing message

BMS ID	1498			
Definition	Marketing message associated with the trade item.			
Description	Used to specify a marketing message for the trade item. Always specify the information in Swedish.			
Note	"T3746 Trade item marketing message" is the primary attribute used to market trade items in the Swedish market. If the buyer also requires a short marketing message, specify this in "T4233 Short trade item marketing message". Check with your buyer which marketing message(s) are required.			
Level	Component	Base	Case	Pallet
M = mandatory C = conditional - = not used	-	C	C	-

T4233 Short trade item marketing message

BMS ID	1525			
Definition	A short marketing message associated with the trade item			
Description	The attribute can be used to create short marketing messages in a bullet list. Specify the information in Swedish.			
Note	"T3746 Trade item marketing message" is the primary attribute used to market trade items in the Swedish market. Check with your buyer which marketing message(s) are required.			
Level	Component	Base	Case	Pallet
M = mandatory C = conditional - = not used	-	C	C	-

T4204 Trade item key words

BMS ID	1530			
Definition	Words or phrases that enables web search engines to find trade items on the internet			

Description	Words or phrases that the consumer may use to search for products online. Use commas to separate search terms, without adding any spaces between individual terms.			
Example	Product: Chokladmjölk "chokladmjölk,smaksatt mjölk,choklad,dryckchoklad,chokladdryck"			
Note	Search terms should be used to find the company's products. It is not permitted to use search terms to include/link other brands and/or products, e.g. by writing another company's brand names and/or product names on their own products' search terms.			
Level	Component	Base	Case	Pallet
M = mandatory C = conditional - = not used	-	C	C	-

T4294 Designer

BMS ID	1500			
Definition	The person or company that designed the product. This may or may not be the brand name as designers.			
Description	The attribute can be repeated with different content and in different languages.			
Example	Louis Vuitton, Ulrica Hydman Vallien			
Level	Component	Base	Case	Pallet
M = mandatory C = conditional - = not used	-	C	C	-

T4302 Trade item finish description

BMS ID	1127			
Definition	An attribute which defines the outer surface/appearance of the product.			
Description	Specify the information in Swedish. The information may be provided in additional languages, but only once per language.			
Example	Lack			
Level	Component	Base	Case	Pallet
M = mandatory C = conditional - = not used	-	C	C	-

T4276 Target consumer usage type code

BMS ID	6174			
Definition	A code identifying the type of usage criteria for the target consumer that will use the product			

Description	Use with T4277 Target consumer minimum usage criteria and/or T4278 Target consumer maximum usage criteria to describe a property of the consumer for which the product is intended. Provide the target consumer criteria using T4276 and provide in T4277 and/or T4278 the lowest and highest value associated with the criteria.			
Example	Age Height Weight			
Code Value	Provide a code value from code list T4276, see www.gs1.se/en-codelist-t4276			
Level	Component	Base	Case	Pallet
M = mandatory C = conditional - = not used	-	C	C	-

T4277 Target consumer minimum usage

BMS ID	6170			
Definition	Measurement of the minimum usage criteria for the target consumer that will use the product			
Description	Use with T4276 Target consumer usage type code. Provide in T4277 the lowest value associated with the target consumer usage type that you have chosen in T4276. This attribute requires a unit of measure specific to the target consumer usage type chosen in T4276, see "Code Value" section below for examples.			
Example	170 cm			
Code Value	Provide a code value from code list T3780 Measurement unit code, see www.gs1.se/en-codelist-t3780 . For age in "T4276 Target consumer usage type code" choose code value: ANN – Year. For height in "T4276 Target consumer usage type code" choose code value: CMT – Centimeter. For weight in "T4276 Target consumer usage type code" choose code value: KGM – Kilogram.			
Level	Component	Base	Case	Pallet
M = mandatory C = conditional - = not used	-	C	C	-

T4278 Target consumer maximum usage

BMS ID	6172			
Definition	Measurement of the maximum usage criteria for the target consumer that will use the product			
Description	Use with T4276 Target consumer usage type code. Provide in T4278 the highest value associated with the target consumer usage type that you have chosen in T4276. This attribute requires a unit of measure specific to the target consumer usage type chosen in T4276, see "Code Value" section below for examples.			

Example	190 cm			
Code Value	Provide a code value from code list T3780 Measurement unit code, see www.gs1.se/en-codelist-t3780 . For age in "T4276 Target consumer usage type code" choose code value: ANN – Year. For height in "T4276 Target consumer usage type code" choose code value: CMT – Centimeter. For weight in "T4276 Target consumer usage type code" choose code value: KGM – Kilogram.			
Level	Component	Base	Case	Pallet
M = mandatory C = conditional - = not used	-	C	C	-

T4331 Target consumer gender

BMS ID	1560			
Definition	The gender of the consumer for which a product has been designed.			
Code Value	Code value is specified according to code list T4331, see www.gs1.se/en-codelist-T4331			
Level	Component	Base	Case	Pallet
M = mandatory C = conditional - = not used	-	C	C	-

T3775 Consumer storage instructions

BMS ID	789			
Definition	Expresses in text the consumer storage instructions of a product which are normally held on the label or accompanying the product. This information may or may not be labeled on the pack.			
Description	Instructions may refer to a suggested storage temperature, a specific storage requirement. Always specify the information in Swedish.			
Example	"Förvara i kylskåp efter öppning" "Utsätt ej för direkt solljus"			
Note	Allows for the representation of the same value in different languages, but not for multiple values.			
Level	Component	Base	Case	Pallet
M = mandatory C = conditional - = not used	-	C	C	C

T3776 Consumer usage instructions

BMS ID	791			
---------------	-----	--	--	--

Definition	Expresses in text the consumer usage instructions of a product which are normally held on the label or accompanying the product. This information may or may not be labeled on the pack.			
Description	Instructions may refer to how the consumer is to use the product. This does not include storage, food preparations, and drug dosage and preparation instructions. Always specify the information in Swedish.			
Example	"Konsumera inom 4 dagar" "Applicera först foundation längs ansiktets mitt. Använd bara en liten mängd foundation och massera in ordentligt i huden."			
Note	Allows for the representation of the same value in different languages, but not for multiple values.			
Level	Component	Base	Case	Pallet
M = mandatory C = conditional - = not used	-	C	C	C

T4306 Consumer recycling instructions

BMS ID	6300			
Definition	Expresses in text the consumer recycling instructions.			
Description	Instructions are normally on the label or accompany the product. They may refer to how the consumer is supposed to sort the product and packaging materials for recycling.			
Example	"Sortera som plast" "Sortera kork och topp som plast och resten av förpackningen som papper"			
Note	Allows for the representation of the same value in different languages, but not for multiple values.			
Level	Component	Base	Case	Pallet
M = mandatory C = conditional - = not used	-	C	C	C

T5036 Non-food ingredient statement

BMS ID	1623			
Definition	Information on the constituent non-food ingredient make-up of the product specified as one string.			
Description	The attribute is used to specify the ingredients printed on the package. If the ingredients are specified for a non-food item and the item is intended to be sold in Sweden then the information must follow relevant Swedish legislation and rules. Specify the information in Swedish.			

Note	<p>If there is a short and a long ingredient statement on the package, both must be specified in the Trade Item Information.</p> <p>The attribute is applicable to non-food. For food, use "T4088 Ingredient statement". For animal feed, use "T4248 Feed composition statement".</p> <p>May be repeated with different content and in different languages.</p>			
Level	Component	Base	Case	Pallet
M = mandatory C = conditional - = not used	C	C	C	-

T4205 Non-food ingredient name

BMS ID	1635			
Definition	The name of the non-food ingredient.			
Description	Can be used in combination with the T4206 "Is active ingredient".			
Example	Acetylsalicylic acid			
Note	Allows for the representation of the same value in different languages.			
Level	Component	Base	Case	Pallet
M = mandatory C = conditional - = not used	-	C	C	-

T4206 Is ingredient active

BMS ID	1633			
Definition	Determines whether the ingredient helps directly in achieving the objectives of the trade item.			
Description	Active substance is the substance of a drug, herbal or other product that gives its medical effect.			
Example	A product can have several active substances, such as "aspirin containing acetylsalicylic acid and caffeine".			
Code Value	true - the ingredient is active false - the ingredient is not active			
Level	Component	Base	Case	Pallet
M = mandatory C = conditional - = not used	-	C	C	-

Alcohol information

Contains information about alcoholic products.

Level	Component	Base	Case	Pallet
M = mandatory C = conditional - = not used	C	C	C	-

T2208 Percentage of alcohol by volume

BMS ID	352			
Definition	Actual percentage of alcohol contained in the product.			
Description	<p>State the alcohol percentage indicated on the product label.</p> <p>The attribute must be used for items where alcohol percentage must be reported. The alcohol percentage is given in accordance with the Swedish Food Agency recommendations.</p> <p>The alcohol percentage should be stated with a period (.) as a decimal point.</p> <p>The tax amount can be calculated from the Swedish Tax Authority's rules based on the percentage of alcohol, volume ("T0082 Net content") and product type ("T0280 GPC category code").</p> <p>If this attribute is used, percentage of alcohol by volume shall be entered as part of the description short in "T3337 Description short".</p>			
Example	3,5% is stated as 3.5			
Level	Component	Base	Case	Pallet
M = mandatory C = conditional - = not used	C	C	C	-

T4203 Vintage

BMS ID	357			
Definition	The year in which the majority of ingredients are harvested and/or the alcoholic beverage is produced. Determination as to whether the vintage year is the harvest date or production date is according to requirements in the Target Market			
Description	<p>States the year in which most of a wine's ingredients were harvested, and/or the year in which the alcoholic drink was produced.</p> <p>Applies primarily to vintage wines.</p>			
Example	1995			
Level	Component	Base	Case	Pallet
M = mandatory C = conditional - = not used	C	C	C	-

T4271 Alcoholic beverage sugar content

BMS ID	355			
Definition	Indication of the amount of sugar contained in the beverage.			
Example	6			

Code value	Code value for measurement unit is specified according to code list "T3780 Measurement unit code", see http://www.gs1.se/en-codelist-T3780 . For "T4271 Alcoholic beverage sugar content" choose code value: GL – gram per litre			
Level	Component	Base	Case	Pallet
M = mandatory C = conditional - = not used	C	C	C	-

T4315 Bitterness of beer measurement

BMS ID	6570			
Definition	Description of the bitterness of beer.			
Description	Description used by the product manufacturer to identify the bitterness of beer, expressed in IBU and/or EBU .			
Level	Component	Base	Case	Pallet
M = mandatory C = conditional - = not used	C	C	C	-

T4333 Bitterness of beer measurement unit code

BMS ID	6571			
Definition	Measurement unit code for bitterness of beer.			
Code Value	Code value is specified according to code list T4333, se www.gs1.se/en-codelist_T4333			
Level	Component	Base	Case	Pallet
M = mandatory C = conditional - = not used	C	C	C	-

T4316 Alcoholic beverage age

BMS ID	6321			
Definition	The time period which the alcoholic beverage has been aged.			
Example	12 år			
Code Value	Code value for measurement unit is specified according to code list "T4270 Time measurement unit code", see https://www.gs1.se/en-codelist-t4270			
Level	Component	Base	Case	Pallet
M = mandatory C = conditional - = not used	C	C	C	-

T4317 Alcohol beverage distilled from code

BMS ID	6318			
Definition	Main ingredient(s) from which the alcohol product has been distilled.			

Example	Råg, potatis, sockerrör			
Code Value	Code value is specified according to code list T4317, see www.gs1.se/en-codelist-T4317			
Level	Component	Base	Case	Pallet
M = mandatory C = conditional - = not used	C	C	C	-

T4318 Alcohol beverage filtering method type code

BMS ID	6316			
Definition	The method by which an alcoholic beverage has been filtered.			
Exempel	Träkol, kyld			
Code Value	Code value is specified according to code list T4318, see www.gs1.se/en-codelist-T4318			
Level	Component	Base	Case	Pallet
M = mandatory C = conditional - = not used	C	C	C	-

T4319 Alcohol beverage production method type code

BMS ID	6317			
Definition	Production method for an alcoholic beverage.			
Example	Traditionell metod, Kolsyremetod, Chamenoise			
Code Value	Code value is specified according to code list T4319, see www.gs1.se/en-codelist-T4319			
Level	Component	Base	Case	Pallet
M = mandatory C = conditional - = not used	C	C	C	-

T4322 Sweetness level of alcoholic beverage code

BMS ID	6574			
Definition	Code indicating the level of sweetness in an alcoholic beverage.			
Description	Description used by the product manufacturer to identify the sweetness of an alcoholic beverage.			
Example	Brut, Halvtorr			
Code Value	Code value is specified according to code list T4322, see www.gs1.se/en-codelist-T4322			
Level	Component	Base	Case	Pallet
M = mandatory C = conditional - = not used	C	C	C	-

T4323 Origin of wine code

BMS ID	6572			
Definition	Code indicating the country, region and sub-region where a wine has been produced.			
Description	The country, region and sub-region where a wine has been produced.			
Example	Frankrike - Bordeaux - Bergerac			
Note	Country of origin is required for all alcoholic beverages and should always be specified in "T0168 Country of origin".			
Code Value	Code value is specified according to code list T4323, see www.gs1.se/en-codelist-T4323			
Level	Component	Base	Case	Pallet
M = mandatory C = conditional - = not used	C	C	C	-

Beauty personal care hygiene detail

The group of attributes is used to provide information on beauty, personal care and hygiene details.

Level	Component	Base	Case	Pallet
M = mandatory C = conditional - = not used	-	C	C	-

T4345 Formation type code

BMS ID	6528			
Definition	The state in which the product is sold.			
Example	Lotion, Mousse, Powder, Gel, Liquid			
Code value	Code value is specified according to codelist T4345, see www.gs1.se/en-codelist-T4345			
Level	Component	Base	Case	Pallet
M = mandatory C = conditional - = not used	-	C	C	-

T4346 Time of application code

BMS ID	6529			
Definition	The time when the product should be applied.			
Code value	Code value is specified according to codelist T4346, see www.gs1.se/en-codelist-T4346			
Level	Component	Base	Case	Pallet
M = mandatory C = conditional - = not used	-	C	C	-

T4347 Skin product function or treatment code

BMS ID	6552			
Definition	The function of a skin care product.			
Example	Anti-aging, Moisturising, Sun protection			
Code value	Code value is specified according to codelist T4347, see www.gs1.se/en-codelist-T4347			
Level	Component	Base	Case	Pallet
M = mandatory C = conditional - = not used	-	C	C	-

T4348 Target skin type code

BMS ID	6552			
Definition	The type of skin the product is intended for.			
Example	Dry, Normal, Oily			
Code value	Code value is specified according to codelist T4348, see www.gs1.se/en-codelist-T4348			
Level	Component	Base	Case	Pallet
M = mandatory C = conditional - = not used	-	C	C	-

T4349 Hair product function or treatment code

BMS ID	6548			
Definition	The function of a hair care product.			
Example	Anti-frizz, Anti-dandruff			
Code value	Code value is specified according to codelist T4349, see www.gs1.se/en-codelist-T4349			
Level	Component	Base	Case	Pallet
M = mandatory C = conditional - = not used	-	C	C	-

T4350 Target hair type code

BMS ID	6549			
Definition	The type of hair the product is intended for.			
Example	Curly, Dry, Relaxed			
Code value	Code value is specified according to codelist T4350, see www.gs1.se/en-codelist-T4350			
Level	Component	Base	Case	Pallet
M = mandatory C = conditional - = not used	-	C	C	-

T4351 Natural hair colour code

BMS ID	6550			
Definition	The natural colour of the hair for which the product is intended.			

Example	Blonde, Grey, Brown			
Code value	Code value is specified according to codelist T4351, see www.gs1.se/en-codelist-T4351			
Level	Component	Base	Case	Pallet
M = mandatory C = conditional - = not used	-	C	C	-

Video display device information

Contains information about the capabilities of a trade item that displays visual images, for example a television or computer monitor.

Level	Component	Base	Case	Pallet
M = mandatory C = conditional - = not used	-	C	-	-

T4298 Screen refresh rate

BMS ID	3929			
Definition	The number of times a display's image is repainted or refreshed per second measured in Hertz.			
Example	60 hertz			
Level	Component	Base	Case	Pallet
M = mandatory C = conditional - = not used	-	C	-	-

T4299 Display screen size

BMS ID	3943			
Definition	The viewable display/screen size of the product expressed as a measurement.			
Example	48 inches			
Code value	Code value for measurement unit is specified according to code list T3780, see http://www.gs1.se/en-codelist-T3780 . For "T4299 Display screen size" choose code values: INH – inches or CMT – centimeters.			
Level	Component	Base	Case	Pallet
M = mandatory C = conditional - = not used	-	C	-	-

Audio visual media product information

Information on the genre and content of an entertainment-related product (e.g. movies, music) including format and genre.

Level	Component	Base	Case	Pallet
M = mandatory C = conditional - = not used	-	C	-	-

T4287 Genre type code reference

BMS ID	217			
Definition	The code of the genre of media item			
Description	The genre is a categorization of the trade item based upon the content and is maintained for marketing and merchandising purposes.			
Example	For a film: Film Action Comedy For a video game: Game Fighting For a music product: Music Dance Electronica			
Code value	The code list used differs based on product: <ul style="list-style-type: none"> • T4288 - Product Genre Type Code (Film) • T4289 - Product Genre Type Code (Electronic Games) • T4290 - Product Genre Type Code (Music) 			
Note	It is permitted to provide multiple values from the same code list to indicate that the media item has more than one genre. However, it is not permitted to provide multiple values from different code lists. For example, if a value(s) is provided from the "T4289 Product Genre Type Code (Electronic Games)" code list, then it is not permitted to provide values from either the "T4288 Product Genre Type Code (Film)" or the "T4290 Product Genre Type Code (Music)" code lists in addition.			
Level	Component	Base	Case	Pallet
M = mandatory C = conditional - = not used	-	C	-	-

Battery type information

This group of attributes refers to battery information for a trade item.

Level	Component	Base	Case	Pallet
M = mandatory C = conditional - = not used	-	C	-	-

T3800 Are batteries included

BMS ID	600			
Definition	Indicates if batteries are either included or not included with the trade item.			
Level	Component	Base	Case	Pallet
M = mandatory C = conditional - = not used	-	C	-	-

T3801 Are batteries required

BMS ID	601			
Definition	Indicates if batteries are required to operate the trade item.			
Level	Component	Base	Case	Pallet
M = mandatory C = conditional - = not used	-	C	-	-

T3802 Are batteries built in

BMS ID	612			
Definition	This code is defined as an indicator whether or not any batteries included with the trade item are built into the trade item during manufacturing and cannot be changed or removed.			
Level	Component	Base	Case	Pallet
M = mandatory C = conditional - = not used	-	C	-	-

T4750 Quantity of batteries built in

BMS ID	617			
Definition	The quantity of batteries built into the trade item during manufacturing. This includes batteries that can or cannot be changed or removed.			
Level	Component	Base	Case	Pallet
M = mandatory C = conditional - = not used	-	C	-	-

T3803 Battery technology type code

BMS ID	613			
Definition	The type of battery family of batteries used by the product.			
Description	Repeatable per battery technology type contained in the trade item			
Example	Lithium, NiMH			
Code Value	Code value is specified according to code list T3803, see www.gs1.se/en-codelist-T3803 .			
Level	Component	Base	Case	Pallet
M = mandatory C = conditional - = not used	-	C	-	-

T3804 Battery type code

BMS ID	614			
Definition	Type of battery required to operate the game.			

Description	If "T3801 Are Batteries Required" or if "T3805 Quantity of Batteries" is populated or if "T3800 Are Batteries Included" = "Yes" this attribute is required.			
Code Value	Code value is specified according to code list T3804, see www.gs1.se/en-codelist-T3804 .			
Level	Component	Base	Case	Pallet
M = mandatory C = conditional - = not used	-	C	-	-

T3805 Quantity of batteries required

BMS ID	618			
Definition	The number of batteries required to operate the trade item.			
Level	Component	Base	Case	Pallet
M = mandatory C = conditional - = not used	-	C	-	-

T4147 Battery weight

BMS ID	615			
Definition	The weight of each battery included with or built into the trade item.			
Description	The weight is stated in grams.			
Example	11.5			
Code Value	Code value for measurement unit is specified according to code list "T3780 Measurement unit code", see www.gs1.se/en-codelist-T3780 . For "T4147 Battery Weight" choose code value: GRM - gram			
Level	Component	Base	Case	Pallet
M = mandatory C = conditional - = not used	-	C	-	-

Lighting device information

A module including attributes related to lighting devices, such as lamps.

Level	Component	Base	Case	Pallet
M = mandatory C = conditional - = not used	-	C	C	-

T4291 Light bulb lamp type code

BMS ID	1486			
Definition	A code describing the type of light bulb, whether it is the trade item or is contained in the trade item.			

Example	The following values may be used in the Swedish market: Halogen LED			
Code value	Code value is specified according to code list T4291, see www.gs1.se/en-codelist-T4291 .			
Level	Component	Base	Case	Pallet
M = mandatory C = conditional - = not used	-	C	C	-

T4307 Light bulb base type

BMS ID	5463			
Definition	Free text field describing the type of base or socket associated with a light bulb.			
Example	E27 GU10			
Level	Component	Base	Case	Pallet
M = mandatory C = conditional - = not used	-	C	C	-

T4292 Colour temperature

BMS ID	5930			
Definition	Describes the light appearance provided by a light bulb.			
Example	2700 KEL			
Code value	Code value for measurement unit is specified according to code list T3781, see http://www.gs1.se/en-codelist-T3781 . For "T4292 Colour temperature" choose code value: KEL.			
Level	Component	Base	Case	Pallet
M = mandatory C = conditional - = not used	-	C	C	-

T4293 Light output

BMS ID	5461			
Definition	The amount of light a fixture produces and how the fixture emits and distributes that light, usually measured in lumens or lux.			
Example	450 LUX			
Code value	Code value for measurement unit is specified according to code list T3780, see http://www.gs1.se/en-codelist-T3780 . For "T4293 Light output" choose code value: B60 (Lumens) or LUX (Lux).			

Level	Component	Base	Case	Pallet
M = mandatory C = conditional - = not used	-	C	C	-

Colour

This group of attributes is used to describe the colour of the trade item. If the trade item has several colours the whole group of attributes is repeated for every colour.

Level	Component	Base	Case	Pallet
M = mandatory C = conditional - = not used	-	C	C	C

T2241 Colour code list code

BMS ID	6242			
Definition	Code indicating the parties controlling the colour code lists.			
Description	The colour code list agency is dependent on the colour code value. The attribute is required if "T2242 Colour code value" is used.			
Code value	Code value is specified according to code list T2241, see www.gs1.se/en-codelist-T2241 .			
Level	Component	Base	Case	Pallet
M = mandatory C = conditional - = not used	-	C	C	C

T2242 Colour code

BMS ID	3554			
Definition	Code indicating the colour of the trade item according to the current colour code list agency.			
Description	The current colour code list agency is specified in "T2241 Colour code list agency".			
Code value	Code values are supplied by the subject code list agency.			
Level	Component	Base	Case	Pallet
M = mandatory C = conditional - = not used	-	C	C	C

T2243 Colour description

BMS ID	3552			
Definition	Description in free text of the colour of the trade item.			

Description	To state a colour description without specifying a code value for colour, the following solution is recommended: "T2241 Colour code list agency": 7 (Means "Assigned by seller") "T2242 Colour code value": NO_CODE Always specify the information in Swedish.			
Note	Allows for the representation of the same value in different languages, but not for multiple values.			
Level	Component	Base	Case	Pallet
M = mandatory C = conditional - = not used	-	C	C	C

Trade item regulatory information

This group of attributes is used to specify information about trade item regulatory information.

Level	Component	Base	Case	Pallet
M = mandatory C = conditional - = not used	-	C	C	C

T3825 Regulation type code

BMS ID	3070			
Definition	The code indicating a type of regulation.			
Description	This attribute should be used together with "T4308 Is trade item regulation compliant".			
Example	FISH_AND_SEAFOOD_TRACEABILITY_REGULATION CONSUMER_PRODUCT_SAFETY FOOD_INFORMATION_REGULATION			
Code value	Code value is specified according to code list T3825, see www.gs1.se/en-codelist-T3825 .			
Level	Component	Base	Case	Pallet
M = mandatory C = conditional - = not used	-	C	C	C

T5039 Regulatory act

BMS ID	3071			
Definition	The name given to the requirement assigned by the regulatory agency			

Example	To refer to: <ul style="list-style-type: none"> The National Agency of Public Procurement’s procurement rules for: <ul style="list-style-type: none"> Vegetable fats: Information on origin- non-compound products, enter: 11010 (UHM) Coffee, tea and cocoa: EU-organic product, enter: 11009 (UHM) The EU control regulation on control of fishing and sales, enter: EC 1124/2009 The EU regulation concerning required labeling information for animal feed, enter: EG 767/2009 The EU regulation concerning the marketing and use of explosives precursors, enter EC 2019 1148 			
Level	Component	Base	Case	Pallet
M = mandatory C = conditional - = not used	-	C	C	C

T5040 Regulatory agency

BMS ID	3072			
Definition	The name of the specific entity in charge of issuing the permit to a company.			
Example	UHM Havs- och vattenmyndigheten			
Note	When the National Agency for Public Procurement is responsible for the requirement an abbreviation for the council is specified "UHM".			
Level	Component	Base	Case	Pallet
M = mandatory C = conditional - = not used	-	C	C	C

T4308 Is trade item regulation compliant

BMS ID	3074			
Definition	The indicator specifying whether the product is compliant, not compliant or not applicable to the regulation associated with the Regulation Type Code.			
Description	This attribute should be used together with "T3825 Regulation type code".			
Example	<p>If the product contains restricted explosive precursors, specify: "T3825 Regulation type code": EXPLOSIVES_PRECURSORS_REGISTRATION - Restricted explosive precursors "T4308 Is trade item regulation compliant": True</p> <p>If the product contains reportable explosive precursors, specify: "T3825 Regulation type code": EXPLOSIVES_PRECURSORS_REPORTING - Reportable explosive precursors "T4308 Is trade item regulation compliant": True</p>			
Code value	True – The product is compliant by the specified regulation type code False – The product is not compliant by the specified regulation type code			
Note	This attribute should also be used together with "T4309 Regulatory act compliance level code" when product contains restricted explosive precursor listed in Annex I of EU Regulation 2019/1148.			
Level	Component	Base	Case	Pallet

M = mandatory C = conditional - = not used	-	C	C	C
--	---	---	---	---

T4309 Regulatory act compliance level code

BMS ID	3075			
Definition	Code that compares the amount/level of the product or its composition with threshold amounts/levels defined by a regulation. This can vary for each regulation and market or region.			
Description	Always use this attribute when product contains restricted explosive precursor listed in Annex I of EU Regulation 2019/1148.			
Code value	Specify a code value according to code list " T4309 Regulatory act compliance level code compliant "			
Level	Component	Base	Case	Pallet
M = mandatory C = conditional - = not used	-	C	C	C

T5041 Regulatory permit identification

BMS ID	3087			
Definition	Identification of the permit or license given by the regulatory agency.			
Example	<p>For the procurement criteria from The National Agency for Public Procurement specify for example the certificate type leverantörsförsäkrän.</p> <p>For the EU Oval health mark, specify the approval number, for example", SV 1001 EG", "UK 1234 EC", "CZ 12345678 ES".</p>			
Level	Component	Base	Case	Pallet
M = mandatory C = conditional - = not used	-	C	C	C

T5042 Permit start date time

BMS ID	3086			
Definition	The start date and point of time on which the permit is effective.			
Description	<p>For the procurement criteria from National Agency for Public Procurement specify the date when the criterion is fulfilled.</p> <p>Times are expressed in UTC (Coordinated Universal Time), with a UTC designator ("Z").</p>			
Example	2017-07-08T12:00:00Z			
Level	Component	Base	Case	Pallet
M = mandatory C = conditional - = not used	-	C	C	C

Certification Information

Information on certification standards to which the trade item, or the process by which it is manufactured, sourced or supplied complies.

Level	Component	Base	Case	Pallet
M = mandatory C = conditional - = not used	-	C	C	-

T4497 Certification Standard

BMS ID	667			
Definition	The name of the certification standard or the type of certification, e.g. product, process, company, packaging or conformity.			
Level	Component	Base	Case	Pallet
M = Mandatory C - Conditional - = Not used	-	C	C	-

T4441 Certification agency

BMS ID	665			
Definition	Name of the organization issuing the certification standard or other requirement being met. Free text field.			
Level	Component	Base	Case	Pallet
M = Mandatory C = Conditional - = not used	-	C	C	-

T4433 Additional party identification type code

BMS ID	669			
Definition	Identification of a party by use of a code in addition to the Global Location Number.			
Description	Used together with <i>T4444 Additional certification organisation identifier</i> .			
Code value	Code value is specified according to code list: T4433 Additional party identification type code			
OBS!	This attribute is part of the ECHO data model; for further guidance and detailed information, see: Common ECHO data model .			
Level	Component	Base	Case	Pallet
M = Mandatory C = Conditional - = not used	-	C	C	-

T4444 Additional certification organisation identifier

BMS ID	668			
Definition	Additional identification of the organization that issued the certificate number confirming that the Trade Item has gone through certification.			
Description	Used together with <i>T4433 Additional party identification type code</i>			
OBS!	This attribute is part of the ECHO data model; for further guidance and detailed information, see: Common ECHO data model .			
Level	Component	Base	Case	Pallet
M = Mandatory C = Conditional - = not used	-	C	C	-

Certification

Information on certification to which the trade item complies.

Level	Component	Base	Case	Pallet
M = mandatory C = conditional - = not used	-	C	C	-

T4442 Certification value

BMS ID	685			
Definition	The unique identification (ID) that provides a trade item's certification standard value, official licensing number or identification which proves that a product/process has passed the certification procedure.			
Level	Component	Base	Case	Pallet
M = Mandatory C = Conditional - = not used	-	C	C	-

T4493 Subject Of Certification Description

BMS ID	7205			
Definition	The description that provides more information about the type of certification, e.g. the type of product, model, etc. as stated on the certificate.			
Definition	Indicate, for example, the product type or model as written in the certificate.			
Level	Component	Base	Case	Pallet
M = Mandatory C - Conditional - = Not used	-	C	C	-

T4494 Certificate Issuance Date Time

BMS ID	680			
Definition	The date and time that a certificate has been issued for a Trade Item.			
Description	Times are expressed in UTC (Coordinated Universal Time), with a UTC designator ("Z").			
Level	Component	Base	Case	Pallet
M = Mandatory C - Conditional - = Not used	-	C	C	-

T4496 Certification Effective Start Date Time

BMS ID	683			
Definition	The date and time upon which the certification is effective.			
Description	Times are expressed in UTC (Coordinated Universal Time), with a UTC designator ("Z").			
Level	Component	Base	Case	Pallet
M = Mandatory C - Conditional - = Not used	-	C	C	-

T4443 Certification effective end date time

BMS ID	682			
Definition	The date and time upon which the certification is no longer effective.			
Description	Times are expressed in UTC (Coordinated Universal Time), with a UTC designator ("Z").			
Example	2029-05-31T00:00:00Z			
Level	Component	Base	Case	Pallet
M = Mandatory C = Conditional - = not used	-	C	C	-

Safety data sheet information

Trade item information usually contained on a safety data sheet or on a material safety data sheet as it is referred to in some target markets.

Level	Component	Base	Case	Pallet
M = mandatory C = conditional - = not used	-	C	C	-

T4489 sDS Sheet effective date time

BMS ID	6287			
Definition	Date/time from which the content of the safety data sheet is valid. When issuing the data sheet for the first time, this date indicates the creation date. In case of updates, this date indicates the date of the last revision.			
Description	Times are expressed in UTC (Coordinated Universal Time), with a UTC designator ("Z").			
Level	Component	Base	Case	Pallet
M = Mandatory C - Conditional - = Not used	-	C	C	-

T4490 sDS sheet version



BMS ID	6286			
Definition	The safety data sheet version that uniquely identifies the release version of the safety data sheet. This version is needed to make data sheets versionable and revisions comprehensible.			
Level	Component	Base	Case	Pallet
M = Mandatory C - Conditional - = Not used	-	C	C	-







GHS details

This group of attributes is related to the Globally Harmonized System of Classification and Labelling of Chemicals.

Level	Component	Base	Case	Pallet
M = mandatory C = conditional - = not used	-	C	C	C

T3745 GHS Symbol description code

BMS ID	3238		
Definition	Code indicating the symbol that depicts health, physical and environmental hazard information according to GHS.		
Code value	Code value is specified according to code list T3745, see www.gs1.se/en-codelist-T3745 .		
Pictograms	Corrosion		
			
	Exclamation mark		

				
	Flame			
				
	Gas cylinder			
	Health hazard			
	Skull and crossbones			
	No pictogram		-	
Level	Component	Base	Case	Pallet
M = mandatory C = conditional - = not used	-	C	C	C

T5044 GHS signal words code

BMS ID	3237			
Definition	Code indicating the signal word according to GHS (The Globally Harmonized System of Classification and Labelling of Chemicals) for the item.			
Description	<p>Words such as "Danger" or "Warning" used to emphasize hazards and indicate the relative level of severity of the hazard.</p> <p>Read more about how the attribute is used in chapter Trade Item Information to comply with CLP regulation.</p>			
Code value	Code value is specified according to code list T5044, see www.gs1.se/en-codelist-T5044 .			
Level	Component	Base	Case	Pallet
M = mandatory C = conditional - = not used	-	C	C	C

Chemical ingredient

Chemical ingredient details for a specific chemical ingredient.

Level	Component	Base	Case	Pallet
M = mandatory C = conditional - = not used	-	C	C	-

T4503 Chemical Ingredient Scheme

BMS ID	3182			
Definition	A managed list of chemical ingredient identifications for example CAS.			
Level	Component	Base	Case	Pallet
M = Mandatory C - Conditional - = Not used	-	C	C	-

T4504 Chemical Ingredient Identification

BMS ID	3188			
Definition	A unique number to identify a chemical used to cross reference regulated lists of chemicals for example CAS number.			
Level	Component	Base	Case	Pallet
M = Mandatory C - Conditional - = Not used	-	C	C	-

T4488 REACH chemical registration number

BMS ID	3190			
Definition	A unique registration number for a chemical for a company. This is issued by the European Chemical Agency (ECHA) and is unique per chemical.			
Definition	The number is issued by the European Chemicals Agency (ECHA) and is unique for each chemical substance			
Level	Component	Base	Case	Pallet
M = Mandatory C - Conditional - = Not used	-	C	C	-

REACH information

Information on the trade item in relation to REACH legislation.

Level	Component	Base	Case	Pallet
M = mandatory C = conditional - = not used	-	C	C	-

T4462 Is substance of very high concern

BMS ID	3143			
Definition	An indicator that a trade item contains substances of very high concern (SVHC) according to REACH as defined in as defined in Article 57 of Regulation (EC) No 1907/2006. This indication does not mean the contained substance or substances have been added to the REACH Candidate List. Substances of very high concern (SVHC) are defined as: <ul style="list-style-type: none"> Substances that are category 1 and 2 carcinogens, mutagens or toxic to the reproductive system (CMR) Substances that are persistent, bio-accumulative and toxic (PBT) or very persistent and very bio-accumulative (vPvB) Substances such as endocrine disrupters, which are demonstrated to be of equivalent concern. For these substances, there are specific requirements under the REACH Regulation 			
Code value	true – substance of very high concern false – not a substance of very high concern			
Level	Component	Base	Case	Pallet
M = Mandatory C - Conditional - = Not used	-	C	C	-

T4463 Is trade item Reach relevant

BMS ID	3144			
Definition	An indicator that the trade item may have ingredients that subject it to REACH.			
Code value	true – ingredients that subject it to REACH false - no ingredients that subject it to REACH			
Level	Component	Base	Case	Pallet
M = Mandatory C - Conditional - = Not used	-	C	C	-

Hazard statement

Standard phrases describing the nature of a hazard per GHS. If the trade item has several hazard statements the whole group is repeated for every hazard statements.

Level	Component	Base	Case	Pallet
M = mandatory C = conditional - = not used	-	C	C	C

T5047 Hazard statements code

BMS ID	3240			
Definition	Standard phrases assigned to a hazard class and category that describe the nature of the hazard.			
Description	Read more about how the attribute is used in chapter Trade Item Information to comply with CLP regulation .			
Code value	Code value is specified according to the CLP regulation found on the Swedish Chemicals Agency, see www.kemi.se/en .			

Level	Component	Base	Case	Pallet
M = mandatory C = conditional - = not used	-	C	C	C

T5048 Hazard statements description

BMS ID	3241			
Definition	A description in free text of standard phrases assigned to a hazard class and category describing the nature of the hazard.			
Description	Always specify the information in Swedish. The text must be exactly as on the packaging. Read more about how the attribute is used in chapter Trade Item Information to comply with CLP regulation .			
Note	Allows for the representation of the same value in different languages, but not for multiple values.			
Level	Component	Base	Case	Pallet
M = mandatory C = conditional - = not used	-	C	C	C

Precautionary statement

Measures listed on a hazardous label to minimize or prevent adverse effects as per GHS. If the trade item has several precautionary statements the whole group is repeated for every precautionary statement.

Level	Component	Base	Case	Pallet
M = mandatory C = conditional - = not used	-	C	C	C

T5049 Precautionary statements code

BMS ID	3244			
Definition	Measures listed on a hazardous label to minimize or prevent adverse effects.			
Description	Read more about how the attribute is used in chapter Trade Item Information to comply with CLP regulation .			

Code value	Code value is specified according to the CLP regulation found on the Swedish Chemicals Agency, see www.kemi.se/en .			
Level	Component	Base	Case	Pallet
M = mandatory C = conditional - = not used	-	C	C	C

T5050 Precautionary statements description

BMS ID	3245			
Definition	A description in free text of the measures listed on a hazardous label to minimize or prevent adverse effects.			
Description	<p>The Precautionary statements description should be followed by the compound the precautionary statement refers to. The package should be marked with the compound adjacent to the precautionary statement package mark.</p> <p>Always specify the information in Swedish. The text must be exactly as on the packaging.</p> <p>Read more about how the attribute is used in chapter Trade Item Information to comply with CLP regulation.</p>			
Note	Allows for the representation of the same value in different languages, but not for multiple values.			
Level	Component	Base	Case	Pallet
M = mandatory C = conditional - = not used	-	C	C	C

Material

Details on the composition of any materials used to make a trade item.

Level	Component	Base	Case	Pallet
M = mandatory C = conditional - = not used	-	C	C	-

T4363 Trade item material designation description

BMS ID	3443			
Definition	The description of the element of place on the trade item, that the material information is being described. For example: filling, outer, eyes, trim.			
Level	Component	Base	Case	Pallet
M = mandatory C = conditional - = not used	-	C	C	-

T4379 Is designation intended for single use

BMS ID	8520			
Definition	Specifies whether the product or packaging is disposable and intended to only be used once before being thrown away or recycled.			
Description	The attribute can be used for trade items covered by the single-use plastics directive.			
Example	Disposable items can be, e.g. wipies or plastic cups.			
Level	Component	Base	Case	Pallet
M = mandatory C = conditional - = not used	-	C	C	-

T4391 Can materials be separated manually

BMS ID	8521			
Definition	The indicator that specifies whether the packaging materials can be separated manually without the help of tools.			
Level	Component	Base	Case	Pallet
M = mandatory C = conditional - = not used	-	C	C	-

T4380 Number of designation units

BMS ID	8522			
Definition	The number of designation units in the product that the material is associated to.			
Description	The attribute can be used for trade items covered by the single-use plastics directive.			
Example	For single use plastics cups, enter the amount of plastic cups.			
Note	The attribute refers to the trade item 's number of designation units. The packaging 's number of designation units per material is entered in "T4383 Number of packaging element units".			
Level	Component	Base	Case	Pallet
M = mandatory C = conditional - = not used	-	C	C	-

T4364 Material statement

BMS ID	6280			
Definition	Used to indicate the materials that are used in durable products. Material Statement is written as it is on the product or its label.			
Level	Component	Base	Case	Pallet

M = mandatory C = conditional - = not used	-	C	C	-
---	---	---	---	---

T4365 Material code

BMS ID	3454			
Definition	This element indicates the product material code that gives the composition of the trade item's first main material up to six material short codes that can be given in descending order of their respective percentages.			
Description	The attribute is mandatory if "T4367 Material percentage" is used. The attribute can be repeated if the trade item consists of several different materials.			
Code value	Code value is specified according to code list T4365 Material code .			
Level	Component	Base	Case	Pallet
M = mandatory C = conditional - = not used	-	C	C	-

T4366 Material content

BMS ID	3455			
Definition	This element is used to indicate the material composition.			
Level	Component	Base	Case	Pallet
M = mandatory C = conditional - = not used	-	C	C	-

T4367 Material percentage

BMS ID	3457			
Definition	Net weight percentage of a product material of the first main material. The percentages must add up to 100.			
Description	The attribute is mandatory if "T4365 Material code" is used. The attribute can be repeated if the trade item consists of several different materials.			
Level	Component	Base	Case	Pallet
M = mandatory C = conditional - = not used	-	C	C	-

T4368 Material thread count

BMS ID	3458			
Definition	This element is used to specify the quality of material (fabric) of a trade item.			
Level	Component	Base	Case	Pallet
M = mandatory C = conditional - = not used	-	C	C	-

T4369 Material weight

BMS ID	3460			
Definition	The measured weight of the material.			
Level	Component	Base	Case	Pallet
M = mandatory C = conditional - = not used	-	C	C	-

T4370 Thread denier

BMS ID	6565			
Definition	Denier is a measurement for fabric and threads. It is the mass in grams per 9,000 meters (9 kilometres) of the fibre/thread. The denier is based on a natural reference: a single strand of silk is approximately one denier; a 9000-meter strand of silk weighs about one gram (1 denier = 1 g / 9000 m).			
Level	Component	Base	Case	Pallet
M = mandatory C = conditional - = not used	-	C	C	-

T4402 Material density

BMS ID	8641			
Definition	The density of the material expressed as its mass per unit volume, e.g., kilograms per cubic metre or pounds per cubic foot.			
Code value	Code value for measurement unit is specified according to code list T3780 Measurement unit code .			
Note	The attribute refers to the density of the trade item's material. The density of the packaging material is specified in "T4404 Packaging material density".			
Level	Component	Base	Case	Pallet
M = mandatory C = conditional - = not used	-	C	C	-

T4382 Raw material code

BMS ID	8525
Definition	The code describing the type of raw or recycled material the product material is made from.
Description	The attribute is mandatory if "T4381 Raw material content percentage" is used.
Example	Recycled (RECYCLED)

Code value	Code value is specified according to code list T4382, see www.gs1.se/en-codelist-T4382 .			
Note	The attribute refers to the trade item´s material. The packaging´s material is entered in "T4285 Packaging raw material code".			
Level	Component	Base	Case	Pallet
M = mandatory C = conditional - = not used	-	C	C	-

T4381 Raw material content percentage

BMS ID	8524			
Definition	The percentage of the type of raw or recycled material the product material is made from, as specified by the Raw material code.			
Description	Used together with "T4382 Raw material code" to describe the percentage of a given raw material or recycled material that the trade item is made of. The attribute can be repeated if the trade item consists of several different raw materials. Enter a percentage between 1- and 100.			
Level	Component	Base	Case	Pallet
M = mandatory C = conditional - = not used	-	C	C	-

Package

This group is used to specify the type of packaging used, for example a bottle or box, whether the package is returnable, and deposit information for the package, if any.

Level	Component	Base	Case	Pallet
M = mandatory C = conditional - = not used	-	M	M	M

T0189 Packaging terms and conditions code

BMS ID	2177			
Definition	Code indicating whether the supplier has paid the appropriate fee for recycling of the packaging material.			
Description	The attribute is only used if the fee for packaging material is paid. Read more about how the attribute is used in the separate Guideline for Packaging Material . The trade items in a hierarchy have normally the same status, i.e. the fee is paid or not paid for every item in the hierarchy. An exception is item trade item hierarchies with returnable packages or unpacked trade items.			

Code value	Code value is specified according to code list T0189, see www.gs1.se/en-codelist-T0189 .			
Level	Component	Base	Case	Pallet
M = mandatory C = conditional - = not used	-	C	C	C

T0137 Packaging type code

BMS ID	2186			
Definition	Code indicating the type of package or container in which the goods are packed.			
Description	<p>Package type is important information for logistics. Many buyers use robots for automatic picking of goods. If an item cannot be picked automatically due to package type, the buyer must be informed about this in advance.</p> <p>Package type is also used for shelf planning. Certain package types, for example gable tops, are not possible to stack. Other package types, for example roll packs, need an edge to not roll off the shelf.</p> <p>Primarily, the attribute is used to enter the main packaging type. To specify the different packaging parts of the trade item, "T4354 Packaging material element code" is recommended.</p> <p>Read more about how the attribute is used in the separate Guideline for Packaging Material.</p>			
Code value	Code value is specified according to code list T0137, see www.gs1.se/en-codelist-T0137			
Level	Component	Base	Case	Pallet
M = mandatory C = conditional - = not used	-	M	M	M

T4492 Packaging type description

BMS ID	2187			
Definition	System generated text description of the type of packaging used for the trade item.			
Description	Used only when sending trade item information to Systembolaget Local code list used together with code value CNG in <i>T0137 Packaging type code</i>			
Code value	Code value is specified according to code list T4492 Packaging type description			
Level	Komponent	Bas	Mellan	Topp
M = mandatory C = conditional - = not used	-	C	C	-

T4124 Packaging function code

BMS ID	2167			
Definition	Code indicating specific packaging functions.			

Code value	Code value is specified according to code list T4124, see www.gs1.se/en-codelist-T4124 .			
Level	Component	Base	Case	Pallet
M = mandatory C = conditional - = not used	-	C	C	C

T4237 Packaging feature code

BMS ID	2166			
Definition	A packaging feature that facilitates the usage of the product by the consumer.			
Description	The code list aims to describe in more detail the characteristics of the package. Features do not affect the core composition of the packaging type nor modify its usage. The packaging feature does not affect the choice of packaging type in "T0137 Packaging type code".			
Code value	Code value is specified according to code list T4237, see www.gs1.se/en-codelist-t4237 .			
Level	Component	Base	Case	Pallet
M = mandatory C = conditional - = not used	-	C	C	C

T2244 Platform type code

BMS ID	2181			
Definition	Code indicating the type of dispatch unit being used for the trade item.			
Description	The attribute is used when the code value for "T0137 Packaging type code" is PX=Pallet or PB=Pallet Box.			
Code value	Code value is specified according to code list T2244, see www.gs1.se/en-codelist-T2244 .			
Level	Component	Base	Case	Pallet
M = mandatory C = conditional - = not used	-	C	C	C

T4454 Platform terms and conditions code

BMS ID	2180			
Definition	Indicates if the pallet in the prescribed pallet configuration is rented, exchangeable, against deposit or one way (not reusable).			
Code value	Code value is specified according to code list: T4454 Platform attributes and conditions code			
OBS!	This attribute is part of the ECHO data model; for further guidance and detailed information, see: Common ECHO data model .			
Level	Component	Base	Case	Pallet
M = Mandatory C = Conditional	-	C	C	-

- = not used				
--------------	--	--	--	--

T2207 Is trade item a display unit

BMS ID	151			
Definition	Code indicating whether the item is a display unit.			
Description	The attribute is only used if this trade item is a display unit. If the attribute is not used, then it means that the item is not a display unit.			
Code value	true - display unit false - not a display unit			
Level	Component	Base	Case	Pallet
M = mandatory C = conditional - = not used	-	-	C	C

T4372 Packaging sustainability feature code

BMS ID	2176			
Definition	A feature of the packaging that contributes to sustainability initiatives for example that it is made from renewable materials.			
Example	If the packaging is made from recycled material, the code MADE_FROM_RECYCLED_MATERIAL should be entered.			
Note	The attribute refers to the packaging characteristics specified in "T0137 Packaging type code". i.e the entire packaging and not the various constituent materials. Properties for individual materials are specified in "T4285 Packaging raw material code".			
Code value	Code value is specified according to code list T4372 Packaging sustainability feature code .			
Level	Component	Base	Case	Pallet
M = mandatory C = conditional - = not used	-	C	C	C

T0277 Is packaging marked returnable

BMS ID	2308			
Definition	Code indicating whether the packaging is returnable, that is, whether or not the package may be returned to be refilled.			
Description	Some returnable packages have a deposit. Some examples are returnable bottles, bread crates, roll cage for dairy products and euro pallet. Read more about how the attribute is used in the separate Guideline for Packaging Material .			
Code value	true - returnable packing false - not returnable packing			

Note	If the code value for "T0277 Is packaging marked returnable" = true, then "T0148 Returnable package deposit identification" must be specified.			
Level	Component	Base	Case	Pallet
M = mandatory C = conditional - = not used	-	C	C	C

Deposit and returnable assets

This group is only used if a deposit is charged for the trade item and if the code value for "T0277 Is packaging marked returnable" is "true" and the packaging can be returned for reuse or recycling.

Level	Component	Base	Case	Pallet
M = mandatory C = conditional - = not used	-	C	C	C

T3828 Returnable asset, GRAI

BMS ID	2277			
Definition	The GS1 Identification Key used to identify Returnable Assets. The key comprises a GS1 Company Prefix, Asset Type, Check Digit, and optional serial number.			
Description	GRAI (Global returnable Asset Identifier) is used to number individual return cargo carriers in the return system, such as plastic pallets and gas cylinders with unique identities. The identity can be linked to information about an individual unit and is especially suitable for load carriers with high demands for traceability, such as transport boxes of medicines			
Level	Component	Base	Case	Pallet
M = mandatory C = conditional - = not used	-	C	C	C

T0148 Returnable package deposit identification

BMS ID	2293			
Definition	Code indicating the type of deposit that is charged for the returnable or recyclable package.			
Description	<p>The deposit code can be used as an item identity for pallets or packages in dispatch advices and invoices.</p> <p>By sending a deposit code in item information the seller advises the buyer that "deposit" will be invoiced. This simplifies, for example, correlating the order with the invoice or the onward selling of the item.</p>			
Code value	Code value is specified according to code list T0148, see www.gs1.se/en-codelist-T0148 .			
Note!	<p>A code value should always be specified if "T0277 Is packaging marked returnable" = true.</p> <p>The code is also used for returnable pallets and packages that do not have a deposit.</p> <p>For beverages, the consumer units that are registered as deposit</p>			

	items at Pantamera should be specified in T0148.			
	The type of pallet is not permitted to be changed without assigning the trade item a new GTIN (Global Trade Item Number). Example, EUR-pallet is changed to SRS-pallet or vice versa.			
Level	Component	Base	Case	Pallet
M = mandatory C = conditional - = not used	-	C	C	C

T4125 Returnable assets contained quantity

BMS ID	2281			
Definition	The number of returnable assets that a trade items contains.			
Description	The attribute can be used when a trade item consists of more than one returnable asset on which a deposit is charged. The attribute is not needed to be used when a trade item consists of only one returnable asset on which a deposit is charged. If the number of returnable assets is not specified the number is assumed to be 1.			
Example	10 brims on a brewery pallet. Returnable assets contained quantity=10 (pieces)			
Code Value	Code value is specified according to code list T3780, see www.gs1.se/en-codelist-T3780 . For "T4125 Returnable assets contained quantity" choose code value: H87 – Piece			
Level	Component	Base	Case	Pallet
M = mandatory C = conditional - = not used	-	C	C	C

Packaging material

This group is used to provide information about packaging material. Producers are responsible for ensuring that packaging gets recycled and that associated fees are paid. Since fees vary based on packaging properties, it may be necessary to specify these.

If several materials are used, the type and weight are given for each.

Read more about how the attributes in this group are used in the separate [Guideline for Packaging Material](#).

Level	Component	Base	Case	Pallet
M = mandatory C = conditional - = not used	-	C	C	C

T1188 Packaging material type code

BMS ID	2206
Definition	Code indicating what the packaging material the package consists of.

Description	<p>Buyers may need to know packaging material type. Check with your buyer to determine what their requirements are.</p> <p>The attribute is mandatory if "T1189 Packaging material composition quantity" is used.</p> <p>If a trade item has several types of packaging material, packaging material can be supplied several times using this attribute.</p> <p>Please note that packaging materials do not need to be filled in when:</p> <ul style="list-style-type: none"> ■ The trade item does not have any packaging material, such as a baked potato ■ The trade item has returnable packaging which should therefore not be recycled <p>Read more about how the attribute is used in the separate Guideline for Packaging Material.</p>			
Code value	Code value is specified according to code list T1188 Packaging material type code .			
Level	Component	Base	Case	Pallet
M = mandatory C = conditional - = not used	-	C	C	C

T1189 Packaging material composition quantity

BMS ID	2214			
Definition	Weight of the specified packaging material per package and packaging material.			
Description	<p>The attribute is mandatory if "T1188 Packaging material type code" is used.</p> <p>Read more about how the attribute is used in the separate Guideline for Packaging Material.</p>			
Example	870			
Code Value	<p>Code value for measurement unit is specified according to code list "T3780 Measurement unit code". See www.gs1.se/en-codelist-T3780.</p> <p>For "T1189 Packaging material composition quantity" choose code value: GRM - gram</p>			
Level	Component	Base	Case	Pallet
M = mandatory C = conditional - = not used	-	C	C	C

T4374 Packaging material classification code reference

BMS ID	2220			
Definition	Identifies the packing material classification used in each packaging component.			
Description	Code indicating if the packaging material is flexible or rigid.			
Code value	Code value is specified according to code list T4374, see www.gs1.se/en-codelist-T4374 .			
Level	Component	Base	Case	Pallet

M = mandatory C = conditional - = not used	-	C	C	C
--	---	---	---	---

T4243 Packaging material colour code reference

BMS ID	2228			
Definition	Identifies the packaging material colour.			
Description	The colour of a packaging material may be relevant in connection with recycling, for example, since recycling costs vary depending on material colour. The attribute is applicable if the trade item is a consumer unit.			
Code value	Code value is specified according to code list T4243 Packaging material colour code reference .			
Level	Component	Base	Case	Pallet
M = mandatory C = conditional - = not used	-	C	C	C

T4354 Packaging material element code

BMS ID	7115			
Definition	The code that describes the part or element of the packaging of the product associated to a material or composite material.			
Description	<p>The code can be used to report individual parts of a package. The packaging part can then be reported together with its packaging material in, for example, sustainability follow-ups.</p> <p>The packaging material is reported in "T1188 Packaging material type code" and "T1189 Packaging material composition quantity".</p>			
Code Value	Code value is specified according to code list T4354 Packaging material code .			
Level	Component	Base	Case	Pallet
M = mandatory C = conditional - = not used	-	C	C	C

T4426 Is packaging element intended for food contact

BMS ID	8596			
Definition	The indicator that specifies if the packaging material element is intended to come into contact with food, directly or indirectly.			
Description	E.g., if any of the following is true: Intended to be brought into contact with food, Is already in contact with food, Can reasonably be expected to be brought into contact with food or to transfer their constituents to food under normal or foreseeable conditions of use.			
Level	Component	Base	Case	Pallet
M = mandatory C = conditional - = not used	-	C	C	-

T4355 Packaging material recycling scheme code

BMS ID	7117			
Definition	The code that specifies the recycling scheme the packaging of this trade item will fall within when recycled. Applies to recyclable packaging with or without deposit.			
Description	Code indicating the packaging recycling number, for example the EU Commission's identification system for packaging materials.			
Example	22 – Paper 70 – Colourless glass			
Code Value	Code value is specified according to code list T4355 Packaging material recycling scheme code .			
Level	Component	Base	Case	Pallet
M = mandatory C = conditional - = not used	-	C	C	C

T4371 Is packaging material recoverable

BMS ID	2207			
Definition	Determines whether packaging material is recoverable. Recoverable materials are those which are capable of being reused or returned to use in the form of raw materials.			
Level	Component	Base	Case	Pallet
M = mandatory C = conditional - = not used	-	C	C	C

T4283 Packaging labelling coverage percentage

BMS ID	6303			
Definition	Percentage of print/label and/or varnish coverage on the surface of the packaging.			
Description	The attribute is mandatory if "T4284 Packaging labelling type code" is used. Enter a percentage between 1 and 100. Read more about how the attribute is used in the separate Guideline for Packaging Material .			
Example	50			
Level	Component	Base	Case	Pallet
M = mandatory C = conditional - = not used	-	C	C	-

T4284 Packaging labelling type code

BMS ID	6304			
Definition	The type of text coverage of a packaging.			

Description	The attribute is mandatory if "T4283 Packaging labelling coverage percentage" is used. Read more about how the attribute is used in the separate Guideline for Packaging Material .			
Example	LABEL_ON_PACKAGING			
Code value	Code value is specified according to code list "T4284 Packaging labelling type code". See www.gs1.se/en-codelist-T4284 .			
Level	Component	Base	Case	Pallet
M = mandatory C = conditional - = not used	-	C	C	-

T4383 Number of packaging element units

BMS ID	8530			
Definition	The number of units of the associated material element contained in the package.			
Description	The attribute can be used when there is a need to know the number of packages inside, mainly used for products that have several products in packaging inside.			
Example	For a candy bag containing 20 pieces of chocolate wrapped in aluminium and plastic, the following is entered: T1188 Packaging material type code: METAL_ALUMINIUM T4383 Antal ingående förpackningsdelar per material: 20 T1188 Förpackningsmaterial: PLASTIC_OTHER T4383 Antal ingående förpackningsdelar per material: 20			
Note	The attribute refers to the packaging 's number of element units. The trade item 's number of element units is entered in "T4380 Number of designation units".			
Level	Component	Base	Case	Pallet
M = mandatory C = conditional - = not used	-	C	C	-

T4384 Packaging material adhesive amount

BMS ID	8531			
Definition	Adhesive amount refers to the total quantity of adhesive substance used to bond or join two or more surfaces together.			
Code value	Code value for measurement unit is specified according to code list "T3780 Measurement unit code" see www.gs1.se/en-codelist-T3780 .			
Level	Component	Base	Case	Pallet
M = mandatory C = conditional - = not used	-	C	C	-

T4385 Packaging material adhesive solubility type code

BMS ID	8534			
Definition	The code indicating how the adhesive can be dissolved or the adhesive strength of the adhesive is broken down.			
Example	Water soluble (WATER_SOLUBLE)			
Code value	Code value is specified according to code list T4385, see www.gs1.se/en-codelist-T4385 .			
Level	Component	Base	Case	Pallet
M = mandatory C = conditional - = not used	-	C	C	-

T4386 Packaging material adhesive type code

BMS ID	8536			
Definition	The code indicating the adhesive used in the packaging or packaging material of the product.			
Description	The information refers to glue that attaches materials or parts to the packaging, for example a glued label, and not glue that is used in the packaging material itself.			
Example	Hot-melt (HOT_MELT)			
Code value	Code value is specified according to code list T4386, see www.gs1.se/en-codelist-T4385 .			
Level	Component	Base	Case	Pallet
M = mandatory C = conditional - = not used	-	C	C	-

T4405 Packaging material applied process code

BMS ID	2209			
Definition	The processes applied to the material or used in the manufacturing of the material to modify/enhance its properties.			
Description	Used together with "T4403 Multilayer film material composition code" to specify the packaging material process.			
Example	LAMINATED_WITH_ADHESIVE – Laminerad med lim			
Code Value	Code value is specified according to code list T4405 Packaging material applied process code .			
Level	Component	Base	Case	Pallet
M = mandatory C = conditional - = not used	-	C	C	C

T4403 Multilayer film material composition code

BMS ID	8646			
Definition	The code that defines if the multilayered film can be considered as being composed of a mono or multi material, as determined by local regulations.			
Description	Used together with "T4405 Packaging material applied process code" to specify the relevant multilayer film composition.			
Example	MULTI_MATERIAL – Multi material			
Code value	Code value is specified according to code list T4403 Multilayer film material composition code .			
Level	Component	Base	Case	Pallet
M = mandatory C = conditional - = not used	-	C	C	-

T4404 Packaging material density

BMS ID	8648			
Definition	The density of the packaging material expressed as its mass per unit volume, e.g., kilograms per cubic metre or pounds per cubic foot.			
Example	0,92 gram per kubikcentimeter			
Code value	Code value for measurement unit is specified according to code list T3780 Measurement unit code .			
Note	The attribute refers to the density of the packaging material. The density of the trade item's material is specified in "T4402 Material density".			
Level	Component	Base	Case	Pallet
M = mandatory C = conditional - = not used	-	C	C	-

T4412 Additive name

BMS ID	8660			
Definition	The name of any additive or genetic modification contained or not contained in the trade item.			
Description	This attribute should be used together with "T4413 Level of containment code".			
Example	For a packaging material made of plastics and contains non-heat stable additives, specify: "T1188 Packaging material type code": PLASTIC_OTHER "T4412 Additive name": icke värmestabila additiv "T4413 Level of containment code": CONTAINS			
Level	Component	Base	Case	Pallet

M = mandatory C = conditional - = not used	-	C	C	-
--	---	---	---	---

T4413 Level of containment code

BMS ID	8661			
Definition	Code indicating the level of presence of the additive.			
Description	This attribute should be used together with "T4412 Additive name".			
Example	For a packaging material made of plastics and contains non-heat stable additives, specify: "T1188 Packaging material type code": PLASTIC_OTHER "T4412 Additive name": icke värmestabila additiv "T4413 Level of containment code": CONTAINS			
Code Value	Code value is specified according to code list T4413 Level of containment code .			
Level	Component	Base	Case	Pallet
M = mandatory C = conditional - = not used	-	C	C	-

T4285 Packaging raw material code

BMS ID	6306			
Definition	The code describing the type of raw or recycled material the product packaging material is made from.			
Description	The attribute is mandatory if "T4286 Packaging raw material content percentage" is used.			
Example	BIOLOGICAL_PLASTIC			
Code Value	Code value is specified according to code list T4285 Packaging raw material code .			
Level	Component	Base	Case	Pallet
M = mandatory C = conditional - = not used	-	C	C	-

T4286 Packaging raw material content percentage

BMS ID	6307			
Definition	The percentage of the type of raw or recycled material the product packaging material is made from.			

Description	Used together with "T4285 Packaging raw material code" to describe the percentage of a product packaging that consists of a given raw material. The attribute can be repeated if the packaging material consists of several different raw materials. Enter a percentage between 1 and 100.			
Example	60			
Note	The total percentage must add up to 100.			
Level	Component	Base	Case	Pallet
M = mandatory C = conditional - = not used	-	C	C	-

Composite material detail

Details on the materials that make up a composite material.

Read more about how the attributes in this group are used in the separate [Guideline for Packaging Material](#).

Level	Component	Base	Case	Pallet
M = mandatory C = conditional - = not used	-	C	C	C

T4394 Packaging material type code

BMS ID	2237			
Definition	The materials used for the packaging of the trade item for example glass or plastic. This material information can be used by data recipients for: <ul style="list-style-type: none"> o Tax calculations/fees/duties calculation o Carbon footprint calculations/estimations (resource optimisation) o to determine the material used. 			
Description	Buyers may need to know packaging material type. Check with your buyer to determine what their requirements are. The attribute is mandatory if "T4395 Packaging material composition quantity" is used. If a trade item has several types of composite packaging material, packaging material can be supplied several times using this attribute. Read more about how the attribute is used in the separate Guideline for Packaging Material .			
Code value	Code value is specified according to code list T4394 Packaging material type code .			
Level	Component	Base	Case	Pallet
M = mandatory C = conditional - = not used	-	C	C	C

T4395 Packaging material composition quantity

BMS ID	2238
---------------	------

Definition	The quantity of the packaging material of the trade item. Can be weight, volume or surface, can vary by country.			
Description	The attribute is mandatory if "T4394 Packaging material type code" is used. Read more about how the attribute is used in the separate Guideline for Packaging Material .			
Example	870			
Code Value	Code value for measurement unit is specified according to code list T3780 Measurement unit code . For T4395 Packaging material composition quantity choose code value: GRM - gram			
Level	Component	Base	Case	Pallet
M = mandatory C = conditional - = not used	-	C	C	C

T4396 Packaging material colour code reference

BMS ID	2250			
Definition	Identifies the packaging material colour.			
Description	The colour of a packaging material may be relevant in connection with recycling, for example, since recycling costs vary depending on material colour. The attribute is applicable if the trade item is a consumer unit.			
Code value	Code value is specified according to code list T4396 Packaging material colour code reference .			
Level	Component	Base	Case	Pallet
M = mandatory C = conditional - = not used	-	C	C	C

T4397 Packaging raw material code

BMS ID	6311			
Definition	The code describing the type of raw or recycled material the product packaging material is made from.			
Description	The attribute is mandatory if "T4398 Packaging raw material content percentage" is used.			
Example	BIOLOGICAL_PLASTIC			
Code Value	Code value is specified according to code list T4397 Packaging raw material code .			
Level	Component	Base	Case	Pallet
M = mandatory C = conditional - = not used	-	C	C	-

T4398 Packaging raw material content percentage

BMS ID	6312			
Definition	The percentage of the type of raw or recycled material the product packaging material is made from, as specified by the Packaging Raw Material Code.			
Description	Used together with "T4397 Packaging raw material code" to describe the percentage of a product packaging that consists of a given raw material. The attribute can be repeated if the packaging material consists of several different raw materials. Enter a percentage between 1 and 100.			
Example	60			
Note	The total percentage must add up to 100.			
Level	Component	Base	Case	Pallet
M = mandatory C = conditional - = not used	-	C	C	-

T4387 Packaging claim element code

BMS ID	8539			
Definition	The code that indicates an element in the product packaging that is subject to the claim specified by the Packaging claim type code.			
Description	Used together with "T4390 Packaging claim type code" to specify the relevant packaging manufacturing feature.			
Example	A package is partially made of recycled material. T4390 Packaging claim type code: Partially made with/from (PARTIALLY_MADE_WITH) T4387 Packaging claim element code: Recycled material (RECYCLED_MATERIAL)			
Code value	Code value is specified according to code list T4387, see www.gs1.se/en-codelist-T4387 .			
Level	Component	Base	Case	Pallet
M = mandatory C = conditional - = not used	-	C	C	-

T4388 Is packaging claim marked on package

BMS ID	8541
Definition	Is the claim specified by Packaging claim type code in combination with Packaging claim element code stated/claimed on the product package.

Description	The product package is labelled with claims specified in "T4390 Packaging claim type code" and "T4387 Packaging claim element code".			
Level	Component	Base	Case	Pallet
M = mandatory C = conditional - = not used	-	C	C	-

T4389 Is packaging claim regulated

BMS ID	8542			
Definition	Specifies whether the claim for the packaging is regulated.			
Description	The attribute can be used when "T4390 Packaging claim type code" and "T4387 Packaging claim element code" are filled in to indicate if the packaging claim is regulated.			
Level	Component	Base	Case	Pallet
M = mandatory C = conditional - = not used	-	C	C	-

T4390 Packaging claim type code

BMS ID	8543			
Definition	The code that states the type of claim relevant to the Packaging claim element code.			
Description	The degree to which a packaging is made with/from a specific code value stated in "T4387 Packaging claim element code".			
Example	<p>A package is partially made of recycled material.</p> <p>T4390 Packaging claim type code: Partially made with/from (PARTIALLY_MADE_WITH) T4387 Packaging claim element code: Recycled material (RECYCLED_MATERIAL)</p>			
Code value	Code value is specified according to code list T4390, see www.gs1.se/en-codelist-T4390 .			
Level	Component	Base	Case	Pallet
M = mandatory C = conditional - = not used	-	C	C	-

Dimensions

This group is used to specify various physical dimensions and weights of the trade item and declare price comparison measurement value for the trade item.

Level	Component	Base	Case	Pallet
-------	-----------	------	------	--------

M = mandatory C = conditional - = not used	-	M	M	M
---	---	---	---	---

T4017 Trade item measurements, width

BMS ID	3739			
Definition	The width of the trade item, as measured according to the GS1 Package and Product Measurement Standard. If the trade item is a unit load, include the shipping platform unless it is excluded according to the platformTypeCode chosen.			
Description	<p>Measurement value is specified in millimeter (mm).</p> <p>Trade item width is not permitted to be changed with more than 20% without assigning the trade item a new GTIN (Global Trade Item Number). Read more about GS1's GTIN rules at www.gs1.org/gtinrules.</p>			
Example	225			
Code Value	<p>Code value for measurement unit is specified according to code list "T3780 Measurement unit code", see www.gs1.se/en-codelist-T3780.</p> <p>For "T4017 Trade item measurements, width" choose code value: MMT – millimeter</p>			
Read more	See GS1 Package and Product Measurement Standard for the full set of rules regarding determination of trade item measurements.			
Level	Component	Base	Case	Pallet
M = mandatory C = conditional - = not used	-	M	M	M

T4019 Trade item measurements, height

BMS ID	3725			
Definition	The height of the trade item, as measured according to the GS1 Package and Product Measurement Standard. If the trade item is a unit load, include the shipping platform unless it is excluded according to the platformTypeCode chosen.			
Description	<p>Measurement value is specified in millimeter (mm).</p> <p>At a pallet level the Trade item height will include the height of the pallet itself.</p> <p>Trade item height is not permitted to be changed with more than 20 % without assigning the trade item a new GTIN (Global Trade Item Number). Read more about GS1's GTIN rules at www.gs1.org/gtinrules.</p>			
Example	150			
Code Value	<p>Code value for measurement unit is specified according to code list "T3780 Measurement unit code" see www.gs1.se/en-codelist-T3780.</p> <p>For "T4019 Trade item measurements, height" choose code value: MMT – millimeter</p>			

Read more	See GS1 Package and Product Measurement Standard for the full set of rules regarding determination of trade item measurements.			
Level	Component	Base	Case	Pallet
M = mandatory C = conditional - = not used	-	M	M	M

T4018 Trade item measurements, depth

BMS ID	3721			
Definition	The depth of the trade item, as measured according to the GS1 Package and Product Measurement Standard. If the trade item is a unit load, include the shipping platform unless it is excluded according to the platformTypeCode chosen.			
Description	<p>The measurement value is specified in millimeter (mm).</p> <p>Trade item depth is not permitted to be changed with more than 20 % without assigning the trade item a new GTIN (Global Trade Item Number). Read more about GS1's GTIN rules at www.gs1.org/gtinrules.</p>			
Example	330			
Code Value	<p>Code value for measurement unit is specified according to code list "T3780 Measurement unit code" see www.gs1.se/en-codelist-T3780.</p> <p>For "T4018 Trade item measurements, depth" choose code value: MMT – millimeter</p>			
Read more	See GS1 Package and Product Measurement Standard for the full set of rules regarding determination of trade item measurements.			
Level	Component	Base	Case	Pallet
M = mandatory C = conditional - = not used	-	M	M	M

T4362 Size type code

BMS ID	7230			
Definition	The type of size dimension for the size measurement or size description.			
Description	<p>Used together with "T4361 Size dimension" to specify the dimensions of a specific part of a trade item. It can be the capacity of a wine glass or the size of the cooking surface.</p> <p>The attribute is mandatory if "T4361 Size dimension" is used.</p> <p>Read more in the section Measurement guide for selected code values in T4362 Size type code</p>			
Code value	Code value is specified according to code list T4362 Size type code .			
Level	Component	Base	Case	Pallet

M = mandatory C = conditional - = not used	-	C	C	-
---	---	---	---	---

T4361 Size dimension

BMS ID	7222			
Definition	The numerical size measurement of the size dimension specified by the size type.			
Description	<p>Used together with "T4362 Size type code" to specify the dimensions of a specific part of a trade item. It can be the capacity of a wine glass or the size of the cooking surface.</p> <p>The attribute is mandatory if "T4362 Size type code" is used.</p>			
Example	200 mm, 20 cl			
Code value	<p>Code value for measurement unit is specified according to code list "T3780 Measurement unit code", see http://www.gs1.se/en-codelist-T3780.</p> <p>Choose a valid unit of measure based on the specified size type.</p>			
Level	Component	Base	Case	Pallet
M = mandatory C = conditional - = not used	-	C	C	-

T4020 Trade item gross weight

BMS ID	3777			
Definition	The gross weight of the item including all content and packaging material.			
Description	<p>In order to be able to plan transports, it is very important to know how much the trade items weigh because trucks have an upper limit for how heavy goods they can carry. The gross weight of the trade item includes all packaging material for the trade item. At the pallet level, the weight of the load carrier, usually the pallet, is also included in the gross weight.</p> <p>At pallet level the trade item gross weight includes the weight of the pallet itself.</p> <p>The gross weight is stated in grams.</p> <p>Trade item gross weight is not permitted to be changed with more than 20 % without assigning the trade item a new GTIN (Global Trade Item Number). Read more about GS1's GTIN rules at www.gs1.org/gtinrules</p>			
Example	265000			
Code Value	<p>Code value for measurement unit is specified according to code list "T3780 Measurement unit code" see www.gs1.se/en-codelist-T3780.</p> <p>For T4020 Trade item gross weight choose code value: GRM – gram</p>			
Level	Component	Base	Case	Pallet
M = mandatory C = conditional - = not used	-	C	C	C

T4330 Trade item net weight

BMS ID	3779			
Definition	The net weight of a trade item.			
Description	Used to identify the net weight of the trade item. Net weight excludes any packaging materials. Mainly used in the beauty industry.			
Example	10 Nail polish: Net content (T0082) 5 ml Net weight (T4330) 10 g			
Code Value	Code value for measurement is specified according to code list "T3780 Measurement unit code" see www.gs1.se/en-codelist-T3780 . For "T4330 Trade item net weight", use the code value GRM – gram			
Level	Component	Base	Case	Pallet
M = mandatory C = conditional - = not used	C	C	C	-

T0190 Packaging weight

BMS ID	2178			
Definition	Weight of the packaging material of the trade item.			
Description	<p>The packaging weight is stated in grams. Note that the weight of included items and packaging weight must not be included in the trade item packaging weight.</p> <p>For display units the total packaging weight shall be given, including any pallet. The weight of the included items and their packaging weight should not be included.</p> <p>The attribute is required for packages on case level unless the code value for "T0137 Packaging type code" is not "not packed".</p>			
Example	10500			
Code Value	Code value for measurement unit is specified according to code list "T3780 Measurement unit code" see www.gs1.se/en-codelist-T3780 . For "T0190 Packaging weight" choose code value: GRM – gram			
Level	Component	Base	Case	Pallet
M = mandatory C = conditional - = not used	-	-	C	C

T4201 Packaging height

BMS ID	2201			
Definition	The height of the packaging, as measured according to the GS1 Package and Product Measurement Standard . If the packaging dimensions are for a platform or pallet, the measurements for the platform or pallet itself are provided based on the orientation and tolerances for non-consumer trade items.			
Description	<p>Value is entered in this field unless the current platform height can be specified in another way. If the measurement refers to a load carrier or the height of the pallet, tolerances must be based on GS1 Package and Product Measurement Standard for non-consumer trade items.</p> <p>The attribute must be specified if the pallet platform height is not stated in either "T2244 Platform type code" and/or T0148. Returnable package deposit identification".</p>			
Code Value	<p>Code value for measurement unit is specified according to code list "T3780 Measurement unit code", see www.gs1.se/en-codelist-T3780.</p> <p>For "T4201 Packaging height" choose code value: MMT – millimeter</p>			
Level	Component	Base	Case	Pallet
M = Mandatory C = Conditional - = Not used	-	-	C	C

T3379 Layer height

BMS ID	3612			
Definition	The height of one layer of included items.			
Description	<p>The layer height should be the same as either the width or depth of the included item.</p> <p>The measurement value is specified in millimeter (mm).</p> <p>The attribute is only used for trade items on pallet level and if the layer height is not the same as the height of the included item. The height of the included item and the layer height may for example differ if the included item is not loaded in a standing position.</p> <p>If the layer height differs from the height of the included trade item due to nested stacking, then it should not be given here, but in "T3378 Nesting increment" for the included item.</p>			
Code Value	<p>Code value for measurement unit is specified according to code list "T3780 Measurement unit code", see www.gs1.se/en-codelist-T3780.</p> <p>For "T3379 Trade item layer height" choose code value: MMT – millimeter</p>			
Level	Component	Base	Case	Pallet
M = mandatory C = conditional - = not used	-	-	-	C

Net content

The net content can be repeated for an item if the supplier wants to specify the contents in several ways, for example both 800 grams and 75 pieces for a package of meatballs.

This group of attributes is mandatory if the trade item is a consumer unit.

Level	Component	Base	Case	Pallet
M = mandatory C = conditional - = not used	-	C	C	-

T0082 Net content

BMS ID	3733			
Definition	The amount of the trade item contained in the package.			
Description	<p>The attribute is used for specifying the net content in the package.</p> <p>Package contents is not permitted to be changed without assigning the trade item a new GTIN (Global Trade Item Number). Read more about GS1's GTIN rules at www.gs1.org/gtinrules.</p>			
Example	10.5			
Code Value	<p>Code value for measurement unit in which the net contents value is expressed is specified according to code list "T3780 Measurement unit code" see www.gs1.se/en-codelist-T3780.</p> <p>For "T0082 Net content" measurement unit choose one of the code values:</p> <p>GRM – gram</p> <p>MLT – milliliter (use for alcohol products)</p> <p>MMT – millimeter</p> <p>MTK – square meter</p> <p>MTQ – cubic meter</p> <p>H87 - piece</p>			
Note	<p>For food preserved in liquid, both total weight and drained weight must be entered.</p> <p>Specify the net weight including liquid in the following attribute: "T0082 Net content, value"</p> <p>To specify weight excluding liquid, so-called drained weight, use the following attributes together: "T0145 Price comparison content type code": DRAINED_WEIGHT – By drained weight "T0147 Price comparison measurement"</p>			
Level	Component	Base	Case	Pallet
M = mandatory C = conditional - = not used	C	C	C	-

T4305 Net content statement

BMS ID	3741			
Definition	The statement corresponding to the net content description.			
Description	The net content statement may appear on the product packaging but does not need to.			
Example	4 x 100 gr = 400 gr			
Note	Allows for the representation of the same value in different languages, but not for multiple values.			
Level	Component	Base	Case	Pallet
M = mandatory C = conditional - = not used	C	C	C	-

Trade item nesting

This group of attributes can be used to provide details on how trade items nest with one another, for measuring purposes. This group is used when the nesting increment is not equal to the trade item height, such as in the case of a bucket or returnable box.

Level	Component	Base	Case	Pallet
M = mandatory C = conditional - = not used	-	C	C	C

T3378 Nesting increment

BMS ID	3767
Definition	The additional height when stacking (i.e. the value by which the height increases for each package in the stack over one).
Description	<p>The nesting increment is the height by which a stack increases if an additional package is placed on the stack.</p> <p>Nesting increment is given for packages when it is not the same as the item's height and/or layer height.</p> <p>Examples: a pack of table margarine, returnable boxes, SRS boxes or buckets.</p> <p>The measurement value is specified in millimeters (mm).</p>

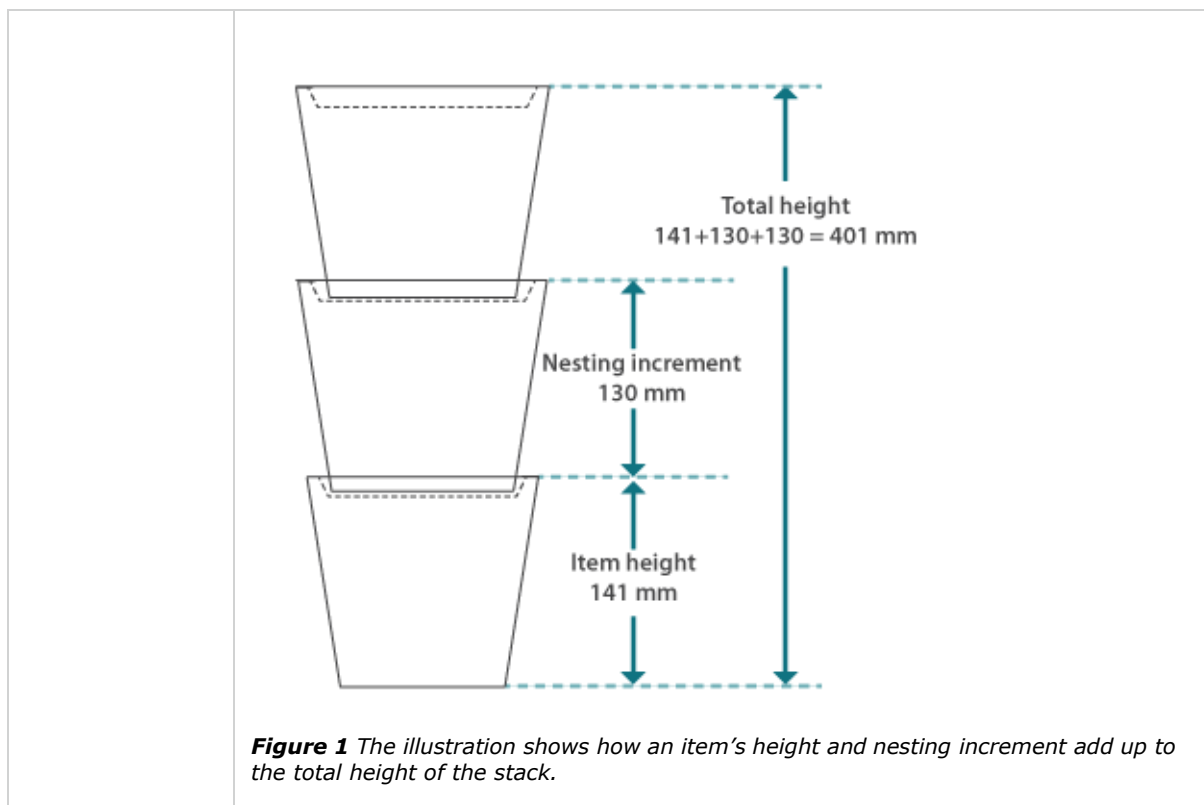
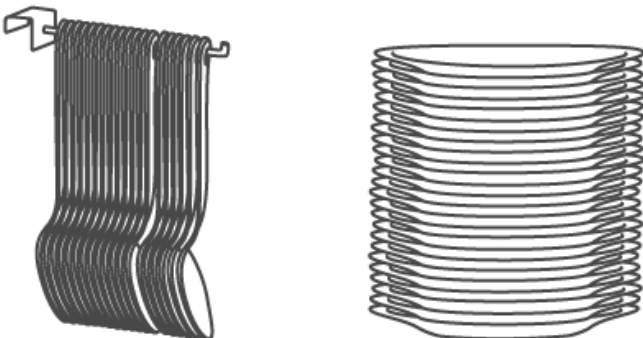

Figure 1 The illustration shows how an item's height and nesting increment add up to the total height of the stack.

Code Value	Code value for measurement unit is specified according to code list "T3780 Measurement unit code" see www.gs1.se/en-codelist-T3780 . For "T3378 Nesting increment" choose code value: MMT – millimeter			
Level	Component	Base	Case	Pallet
M = mandatory C = conditional - = not used	-	C	C	C

T2236 Nesting direction code

BMS ID	3769
Definition	Code indicating the arrangement of two items that nest together, that is, whether they nest against each other or on top of each other.
Code value	Code value is specified according to code list "T2236 Nesting direction code", see www.gs1.se/en-codelist-T2236 .

				
	Horizontal nesting direction	Vertical nesting direction		
<p>Figure 2 Horizontal nesting is a nesting arrangement where the items hang against each other, like spatulas on a long hanging peg. Vertical nesting is a nesting arrangement where the items stack on top of each other, like bowls.</p>				
Level	Component	Base	Case	Pallet
M = mandatory C = conditional - = not used	-	C	C	C

Additional dimensions

This group of attributes refer to the dimensions (depth, height, width) for a trade item in a variety of conditions (e.g. out of package, display item standing on shelf). Use the attribute "T3816 dimension type code" in combination with T3817, T3818 and T3819.

Level	Component	Base	Case	Pallet
M = mandatory C = conditional - = not used	-	C	C	-

T3816 Dimension type code

BMS ID	3761
Definition	Depicts certain measurement scenarios (e.g. out of package, Display Item Standing On Shelf) used for measurement.
Description	<p>Allowed dimension type codes on the Swedish market are:</p> <p>OUT_OF_PACKAGE – Out Of Package. Product is removed from consumer packaging, assembled if necessary for final use and its dimensions. For example: Computer desk; entertainment centre; microwave oven.</p> <p>DISPLAY_ITEM_STANDING_ON_SHELF– Display Item Standing On Shelf. Item has been assembled for display and it has been placed for display on the shelf. The dimension width of the item from side to side when displayed in store.</p> <p>The code value is only used for packages intended for display in store and when the measure for "T4017 Trade item measurements, width" differs from T3816 code "Display Item Standing On Shelf" + "T3817 Additional trade item dimensions, width".</p>

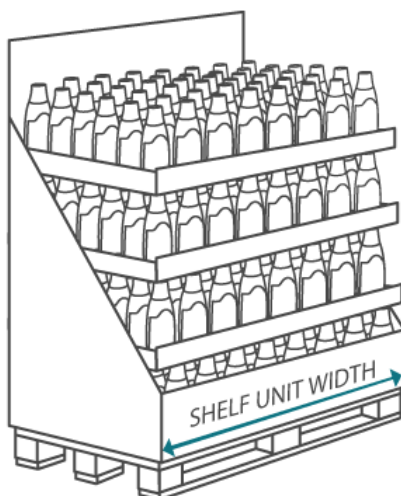

Figure 3 Code "Display Item Standing On Shelf" + "Dimension width" is the trade item width from side to side as exposed in the store.

Code value	Code value is specified according to code list "T3816 Dimension type code", see www.gs1.se/en-codelist-T3816 .			
Level	Component	Base	Case	Pallet
M = mandatory C = conditional - = not used	-	M	M	-

T3817 Additional trade item dimensions, width

BMS ID	3764			
Definition	The width of the trade item, as measured according to the GS1 Package and Product Measurement Standard . If the trade item is a unit load, include the shipping platform unless it is excluded according to the platformTypeCode chosen.			
Description	Measurement value is specified in millimeter (mm).			
Code Value	Code value for measurement unit is specified according to code list "T3780 Measurement unit code" see www.gs1.se/en-codelist-T3780 . For "T3817 Additional trade item dimensions", width choose code value: MMT – millimeter			
Level	Component	Base	Case	Pallet
M = mandatory C = conditional - = not used	-	M	M	-

T3818 Additional trade item dimensions, height

BMS ID	3762			
Definition	The height of the trade item, as measured according to the GS1 Package and Product Measurement Standard . If the trade item is a unit load, include the shipping platform unless it is excluded according to the platformTypeCode chosen.			
Description	Measurement value is specified in millimeter (mm).			

Code Value	Code value for measurement unit is specified according to code list "T3780 Measurement unit code" see www.gs1.se/en-codelist-T3780 . For "T3818 Additional trade item dimensions, height" choose code value: MMT – millimeter			
Level	Component	Base	Case	Pallet
M = mandatory C = conditional - = not used	-	M	M	-

T3819 Additional trade item dimensions, depth

BMS ID	3759			
Definition	The depth of the trade item, as measured according to the GS1 Package and Product Measurement Standard . If the trade item is a unit load, include the shipping platform unless it is excluded according to the platformTypeCode chosen.			
Description	Measurement value is specified in millimeter (mm).			
Code Value	Code value for measurement unit is specified according to code list "T3780 Measurement unit code" see www.gs1.se/en-codelist-T3780 . For "T3819 Additional trade item dimensions, depth" choose code value: MMT – millimeter			
Level	Component	Base	Case	Pallet
M = mandatory C = conditional - = not used	-	M	M	-

Storage and handling

This group of attributes can be used to specify how the item should be stored and handled.

Level	Component	Base	Case	Pallet
M = mandatory C = conditional - = not used	-	C	C	C

T0167 Minimum trade item lifespan from time of production

BMS ID	3704			
Definition	Time this trade item can be stored in the specified environment, i.e. the period from manufacture or packing to best-before date.			
Description	<p>The shelf life is stated in days and according to local rules and regulations.</p> <p>The attribute is mandatory for food and pharmaceutical consumer units, with some exceptions.</p> <p>For exceptions, for example bakery trade items with a 24h shelf life and no date on the packaging, this attribute should not be used. Instead, enter NO_DATE_MARKED in "T4032 Trade item date on packaging format type code".</p>			

Example	14			
Level	Component	Base	Case	Pallet
M = mandatory C = conditional - = not used	-	C	C	-

T0185 Minimum trade item lifespan from time of arrival

BMS ID	3703			
Definition	The period of days, guaranteed by the manufacturer, before the expiration date of the trade item, Based on arrival to a mutually agreed to point in the buyers distribution system. Can be repeatable upon use of GLN.			
Description	The number of days guaranteed by the manufacturer until the item's expiration date, counted from arrival at an agreed point in the buyer's distribution system.			
OBS!	This attribute is part of the ECHO data model; for further guidance and detailed information, see: Common ECHO data model .			
Level	Component	Base	Case	Pallet
M = Mandatory C = Conditional - = not used	-	C	C	-

T2521 Opened trade item lifespan

BMS ID	3705			
Definition	The number of days the trade item that had been opened can remain on the shelf and must then be removed.			
Description	<p>The attribute is used for trade items being divided and packaged. The information can amongst others be used to mark trade items, being divided and packaged in store, with expiry date.</p> <p>The lifespan is stated in number of days.</p> <p>Note that information intended for the consumer is not specified here but in "T3776 Consumer usage instructions".</p> <p>If the product carries an Open Jar symbol, use the attribute T4269 Item period safe to use after opening to enter the information.</p>			
Example	15			
Level	Component	Base	Case	Pallet
M = mandatory C = conditional - = not used	-	C	C	C

T4498 Average life

BMS ID	8746			
Definition	The period of time during which the trade item is expected to remain functional and perform its intended purpose before it needs replacement or major repairs,			

	e.g., for a light bulb with an average life of 1700 hours, a candle with an average life of 8 hours.			
Example	Light bulb with an average lifespan of 1700 hours. <ul style="list-style-type: none"> • T4498 Average life: 1700 • T4270 Time measurement unit code: HUR (Hour) 			
Code value	Code value for measurement unit is specified according to code list T4270 Time measurement unit code.			
Level	Component	Base	Case	Pallet
M = mandatory C = conditional - = not used	-	C	C	-

T4269 Item period safe to use after opening

BMS ID	3709			
Definition	The period after opening the product during which it is still safe to be used.			
Description	The attribute shall only be used when the product carries an Open Jar symbol. This may appear for example on soap, shampoo, cosmetics, etc.			
Example	6			
Code Value	Code value for measurement unit is specified according to code list "T4270 Time measurement unit code", see https://www.gs1.se/en-codelist-t4270 . For "T4269 Item period safe to use after opening" choose one of these code values: DAY - day MON - month ANN - year			
Level	Component	Base	Case	Pallet
M = mandatory C = conditional - = not used	-	C	C	C

T4242 Trade item temperature condition type code

BMS ID	3804			
Definition	The condition of the product sold to the end consumer.			
Description	The attribute is used when the status is indicated on the packaging. The attribute is mandatory if the trade item is a consumer unit which is deep frozen or has been previously frozen.			
Example	Kanelbulle tinad			
Code Value	<p>Code value is specified according to code list T4242, see www.gs1.se/en-codelist-T4242</p> <p>For previously frozen products, the following value shall be used in the Swedish market: THAWED – Previously frozen</p> <p>If the product is frozen the following value shall be used: DEEP_FROZEN – Deep frozen</p>			
Level	Component	Base	Case	Pallet
M = mandatory C = conditional - = not used	-	C	C	-

T3822 Temperature qualifier code

BMS ID	3830			
Definition	Code qualifying the type of a temperature requirement for example Storage and handling.			
Description	This attribute can be used together with “T3796 Maximum temperature” and “T3797 Minimum temperature”. These attribute together can be repeated depending on how many types of temperatures that are in demand.			
Code Value	Code value for is specified according to code list “T3846 Temperature qualifier code”, see www.gs1.se/en-codelist-T3846 .			
Level	Component	Base	Case	Pallet
M = mandatory C = conditional - = not used	-	M	M	M

T3796 Maximum temperature

BMS ID	3820			
Definition	The maximum temperature that a trade item can be held below defined by the manufacturer without affecting product safety or quality.			
Description	<p>This attribute can be used together with “T3822 Temperature qualifier code” and “T3797 Minimum temperature”. These attributes can be repeated depending on how many types of temperatures that are in demand.</p> <p>The attribute is used for temperature sensitive products. The temperature must be specified in degrees Celsius. It is recommended that the temperature is not specified with a greater accuracy than whole degrees.</p>			
Example	25			

Code Value	Code value for T3796 and temperature measurement unit is specified according to code list "T3781 Temperature measurement unit code", see www.gs1.se/en-codelist-T3781 . For "T3796 Maximum temperature" unit choose code value: CEL — Celsius			
Level	Component	Base	Case	Pallet
M = mandatory C = conditional - = not used	-	C	C	C

T3797 Minimum temperature

BMS ID	3826			
Definition	The minimum temperature that a trade item can be held below defined by the manufacturer without affecting product safety or quality.			
Description	This attribute can be used together with "T3822 Temperature qualifier code" and "T3796 Maximum temperature". These attributes together can be repeated depending on how many types of temperatures that are in demand. The attribute is used for temperature sensitive products. The temperature must be specified in degrees Celsius. It is recommended that the temperature is not specified with a greater accuracy than whole degrees.			
Example	12			
Code Value	The code value for T3797 and temperature measurement unit is specified according to code list "T3781 Temperature measurement unit code", see www.gs1.se/en-codelist-T3781 . For "T3797 Minimum temperature" unit choose code value: CEL — Celsius.			
Level	Component	Base	Case	Pallet
M = mandatory C = conditional - = not used	-	C	C	C

T4439 Cumulative temperature interruption acceptable time span instructions

BMS ID	3816			
Definition	Instructions provided by the product manufacturer regarding the process, procedures, or handling instructions for trade items that has exceeded the cumulative time span of temperature interruptions.			
Description	Can only be provided as a complement to temperature information specified using <i>T3822 Temperature qualifier code</i> , <i>T3797 Minimum temperature</i> and/or <i>T3796 Maximum temperature</i> .			
OBS!	This attribute is part of the ECHO data model; for further guidance and detailed information, see: Common ECHO data model .			
Level	Component	Base	Case	Pallet
M = Mandatory C = Conditional - = not used	-	C	C	C

T4459 Minimum process temperature timespan

BMS ID	8599			
Definition	The minimum amount of time that the product is required to be processed, relative to the process and temperature information provided by the manufacturer, to ensure product safety or quality.			
Description	<p>Shall be provided when <i>T4431 Initial sterilisation prior to use code</i> has the value AUTOCLAVE or DRY_HEAT .</p> <p>Used together with <i>T3822 Temperature qualifier code</i> with the value STERILISATION , <i>T3797 Minimum temperature</i> and <i>T3796 Maximum temperature</i>.</p>			
OBS!	This attribute is part of the ECHO data model; for further guidance and detailed information, see: Common ECHO data model .			
Level	Component	Base	Case	Pallet
M = Mandatory C = Conditional - = not used	-	C	C	C

T4460 Maximum process temperature timespan

BMS ID	8602			
Definition	The maximum amount of time that the product can safely be processed, relative to the process and temperature information provided by the manufacturer, without affecting product safety or quality.			
Description	<p>Shall be provided when <i>T4431 Initial sterilisation prior to use code</i> has the value AUTOCLAVE or DRY_HEAT .</p> <p>Used together with <i>T3822 Temperature qualifier code</i> with the value STERILISATION , <i>T3797 Minimum temperature</i> and <i>T3796 Maximum temperature</i>.</p>			
OBS!	This attribute is part of the ECHO data model; for further guidance and detailed information, see: Common ECHO data model .			
Level	Component	Base	Case	Pallet
M = Mandatory C = Conditional - = not used	-	C	C	C-

T4040 Handling instructions code reference

BMS ID	3587
Definition	Defines the information and processes needed to safely handle the trade item.

Example	<p>Enter handling information related to storage/transport, for example "The product can be frozen under certain conditions" – code value "FCC" if the trade item is freeze-resistant.</p> <p>When the trade item is a pharmaceutical that requires an unbroken cold chain during transport and storage of the product, choose code value "OTC" (Temperature Control).</p> <p>Code value "OTC" (Temperature Control) is only used for pharmaceuticals and has no connection to whether the product is sold over the counter or not.</p> <p>An unbroken cold chain means that the item may not, even for a short period of time, be stored in a temperature outside the given interval.</p> <p>If you use OTC you must provide the temperature interval that applies. See "T3822 Temperature qualifier code" for instructions on providing a temperature interval.</p>			
Code Value	<p>The code value is specified according to code list "T4040 Handling instructions code reference" see www.gs1.se/en-codelist-T4040.</p>			
Level	Component	Base	Case	Pallet
M = mandatory C = conditional - = not used	-	C	C	-

T4446 Required education or training type code

BMS ID	7110			
Definition	The code that describes the appropriate type of education or training required to use/handle/operate the product.			
Description	The information shall be provided when the Instructions for Use (IFU) specify that training or education is required for the user to handle the product.			
Code value	Code value is specified according to code list: T4446 Required education or training type code			
OBS!	This attribute is part of the ECHO data model; for further guidance and detailed information, see: Common ECHO data model .			
Level	Component	Base	Case	Pallet
M = Mandatory C = Conditional - = not used	-	C	C	-

T3847 Humidity qualifier code

BMS ID	3640			
Definition	Code qualifying the type of a humidity for example STORAGE.			
Description	<p>The attribute is only used for humidity-sensitive goods.</p> <p>This attribute can be used together with "T0166 Maximum humidity" and "T0165 Minimum humidity". These attributes together can be repeated depending on how many types of humidity that are in demand.</p> <p>The humidity type used on the Swedish market is:</p> <p>Storage and Handling</p>			
Code Value	Code value for is specified according to code list "T3846 Temperature qualifier code", see www.gs1.se/en-codelist-T3846 .			

Level	Component	Base	Case	Pallet
M = mandatory C = conditional - = not used	-	M	M	M

T0166 Maximum humidity percentage

BMS ID	3643			
Definition	Highest relative humidity percentage at which this product may be stored.			
Description	<p>The attribute is only used for humidity-sensitive goods.</p> <p>This attribute can be used together with "T3847 Humidity qualifier code" and "T0165 Minimum humidity percentage". These attribute together can be repeated depending on how many types of temperatures that are in demand.</p>			
Example	72 % is stated as 72			
Level	Component	Base	Case	Pallet
M = mandatory C = conditional - = not used	-	C	C	C

T0165 Minimum humidity percentage

BMS ID	3644			
Definition	Lowest relative humidity percentage at which this product may be stored			
Description	<p>The attribute is only used for humidity-sensitive goods.</p> <p>This attribute must be used together with "T3847 Humidity qualifier code" and "T0166 Maximum humidity percentage". These attribute together can be repeated depending on how many types of humidity that are in demand.</p>			
Example	68 % is stated as 68			
Level	Component	Base	Case	Pallet
M = mandatory C = conditional - = not used	-	C	C	C

T0191 Trade item composition width

BMS ID	3737			
Definition	Number of base level items packed beside each other in the trade item.			
Description	<p>Some outer packages can be placed on the shelf without the consumer units being unpacked. The information is used during shelf planning.</p> <p>The number is stated in pieces.</p>			
Example	15			

Code Value	Code value for measurement unit is specified according to code list "T3780 Measurement unit code", see www.gs1.se/en-codelist-T3780 . For "T0191 Trade item composition width" choose code value: H87 – piece			
Level	Component	Base	Case	Pallet
M = mandatory C = conditional - = not used	-	-	C	-

T4021 Quantity of complete layers contained in a trade item

BMS ID	3614			
Definition	The number of layers of the child trade item found in a trade item			
Description	The attribute is only used when the item is a pallet and is then used for specifying the number of package layers on the pallet. The attribute is not used on base or case level. The quantity is stated in pieces.			
Example	6			
Level	Component	Base	Case	Pallet
M = mandatory C = conditional - = not used	-	-	-	C

T0160 Quantity of trade items contained in a complete layer

BMS ID	3618			
Definition	Number of packages in each layer in the trade item.			
Description	If the quantity is different for different layers, then the quantity of the lowest layer should be specified.			
Example	24			
Level	Component	Base	Case	Pallet
M = mandatory C = conditional - = not used	-	-	-	C

T2239 Is trade item packed irregularly

BMS ID	3611			
Definition	Code indicating whether or not the item is packed in a non-rectilinear pattern.			
Description	An irregular packing pattern means that "T0160 Quantity of trade items contained in a complete layer" multiplied with "T4021 Quantity of complete			

layers contained in a trade item” is not equivalent to the quantity in “T4035 Total quantity of next lower level trade item”.

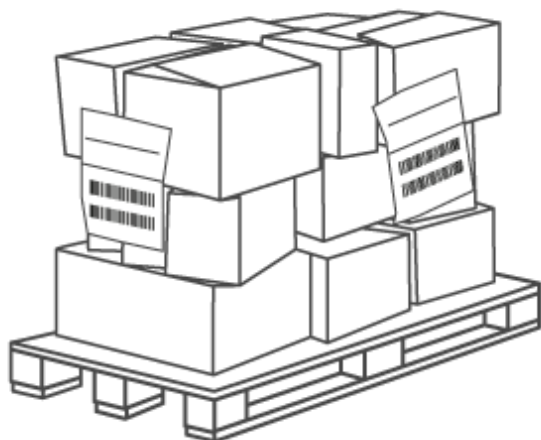

Figure 4 Irregularly packed pallet.

Code value	true - trade item is packed irregularly false - trade item is packed regularly			
Level	Component	Base	Case	Pallet
M = mandatory C = conditional - = not used	-	-	C	C

T0157 Stacking factor

BMS ID	3604			
Definition	Maximum number of items that can be stacked without damaging the goods.			
Description	<p>Some items can be damaged if they are stacked with heavy items on top of them. It is therefore essential to know how sensitive an item is to be crushed in order to plan how the packages should be transported or placed on the store shelf.</p> <p>The attribute is used for specifying the maximum number of trade item packages that can be stacked without damaging the goods.</p> <p>The stacking factor should be specified for the current trade item level.</p>			
Example	<p>If a maximum of 3 items can be stacked on one another, the stacking factor is 3.</p> <p>If no further pallets may be stacked on a pallet, the stacking factor is 1.</p>			
Level	Component	Base	Case	Pallet
M = mandatory C = conditional - = not used	-	C	C	M

T3848 Stacking factor type code

BMS ID	3607			
Definition	Indicates the supply chain process that the particular product may be stacked in.			

Description	<p>From a supply chain perspective, these values can differ from a storage perspective, truck transport, rail, etc.</p> <p>For example, a transportation by road can only be stack 2 pallets high, but in a warehouse that can be 3 pallets.</p> <p>Use this attribute in combination with "T0157 Stacking factor". This combination is repeatable depending where in the supply chain the trade item should be handled.</p>			
Code Value	Code value for is specified according to code list "T3848 Stacking factor type code" see www.gs1.se/en-codelist-T3848 .			
Level	Component	Base	Case	Pallet
M = mandatory C = conditional - = not used	-	C	C	M

Dangerous goods

This group of attributes is used to specify characteristics for item classed as dangerous goods. More information concerning dangerous goods can be found on the Swedish Civil Contingencies Agency website, www.mcf.se.

For guidance and examples of how to use these attributes to meet MCF guidelines, see **Trade Item Information to comply with MCF guidelines on dangerous goods**.

Level	Component	Base	Case	Pallet
M = mandatory C = conditional - = not used	-	C	C	C

T0263 Class of dangerous goods code

BMS ID	3879			
Definition	The dangerous goods classification of the trade item.			
Description	<p>Dangerous classes explain in general terms the hazardous nature and properties of the goods and serve to classify them together in terms of their most significant risk. There are nine classes, some with sub-classes. The code indicates the type of risk for the product. The most significant risk should be indicated.</p>			
Code value	<p>Code value is specified according to code list T0263, see www.gs1.se/en-codelist-T0263.</p> <p>Code list T0263 is a restricted code list managed by GS1 Sweden. For a full code list see external code list at www.mcf.se.</p>			
Level	Component	Base	Case	Pallet
M = mandatory C = conditional - = not used	-	C	C	C

T3743 Dangerous goods classification code

BMS ID	3880			
---------------	------	--	--	--

Definition	Code indicating the classification of the dangerous goods for transport by road and rail according to for example ADR/RID.			
Code value	T3743 refers to an external code list, see www.mcf.se .			
Level	Component	Base	Case	Pallet
M = mandatory C = conditional - = not used	-	C	C	C

T4022 Dangerous goods regulation code

BMS ID	3865			
Definition	An indication of the classification system(s) of dangerous goods and/or the Agency(ies) responsible for it.			
Description	The attribute is used together with <i>T4025 Dangerous goods hazardous code</i> and <i>T0169 United Nations dangerous goods number</i> .			
Code value	Code value is specified according to code list: T4022 Dangerous goods regulation code			
OBS!	This attribute is part of the ECHO data model; for further guidance and detailed information, see: Common ECHO data model .			
Level	Component	Base	Case	Pallet
M = Mandatory C = Conditional - = not used	-	C	C	C

T4025 Dangerous goods hazardous code

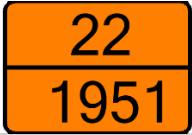
BMS ID	3881			
Definition	Dangerous goods hazard ID number, which must be applied to the vehicle, when transporting this trade item (dangerous good) by road or rail, to inform the police, the fire brigade and others in case of an accident about the kind of danger caused by the cargo.			
Description	Number to be applied in the upper part of the orange-coloured sign according to the regulations in ADR-S and RID-S. Used together with <i>T0169 United Nations dangerous goods number</i> and <i>T4022 Dangerous goods regulation code</i> . <div style="text-align: center; margin: 10px 0;">  </div>			
Code value	Code value is specified according to extern code list, www.mcf.se			
OBS!	This attribute is part of the ECHO data model; for further guidance and detailed information, see: Common ECHO data model .			
Level	Component	Base	Case	Pallet
M = Mandatory C = Conditional - = not used	-	C	C	C

T0264 Dangerous goods packing group

BMS ID	3882			
Definition	Code indicating level of danger, that is, how dangerous a substance or an object is considered to be.			
Description	I – Very dangerous substances – group I II – Dangerous substances – group II III – Substances with a low level of danger – group III			
Code Value	T0264 refers to an external code list, see www.mcf.se .			
Level	Component	Base	Case	Pallet
M = mandatory C = conditional - = not used	-	C	C	C

T4023 Flash point temperature

BMS ID	3866			
Definition	The lowest temperature at which a substance gives off a sufficient vapor to support combustion.			
Example	12			
Code Value	Code value for measurement unit is specified according to code list "T3781 Temperature measurement unit code", see www.gs1.se/en-codelist-T3781 . For "T4023 Flash point temperature" choose code value: CEL – Celsius			
Level	Component	Base	Case	Pallet
M = mandatory C = conditional - = not used	-	C	C	C

T4303 Net mass of explosives

BMS ID	3892			
Definition	The measurement of the net explosive mass of the trade item (dangerous goods) for transport by road and rail according to a dangerous goods classification regulation.			
Description	The attribute is used to state the weight of a dangerous good in grams or milliliters when net content for the dangerous good has been stated in "pieces" in T0082 Net content.			
Code Value	Code value for measurement unit is specified according to code list "T3780 Measurement unit code", see www.gs1.se/en-codelist-T3780 . For "T4303 Net mass of explosives" choose code value: GRM – gram MLT– milliliter			
Level	Component	Base	Case	Pallet
M = mandatory C = conditional - = not used	-	C	C	C

T0169 United Nations dangerous goods number

BMS ID	3894			
Definition	UN code for this product from the ADR code list (Accord Europeen relative au transport international des marchandises).			
Description	The attribute is used when the product is classified as dangerous.			
Code value	T0169 refers to an external code list, see www.mcf.se .			
Level	Component	Base	Case	Pallet
M = mandatory C = conditional - = not used	-	C	C	C

T4026 Dangerous goods shipping name

BMS ID	3883			
Definition	Shipping name of the trade item (dangerous goods).			
Description	The attribute is used for describing the recognized agencies (see dangerousGoodsRegulationsCodes), in their regulations, provide a list of all acceptable proper shipping names.			
Level	Component	Base	Case	Pallet
M = mandatory C = conditional - = not used	-	C	C	C

T4027 Dangerous goods technical name

BMS ID	3885			
Definition	Provides the dangerous goods technical information.			
Note	Allows for the representation of the same value in different languages, but not for multiple values. Always specify the information in Swedish.			
Level	Component	Base	Case	Pallet
M = mandatory C = conditional - = not used	-	C	C	C

T4247 Dangerous goods limited quantities code

BMS ID	6061			
Definition	A code defined by an agency specifying whether a dangerous good can be packaged in small quantities providing they are packaged and labelled in accordance with certain requirements.			

Code Value	Code value for is specified according to code list "T4247 Dangerous goods limited quantities code" see www.gs1.se/en-codelist-T4247 .			
Level	Component	Base	Case	Pallet
M = mandatory C = conditional - = not used	-	C	C	C

T4141 Hazardous material additional information

BMS ID	3868			
Definition	Any regulatory information required that is not specifically identified by another field.			
Note	Allows for the representation of the same value in different languages, but not for multiple values. Always specify the information in Swedish.			
Level	Component	Base	Case	Pallet
M = mandatory C = conditional - = not used	-	C	C	C

T4142 Dangerous goods special provisions

BMS ID	3884			
Definition	Code indicating the special regulations to be met regarding a Dangerous Goods Classification Regulation.			
Code Value	T4142 refers to an external code list, see www.mcf.se .			
Level	Component	Base	Case	Pallet
M = mandatory C = conditional - = not used	-	C	C	C

T3741 ADR tunnel restriction code

BMS ID	3863			
Definition	Code indicating the road tunnel restriction for the trade item according to ADR.			
Code value	T3741 refers to an external code list, see www.mcf.se .			
Level	Component	Base	Case	Pallet
M = mandatory C = conditional - = not used	-	C	C	C

T3744 Transport category code

BMS ID	3887			
---------------	------	--	--	--

Definition	Code indicating the transport category of the trade item according to ADR.			
Description	Transport categories are used to calculate the quantity of dangerous goods allowed to be transported on the same transport unit under specific exemption rules.			
Code Value	Code value is specified according to code list T3744 Transport category code .			
Level	Component	Base	Case	Pallet
M = mandatory C = conditional - = not used	-	C	C	C

Dangerous goods hazard label

This group of attributes is used to specify information about dangerous goods hazard labels, if any. A Dangerous goods hazard label is a visible label on the packaging indicating specific risks and required precautions associated with the dangerous good.

For guidance and examples of how to use these attributes to meet MCF guidelines, see **Trade Item Information to comply with MCF guidelines on dangerous goods.**

Level	Component	Base	Case	Pallet
M = mandatory C = conditional - = not used	-	C	C	C

T4143 Dangerous goods hazard label number

BMS ID	3896			
Definition	A visible number indicating the specific risk and thus the required precautions associated with a dangerous goods.			
Note	In the case of dangerous goods in limited quantities, the number does not have to be visible on the package. In these cases, use the number found in the Safety Data Sheet as the information is important to your recipient.			
Level	Component	Base	Case	Pallet
M = mandatory C = conditional - = not used	-	C	C	C

T4751 Dangerous hazardous label sequence number

BMS ID	3897			
Definition	A sequence number indicating the primacy of one dangerous goods label number over another.			
Example	For example, a value of 1 would indicate that the associated hazard label number is the primary, 2 = secondary, etc.			
Level	Component	Base	Case	Pallet
M = mandatory C = conditional - = not used	-	C	C	C

Cleaning disinfecting information

A group of attributes to help the buyer understand the cleaning and/or disinfecting of a product.

Level	Component	Base	Case	Pallet
M = mandatory C = conditional - = not used	-	C	-	-

T4447 Pre-cleaning indicator

BMS ID	7103			
Definition	The indicator that specifies whether pre-cleaning of the product is required before cleaning and disinfection.			
Description	Used together with <i>T4449 Product cleaning type code</i> and <i>T4448 Cleaning disinfection process code</i>			
Code value	true – pre-cleaning is required false – pre-cleaning is not required			
OBS!	This attribute is part of the ECHO data model; for further guidance and detailed information, see: Common ECHO data model .			
Level	Component	Base	Case	Pallet
M = Mandatory C = Conditional - = not used	-	C	-	-

T4448 Cleaning disinfection process code

BMS ID	7106			
Definition	The code that describes the type of process necessary to clean or disinfect the specific product.			
Description	Used together with <i>T4449 Product cleaning type code</i> or <i>T4450 Product disinfection type code</i> .			
Code value	Code value is specified according to code list: T4448 Cleaning disinfection process code			
OBS!	This attribute is part of the ECHO data model; for further guidance and detailed information, see: Common ECHO data model .			
Level	Component	Base	Case	Pallet
M = Mandatory C = Conditional - = not used	-	C	-	-

T4449 Product cleaning type code

BMS ID	7104			
Definition	The code that describes the form of cleaning/detergent that can be used for the product. Example: Cleaning/detergent in accordance with ISO 15883.			
Description	Used together with <i>T4448 Cleaning disinfection process code</i> .			
Code value	Code value is specified according to code list: T4449 Product cleaning type code			
OBS!	This attribute is part of the ECHO data model; for further guidance and detailed information, see: Common ECHO data model .			
Level	Component	Base	Case	Pallet
M = Mandatory C = Conditional - = not used	-	C	-	-

T4450 Product disinfection type code

BMS ID	7108			
Definition	The code that describes the type of disinfection that is possible for the product. Example: Disinfection type in accordance with ISO 15883.			
Description	Used together with <i>T4448 Cleaning disinfection process code</i>			
Code value	Code value is specified according to code list: T4450 Product disinfection type code			
OBS!	This attribute is part of the ECHO data model; for further guidance and detailed information, see: Common ECHO data model .			
Level	Component	Base	Case	Pallet
M = Mandatory C = Conditional - = not used	-	C	-	-

Health care item information

Use this group of attributes to provide information about health care.

Level	Component	Base	Case	Pallet
M = mandatory C = conditional - = not used	-	C	C	C

T4273 Does trade item contain latex

BMS ID	1434			
Definition	An indication that the trade item has a positive latex reference on the trade item's labeling.			
Code value	true - Packaging indicates that the product contains latex false - Packaging does not indicate that the product contains latex			
Level	Component	Base	Case	Pallet

M = mandatory C = conditional - = not used	-	C	-	-
---	---	---	---	---

T4435 Does trade item contain human tissue

BMS ID	6089			
Definition	Deattributeines whether the trade item has, as a component or ingredient, human tissue. The amount of tissue is not limited to a certain amount, any amount will cause a flag of TRUE.			
Code value	true – contains human tissue false – Does not contain human tissue			
OBS!	This attribute is part of the ECHO data model; for further guidance and detailed information, see: Common ECHO data model .			
Level	Component	Base	Case	Pallet
M = Mandatory C = Conditional - = not used	-	C	C	-

T4373 Prescription type code

BMS ID	1436			
Definition	The attribute indicates what type of prescription is required or whether it is non-prescription.			
Code value	Specify a code value according to code list "T4373 Prescription type code" see www.gs1.se/en-codelist-t4373			
Level	Component	Base	Case	Pallet
M = mandatory C = conditional - = not used	-	C	C	-

Clinical size

The dimensional size which is clinically relevant for the use of the trade item by the clinical user.

Level	Component	Base	Case	Pallet
M = mandatory C = conditional - = not used	-	C	-	-

T4436 Clinical size type code

BMS ID	6077			
Definition	The qualifier to denote the dimensional size which is clinically relevant for the use of the trade item by the clinical user. For example "NEEDLE_GAUGE" for a 16 gauge needle, or "VOLUME" for a 200 cc syringe.			
Description	<p>Used together with <i>T4478 Clinical size value</i>, <i>T4437 Clinical size value maximum</i> and/or <i>T4438 Clinical size description</i>.</p> <p>To specify an individual value, the attribute is used together with <i>T4478 Clinical size value</i></p> <p>If a range (minimum and maximum value) needs to be specified, the attribute is used together with <i>T4478 Clinical size value</i> and <i>T4437 Clinical size value maximum</i>.</p> <p>To specify the value in text form, the attribute is used together with <i>T4438 Clinical size description</i>.</p>			
Code value	Code value is specified according to code list: T4436 Clinical size type code			
OBS!	This attribute is part of the ECHO data model; for further guidance and detailed information, see: Common ECHO data model .			
Level	Component	Base	Case	Pallet
M = Mandatory C = Conditional - = not used	-	C	-	-

T4478 Clinical size value

BMS ID	3703			
Definition	The value to denote the dimensional size which is clinically relevant for the use of the trade item by the clinical user. For example 16 gauge for a needle, or 200 cc for a syringe.			
Beskrivning	<p>Used alone for a single value.</p> <p>If a range (minimum and maximum) is required, this attribute is used together with <i>T4437 Clinical size value maximum</i></p> <p>This attribute must always be combined with a valid code in <i>T4436 Clinical size type code</i>.</p>			
OBS!	This attribute is part of the ECHO data model; for further guidance and detailed information, see: Common ECHO data model .			
Nivå	Component	Base	Case	Pallet
O = Obligatorisk V = Villkorlig - = not used	-	C	-	-

T4437 Clinical size value maximum

BMS ID	6379			
Definition	The maximum dimensional size which is clinically relevant for the use of the trade item by the clinical user. For example 16 gauge for a needle, or 200 cc for a syringe.			
Description	Used together with <i>T4478 Clinical size value</i> and must always be combined with a valid code in <i>T4436 Clinical size type code</i> .			
Code value	Code value is specified according to code list:T3780 Measurement unit code			
OBS!	This attribute is part of the ECHO data model; for further guidance and detailed information, see: Common ECHO data model .			
Level	Component	Base	Case	Pallet
M = Mandatory C = Conditional - = not used	-	C	-	-

T4438 Clinical size description

BMS ID	6075			
Definition	This is the text used to to denote the dimensional size which is clinically relevant for the use of the trade item by the clinical user. Use when the clinicalSizeType is coded as "DEVICE_SIZE_TEXT_SPECIFY".			
Description	The term is used together with <i>T4436 Clinical size type code</i> with the code value DEVICE_SIZE_TEXT_SPECIFY.			
OBS!	Only one instruction can be provided for the trade item, but the same instruction may be provided in multiple languages. This attribute is part of the ECHO data model; for further guidance and detailed information, see: Common ECHO data model .			
Level	Component	Base	Case	Pallet
M = Mandatory C = Conditional - = not used	-	C	-	-

Medical device information

Use this group of attributes to provide information about medical devices.

Level	Component	Base	Case	Pallet
M = mandatory C = conditional - = not used	-	C	-	-

T4455 Has device measuring function

BMS ID	6346			
Definition	Indication if the device has a function which measures any type of patient metrics.			
Code value	true – has a measurement function false – does not have a measurement function			
OBS!	This attribute is part of the ECHO data model; for further guidance and detailed information, see: Common ECHO data model .			
Level	Component	Base	Case	Pallet
M = Mandatory C = Conditional - = not used	-	C	-	-

T4456 Is reusable surgical instrument

BMS ID	6359			
Definition	Indication the device is a Reusable Surgical Instrument. 'Reusable surgical instrument' means an instrument intended for surgical use in cutting, drilling, sawing, scratching, scraping, clamping, retracting, clipping or similar procedures, without a connection to an active device and which is intended by the Manufacturer to be reused after appropriate procedures such as cleaning, disinfection and sterilisation have been carried out.			
Code value	true – is reusable false – in not reusable			
OBS!	This attribute is part of the ECHO data model; for further guidance and detailed information, see: Common ECHO data model .			
Level	Component	Base	Case	Pallet
M = Mandatory C = Conditional - = not used	-	C	-	-

T4440 Is trade item implantable

BMS ID	1580			
Definition	Implantable devices are defined as devices that are partly or totally inserted into the human body, as deattributed by local regulations.			
Code value	true – is implantable false – is not implantable			
OBS!	This attribute is part of the ECHO data model; for further guidance and detailed information, see: Common ECHO data model .			
Level	Component	Base	Case	Pallet
M = Mandatory C = Conditional - = not used	-	C	-	-

T4457 Is device exempt from implant obligations

BMS ID	6356			
Definition	Indication the medical device is exempted from specific obligations imposed on implantable devices by the regulation. Refer to EU MDR Article 18/3 Implant Card and Information to be supplied to the patient with an implanted device.			
Description	Must be specified when <i>T4440 Is trade item implantable</i> has value <code>true</code> . Otherwise, the attribute is not used. For types of exempted implants, see point 3 in EU MDR Article 18 Implant Card and information to be provided to patients with implants, as well as any local regulations.			
Code value	<code>true</code> – is exempt from the obligations <code>false</code> – is not exempt from the obligations			
OBS!	This attribute is part of the ECHO data model; for further guidance and detailed information, see: Common ECHO data model .			
Level	Component	Base	Case	Pallet
M = Mandatory C = Conditional - = not used	-	C	-	-

T4274 MRI compatibility code

BMS ID	1581			
Definition	An identification of the compatibility of a trade item for use in the presence of a Magnetic Resonance Imaging (MRI) system.			
Code value	Specify a code value according to code list "T4274 MRI compatibility code," see www.gs1.se/en-codelist-t4274			
Level	Component	Base	Case	Pallet
M = mandatory C = conditional - = not used	-	C	-	-

T4451 Resistance to a surface tension reducing agent indicator

BMS ID	7112			
Definition	The indicator that specifies whether the product is resistant to a surface tension reducing agent.			
Code value	<code>true</code> – is resistant <code>false</code> – is not resistant			
OBS!	This attribute is part of the ECHO data model; for further guidance and detailed information, see: Common ECHO data model .			
Level	Component	Base	Case	Pallet
M = Mandatory C = Conditional - = not used	-	C	-	-

T4434 UDID device count

BMS ID	1583			
Definition	The count of medical devices which are contained inside the Basee item for regulatory purposes." This information is part of the UDID regulatory requirements and would be populated at the lowest level of a hierarchy. Device count is not the same as net content as a single device can contain multiple uses.			
OBS!	This attribute is part of the ECHO data model; for further guidance and detailed information, see: Common ECHO data model.			
Level	Component	Base	Case	Pallet
M = Mandatory C = Conditional - = not used	-	C	-	-

T4458 UDI production identifier type code

BMS ID	6364			
Definition	The Production Identifiers which are used to control the product as relevant for Unique Device Identification (UDI) rules. Example: Expiry Date, Manufacturing Date, Serial Number, Lot (or batch) Number, etc.			
Code value	Code value is specified according to code list: T4458 UDI production identifier type code			
OBS!	This attribute is part of the ECHO data model; for further guidance and detailed information, see: Common ECHO data model.			
Level	Component	Base	Case	Pallet
M = Mandatory C = Conditional - = not used	-	C	-	-

T4275 Initial manufacturer sterilisation code

BMS ID	1593			
Definition	Type(s) of sterilisation that may have been performed by the manufacturer if a trade item is sterile when it comes from the manufacturer.			
Description	Sterilisation refers to any process that effectively kills or eliminates transmissible agents (such as fungi, bacteria, viruses, prions and spore forms etc.) from a surface, equipment, foods, medications, or biological culture medium.			
Code value	Specify a code value according to code list "T4275 Sterilisation type code," see www.gs1.se/en-codelist-t4275			
Level	Component	Base	Case	Pallet
M = mandatory C = conditional - = not used	-	C	-	-

T4431 Initial sterilisation prior to use code

BMS ID	1594			
Definition	This is an indication of the type(s) of sterilisation that is required to be completed by a healthcare provider prior to initial use of the healthcare trade item. Sterilisation refers to any process that effectively kills or eliminates transmissible agents (such as fungi, bacteria, viruses, prions and spore forms etc.) from a surface, equipment, foods, medications, or biological culture medium. Some methods of sterilisation are through the application of heat, radiation, and ethylene.			
Code value	Code value is specified according to code list: T4431 Initial sterilisation prior to use code			
OBS!	This attribute is part of the ECHO data model; for further guidance and detailed information, see: Common ECHO data model .			
Level	Component	Base	Case	Pallet
M = Mandatory C = Conditional - = not used	-	C	-	-

Healthcare trade item reusability information

Provides the ability to specify details about the reusability of a healthcare trade item.

Level	Component	Base	Case	Pallet
M = mandatory C = conditional - = not used	-	C	-	-

T4432 Manufacturer declared reusability type code

BMS ID	1598			
Definition	Deattributeines if the product is intended for single or multiple auses, including the number of validated cycles and the number of times a product can be used according to the manufacturer specifications. It is suggested that medical providers consult the device manufacturer’s Instruction For Use (IFU) for full reusability instructions.			
Code value	Code value is specified according to code list: T4432 Manufacturer declared reusability type code			
OBS!	This attribute is part of the ECHO data model; for further guidance and detailed information, see: Common ECHO data model .			
Level	Component	Base	Case	Pallet
M = Mandatory C = Conditional - = not used	-	C	-	-

T4453 Maximum cycles reusable

BMS ID	1599			
Definition	Maximum number of times this Trade Item can be reused.			
OBS!	This attribute is part of the ECHO data model; for further guidance and detailed information, see: Common ECHO data model .			
Level	Component	Base	Case	Pallet
M = Mandatory C = Conditional	-	C	-	-

- = not used				
--------------	--	--	--	--

Origin

This group of attributes can be used to specify information about the trade item's country of origin.

Level	Component	Base	Case	Pallet
M = mandatory C = conditional - = not used	C	C	-	-

T0168 Country of origin

BMS ID	2794			
Definition	The country in which the trade item has been manufactured, expressed as an ISO code.			
Description	<p>The trade item's country of origin is the country in which its final significant processing took place.</p> <p>The attribute is required for all food and alcoholic beverages.</p> <p>Provide the trade item's country of origin according to applicable definitions and regulations.</p> <p>The attribute can be repeated if the trade item is manufactured in several countries.</p> <p>Do not use the attribute to provide information about the origin of primary ingredient(s) in a food product according to EU regulation 2018/775. Use T4202 Provenance statement for that purpose.</p>			
Code value	<p>Code value is specified according to code list T3784, see www.gs1.se/en-codelist-T3784.</p> <p>Code is specified according to ISO 3166-1 (three digit numeric).</p>			
Level	Component	Base	Case	Pallet
M = mandatory C = conditional - = not used	C	C	-	-

T4202 Provenance statement

BMS ID	2783			
Definition	The geographic area from which the trade item and, if applicable, the trade item's primary ingredient(s) according to EU regulation 2018/775, originates.			
Description	<p>Provide the most specific area available, for example the country, region, commune or mountain range from which the trade item originates.</p> <p>When appropriate, use the attribute to provide information about primary ingredient(s) according to EU regulation 2018/775.</p> <p>In all cases, the information must be provided exactly as it reads on the product packaging.</p> <p>Always specify the information in Swedish.</p>			
Example	<p>Example of how to provide the geographic area from which the trade item originates:</p> <p>"Från Thüringen", "Från Gotland", "Bakade i Sigtuna"</p> <p>Example of how to state the geographical origin of meat products:</p> <p>"Född i Sverige", "Uppfödd i Sverige", "Slaktad i Sverige", "Förädlad i Sverige".</p> <p>Example of how to indicate geographical origin when an ingredient or trade item comes from multiple countries:</p> <p>Honung från Slovenien 80%, Ukraina 20%.</p> <p>Example of how to provide the geographic area from which the primary ingredient(s) originates:</p> <p>"Spenat från EU"; "Yoghurt från Sverige"; [Name of primary ingredient(s)] does not originate from [country or area of origin of the food product]</p>			
Note	<p>T4202 replaces "T5038 Country of origin statement" which has been removed. Information about the country in which the trade item has been manufactured is not given here but in T0168 Country of origin</p> <p>Allows for the representation of the same value in different languages, but not for multiple values.</p>			
Level	Component	Base	Case	Pallet
M = mandatory C = conditional - = not used	C	C	-	-

Product activity details

This group of attributes can be used to specify details on an activity being performed on the trade item (for example bottling) and the geographical region where the activity took place.

Level	Component	Base	Case	Pallet
M = mandatory C = conditional - = not used	-	C	C	.

T4375 Country of activity

BMS ID	2801			
Definition	The geographic area where an activity has taken place.			
Description	<p>The attribute should be used when "T4376 Organic product place of farming code" equals FARMING_COUNTRY_OF_ORIGIN.</p> <p>Read more about how attributes are used for the Euroleaf in the guide for organic products. GS1iEU Organic Products Guideline v1.0.pdf</p>			
Code value	<p>Code value is specified according to code list T3784, see www.gs1.se/en-codelist-T3784.</p> <p>Code is specified according to ISO 3166-1 (three digit numeric).</p>			
Level	Component	Base	Case	Pallet
M = mandatory C = conditional - = not used	-	C	C	-

T4235 Product activity type code

BMS ID	2799			
Definition	A code depicting the type of activity being performed on a trade item for example processing, bottling, manufacturing.			
Example	IMPORTATION FARMING			
Code value	Code value is specified according to code list T4235, see www.gs1.se/en-codelist-T4235 .			
Note	<p>Do not use this attribute to provide information on catch zone for fish. Use T4280 Catch area code instead.</p> <p>Read more about how the attribute is used in the separate Guideline for information on fish traceability.</p> <p>Read more about how attributes are used for the Euroleaf in the guide for organic products. GS1iEU Organic Products Guideline v1.0.pdf</p>			
Level	Component	Base	Case	Pallet
M = mandatory C = conditional - = not used	-	M	M	-

Marks

This group of attributes is used to specify which type of barcode is on the package as well as other possible marks.

Level	Component	Base	Case	Pallet
M = mandatory C = conditional - = not used	-	M	M	M

T4400 Packaging marked language code

BMS ID	2313			
Definition	The language in which text on the packaging is stated.			
Level	Component	Base	Case	Pallet
M = mandatory C = conditional - = not used	-	C	C	-

T4357 Claim marked on package

BMS ID	7235			
Definition	Is the claim, specified by Claim type code in combination with Claim element code. labelled on the product package.			
Description	Use if the product package is labelled with claims, specified in "T4358 Claim type code" and "T4359 Claim element code".			
Level	Component	Base	Case	Pallet
M = mandatory C = conditional - = not used	-	C	C	-

T4358 Claim type code

BMS ID	7237			
Definition	<p>The code that states the type of claim applicable to the product. It may be used alone, or in combination with Claim Element Code to identify a specific element, such as a food ingredient, chemical compound or sustainability factor, to which the claim type applies.</p> <p>For the code value VEGAN, this is only indicated for non-food items. To indicate that a food item is vegan, the code list <i>T4066 Diet type code</i> should be used.</p>			
Description	The degree to which a trade item contains a specific nutrient or ingredient stated in "T4359 Claim element code".			
Code Value	Code value is specified according to code list T4358 Claim type code			
Level	Component	Base	Case	Pallet

M = mandatory C = conditional - = not used	-	C	C	-
---	---	---	---	---

T4359 Claim element code

BMS ID	7233			
Definition	The code that specifies an element, such as a food ingredient, chemical compound or sustainability factor, that is subject to the claim type specified by the Claim Type Code.			
Description	The type of nutrient, ingredient, vitamin and mineral that the health claim is in reference to in "T4358 Claim type code".			
Code value	Code value is specified according to code list T4359 Claim element code .			
Level	Component	Base	Case	Pallet
M = mandatory C = conditional - = not used	-	C	C	-

T4356 Claim description

BMS ID	7239			
Definition	Free text field for any additional type of product claims like nutritional, health claims, etc.			
Example	"sockerfri"			
Level	Component	Base	Case	Pallet
M = mandatory C = conditional - = not used	-	C	C	-

T4032 Trade item date on packaging format type code

BMS ID	2334			
Definition	Code indicating the type of expiration date marked on the packaging, as governed by local rules and regulations.			
Code value	Code value is specified according to code list T4032, see www.gs1.se/en-codelist-T4032 .			
Level	Component	Base	Case	Pallet
M = mandatory C = conditional - = not used	-	C	C	C

T3362 Trade item date on packaging format name

BMS ID	2331			
Definition	Formats indicating how dates on the package is printed in plain text.			

<p>Description</p>	<p>The attribute describes how dates in plain text are printed on the package, and is for example used for best-before date.</p> <p>The attribute is not used if the product has unlimited shelf life, that is, is not date-marked.</p> <p>The attribute is mandatory for foods and pharmaceutical consumer units, with some exceptions.</p> <p>yyyy Year yy Year in century y Year in decennium mm Month number mmm Month short name d Day of week (Monday = 1) dd Day of month ` ` - Space and hyphen to be included if used</p> <p>The following date information is allowed for food:</p> <ul style="list-style-type: none"> ■ day, month, year ■ day, month ■ month, year ■ year 			
<p>Example</p>	<p>Example of date specifications:</p> <ul style="list-style-type: none"> ■ Example 1: The package is marked with "30-04-02" (day-month-year). Specify "dd-mm-yy". ■ Example 2: The package is marked with "30 apr" (day-of-month month-short-name). Specify "dd mmm". <p>If the packaging is marked with a date that does not fit within the field's 10 characters, the format of the date must be shortened. Recommendation:</p> <ul style="list-style-type: none"> ■ Example 3: The packaging is marked "Januari 2014". Abbreviate the month name to 3 characters by entering "mmm yyyy". ■ Example 4: The packaging is marked "20-APR-2014". Delete the punctuation marks and enter "ddmmmyyyy". 			
<p>Level</p> <p>M = mandatory C = conditional - = not used</p>	<p>Component</p> <p>-</p>	<p>Base</p> <p>C</p>	<p>Case</p> <p>C</p>	<p>Pallet</p> <p>-</p>

T3777 Packaging marked label accreditation code

<p>BMS ID</p>	<p>2312</p>
<p>Definition</p>	<p>The code representing a symbol or marking on the product and/or product package defined by a third party. This does not include regulatory markings.</p>
<p>Description</p>	<p>The attribute may be repeated as many times as needed for an item.</p>
<p>Code value</p>	<p>The code value is specified according to code list T3777, see www.gs1.se/en-codelist-T3777.</p>
<p>Note</p>	<p>The packaging must be marked with the symbol specified in the attribute. For example, the code value FRAN_SVERIGE is only stated when the Från Sverige symbol is on the packaging.</p>

Level	Component	Base	Case	Pallet
M = mandatory C = conditional - = not used	-	C	C	-

T3850 Compulsory additive label information

BMS ID	1457			
Definition	A description of any other compulsory label information on the product.			
Description	<p>Can be used if there isn't any other specific field for compulsory information. Information written in connection with the regulated product name of the food product, must be typed in T3850.</p> <p>T3850 can also be used for optional information such as important consumer information or other informational text.</p> <p>For information texts and information to consumers for dietary supplements, information should be entered in T3850.</p> <p>Always specify the information in Swedish.</p> <p>Read more in the section Examples of what to specify in T4088 Ingredient statement and in T3850 Compulsory additive label information.</p>			
Example	<p>"ej ätbart korvskinn"</p> <p>"överdriven konsumtion kan ha laxerande effekt."</p> <p>"Kosttillskott bör inte användas som ett alternativ till en varierad kost och hälsosam livsstil"</p>			
Note	Allows for the representation of the same value in different languages, but not for multiple values.			
Level	Component	Base	Case	Pallet
M = mandatory C = conditional - = not used	-	C	C	-

T4272 Has batch number

BMS ID	2306			
Definition	Indication whether the base trade item is batch or lot number requested by law, not batch or lot number requested by law but batch or lot number allocated, or not batch or lot number allocated.			
Description	A batch or lot number is a manufacturer-assigned code used to identify a trade item's trade item on batch or lot. Differs from Serial Number which is a			
	manufacturer-assigned code during the trade item on cycle to identify a unique trade item.			
Code Value	<p>true - the product has a batch number</p> <p>false - the product does not have a batch number</p>			
Level	Component	Base	Case	Pallet

M = mandatory C = conditional - = not used	-	C	C	-
--	---	---	---	---

T4281 Sun protection factor

BMS ID	273			
Definition	A measure of Ultraviolet B (UVB) radiation protection, ranging from 1 to 90			
Description	The attribute can be used for any product that has a sun protection factor.			
Example	30			
Level	Component	Base	Case	Pallet
M = mandatory C = conditional - = not used	-	C	C	-

Data carrier

This group of attributes can be used to describe what information and type of data carrier is present on a trade item. The group is only used if the trade item is or could be marked with machine-readable information.

Level	Component	Base	Case	Pallet
M = mandatory C = conditional - = not used	-	C	C	C

T3748 Application identifier type code

BMS ID	3477			
Definition	Code indicating which type of information (application identifier) that is present in the marking that is readable by a machine.			
Example	10=batch number 15=best before date			
Code value	Code value is specified according to code list T3748, see www.gs1.se/en-codelist-T3748 .			
Level	Component	Base	Case	Pallet
M = mandatory C = conditional - = not used	-	C	C	C

T4310 Data carrier type code

BMS ID	3480			
Definition	Code indicating the type of data carrier physically present on the trade item.			

Code value	Code value is specified according to code list T4310, see www.gs1.se/en-codelist-T4310 .			
Level	Component	Base	Case	Pallet
M = mandatory C = conditional - = not used	-	M	M	M

T3747 Data carrier presence code

BMS ID	3479			
Definition	A code that indicates if the trade item has or could have a certain data carrier present.			
Example	ALWAYS – Trade Item always includes an AI in AIDC format. SOMETIMES – Trade Item sometimes includes an AI in AIDC format			
Code value	Code value is specified according to code list T3747, see www.gs1.se/en-codelist-T3747 .			
Level	Component	Base	Case	Pallet
M = mandatory C = conditional - = not used	-	C	C	C

Trade item external information

This group of attributes can be used to specify links to additional information about the trade item. If there are several links to external information the whole class is repeated for every link.

Level	Component	Base	Case	Pallet
M = mandatory C = conditional - = not used	-	C	C	C

T2231 Referenced file type code

BMS ID	2999			
Definition	Code indicating the purpose of the linked information.			
Code value	Code value is specified according to code list T2231, see www.gs1.se/en-codelist-T2231 .			
Level	Component	Base	Case	Pallet
M = mandatory C = conditional - = not used	-	M	M	M

T4329 Is primary file

BMS ID	3001			
Definition	Is the referenced file primary			
Description	Indicates whether a URL for the file specified in "T2231 Referenced file type", links to the primary file that should be used.			

Level	Component	Base	Case	Pallet
M = mandatory C = conditional - = not used	-	C	C	C

T2232 Content description

BMS ID	2986			
Definition	Free form description of the content of the external link.			
Description	Always specify the information in Swedish.			
Note	Allows for the representation of the same value in different languages, but not for multiple values.			
Level	Component	Base	Case	Pallet
M = mandatory C = conditional - = not used	-	C	C	C

T2238 File format name

BMS ID	2993			
Definition	The name of the file format.			
Description	If the file is an image, the file format name must be present if the "T3405 Uniform Resource Identifier" is entered.			
Example	PDF JPEG BMP			
Level	Component	Base	Case	Pallet
M = mandatory C = conditional - = not used	-	C	C	C

T2233 File name

BMS ID	2995			
Definition	The name of the file that contains the external information.			
Description	If the file is an image the file name must be present if the "T3405 Uniform Resource Identifier" is entered.			
Level	Component	Base	Case	Pallet
M = mandatory C = conditional - = not used	-	C	C	C

T3405 Uniform Resource Identifier

BMS ID	3000			
Definition	Link to website with information on this trade item.			
Description	If there is a legislation that regulates product information, then the regulation also applies to the linked information.			
Level	Component	Base	Case	Pallet
M = mandatory C = conditional - = not used	-	C	C	C

T4473 File effective start date time

BMS ID	2990			
Definition	The date upon which the target of this external link begins to be effective for use.			
Description	Times are expressed in UTC (Coordinated Universal Time), with a UTC designator ("Z").			
Level	Component	Base	Case	Pallet
M = Mandatory C - Conditional - = Not used	-	C	C	C

T4474 File effective end date time

BMS ID	2989			
Definition	The date upon which the target of this external link ceases to be effective for use.			
Description	Times are expressed in UTC (Coordinated Universal Time), with a UTC designator ("Z").			
Level	Component	Base	Case	Pallet
M = Mandatory C - Conditional - = Not used	-	C	C	C

Duty fee taxes

This group of attributes can be used to specify which tax and tax rate apply to the item, as well as subsidies for the item. This group is mandatory for base level items.

Level	Component	Base	Case	Pallet
M = mandatory C = conditional - = not used	-	M	C	-

T4499 Duty Fee Tax Type Description

BMS ID	1153			
Definition	A description of tax type for example "Taxes sure les supports audio".			
Level	Component	Base	Case	Pallet
M = Mandatory C - Conditional - = Not used	-	C	C	-

T4033 Duty fee tax agency code

BMS ID	1146			
Definition	Code indicating the agency responsible for the tax code list			
Code Value	Code value is specified according to code list T4033. See www.gs1.se/en-codelist-t4033 .			
Level	Component	Base	Case	Pallet
M = mandatory C = conditional - = not used	-	M	C	-

T0194 Duty fee tax type code

BMS ID	1152			
Definition	Code which indicates the tax type.			
Code Value	Code value is specified according to code list T0194, see www.gs1.se/en-codelist-T0194 .			
Level	Component	Base	Case	Pallet
M = mandatory C = conditional - = not used	-	M	C	-

Duty fee tax

Details on a duty, fee or tax which may be applicable to a trade item including applicability, rate and amount.

Level	Component	Base	Case	Pallet
M = mandatory C = conditional - = not used	-	C	C	C

T4500 Duty fee tax country code

BMS ID	1149			
Definition	The country that a duty, fee or tax may be applicable to for a trade item.			
Code value	Code value is specified according to code list: T3783 Target market country code .			
Level	Komponent	Bas	Mellan	Topp
M = Mandatory C - Conditional - = Not used	-	C	C	-

T4501 Duty Fee Tax Amount

BMS ID	1171			
Definition	The current tax or duty or fee amount applicable to the trade item.			
Note	Code value for currency is specified according to code list T0204 Currency			
Level	Component	Base	Case	Pallet
M = Mandatory C - Conditional - = Not used	-	C	C	-

T0195 Duty fee tax rate

BMS ID	1178			
Definition	The current tax rate percentage applicable to the trade item.			
Description	<p>The tax rate is stated in percent. It is not allowed to complete the field with fill-out zeros or to complete the field with zeros after a decimal.</p> <p>The duty fee tax rate should be stated with a period (.) as a decimal point.</p>			
Example	<p>25% is stated as 25</p> <p>12% is stated as 12</p> <p>6% is stated as 6</p> <p>0% is stated as 0</p>			
Note	For information on tax rates, visit the tax authority's website for the respective country.			
Level	Component	Base	Case	Pallet
M = mandatory C = conditional - = not used	-	M	C	-

T4502 Duty Fee Tax Basis

BMS ID	1173			
Definition	This is defined as a taxation Baseis for a corresponding levying type and class for example for a steel tax on an item with a screw cap weighing "3" grams, the tax Baseis would be 3 grams.			
Example	For an item with a steel screw cap, where the steel corresponds to 3 grams, the taxation basis is 3 grams.			
Note	Code value for meadurement is specified according to code list T3780 Measurement unit			
Level	Component	Base	Case	Pallet
M = Mandatory C - Conditional - = Not used	-	C	C	-

T4428 Duty fee tax category code

BMS ID	1175			
Definition	Depicts the applicability of the tax rate or amount for a trade item, for example, zero low or exempt.			
Code value	Code value is specified according to code list: T4428 Duty fee tax category code			
OBS!	This attribute is part of the ECHO data model; for further guidance and detailed information, see: Common ECHO data model.			
Level	Component	Base	Case	Pallet
M = Mandatory C = Conditional - = not used	-	M	C	-

Applicable allowance charge

Specifies allowances and charges applicable to a trade item

Level	Component	Base	Case	Pallet
M = mandatory C = conditional - = not used	-	C	C	C

T4481 Allowance charge type code

BMS ID	3355			
Definition	The identification of an allowance charge selected from a predefined list.			
Code value	Code value for is specified according to code list T4481 Allowance charge type code			
Level	Component	Base	Case	Pallet
M = Mandatory C - Conditional - = Not used	-	M	M	M

T4479 Allowance charge description

BMS ID	3352			
Definition	A text explanation of the allowance or charge.			
Definition	The attribute can be used to provide information regarding, for example, the splitting of the packaging and whether it results in any fees.			
Level	Component	Base	Case	Pallet
M = Mandatory C - Conditional - = Not used	-	C	C	-

T4482 Allowance or charge type

BMS ID	3356			
Definition	Code specifying whether this is an allowance or a charge.			
Code value	Code value for is specified according to code list T4482 Allowance or charge type			
Level	Component	Base	Case	Pallet
M = Mandatory C - Conditional - = Not used	-	M	M	M

T4509 Allowance charge amount

BMS ID	3350			
Definition	Amount of allowance or charge applicable.			
Note	Code value for currency is specified according to code list T0204 Currency			
Level	Component	Base	Case	Pallet
M = Mandatory C - Conditional - = Not used	-	C	C	C

T4480 Allowance charge percentage

BMS ID	3354			
Definition	Allowance and charges can be expressed in different ways. By using percentage, they are expressed as a percentage of another amount, e.g. the Base amount.			
Level	Component	Base	Case	Pallet
M = Mandatory C - Conditional - = Not used	-	C	C	C

T4483 Amount per unit

BMS ID	3357			
Definition	Allowance/charge per unit expressed as an amount.			
Note	Code value for currency is specified according to code list T0204 Currency			
Level	Component	Base	Case	Pallet
M = Mandatory C - Conditional - = Not used	-	C	C	C

Registration information

Information on any registration numbers issued for the trade item.

Level	Component	Base	Case	Pallet
M = mandatory C = conditional - = not used	-	C	C	-

T4464 Registration agency

BMS ID	708			
Definition	An agency that issues registration numbers for any item or substance for example a chemical that is contained within the product.			
Level	Component	Base	Case	Pallet
M = Mandatory C - Conditional - = Not used	-	C	C	-

T4465 Registration number

BMS ID	710			
Definition	A registration number for any item or its constituents.			
Level	Component	Base	Case	Pallet
M = Mandatory C - Conditional - = Not used	-	C	C	-

Packaging hierarchy

This group of attributes is used to specify which and how many items are included in the item. This group is used for every trade item that is not at base level. Read more about how this group is used in chapter [Describing a trade item hierarchy in Trade Item Information](#).

Level	Component	Base	Case	Pallet
M = mandatory C = conditional - = not used	-	-	M	M

T4034 Quantity of children

BMS ID	199
---------------	-----

Definition	The number of unique next lower level trade items contained in a complex trade item.			
Description	A homogeneous trade item contains 1 GTIN at next lower level. A combined trade item contains 2 or more different GTINs at next lower level. Read more about how this attribute is used in chapter Describing a trade item hierarchy in Trade Item Information .			
Example	2			
Level	Component	Base	Case	Pallet
M = mandatory C = conditional - = not used	-	-	M	M

T4035 Total quantity of next lower level trade item

BMS ID	200			
Definition	The total quantity of next lower level trade items that this trade item contains.			
Description	Total quantity of next lower level trade item is not permitted to be changed without assigning the trade item a new GTIN (Global Trade Item Number). Read more about GS1's GTIN rules at www.gs1.org/gtinrules . Read more about how this attribute is used in chapter Describing a trade item hierarchy in Trade Item Information .			
Level	Component	Base	Case	Pallet
M = mandatory C = conditional - = not used	-	-	M	M

Trade item hierarchy

This group of attributes is repeated for every item that is included in the item. Read more about how this group is used in chapter [Describing a trade item hierarchy in Trade Item Information](#).

Level	Component	Base	Case	Pallet
M = mandatory C = conditional - = not used	-	-	M	M

T2045 Child trade item, GTIN

BMS ID	203			
Definition	Item/service included in a product hierarchy or in a mixed range or assortment product			

Description	GTIN of a trade item contained in the mixed pack or multipack. This trade item must be specified in the same message. Read more about how this attribute is used in chapter Describing a trade item hierarchy in Trade Item Information . Included item or service GTIN is not permitted to be changed without assigning the trade item a new GTIN (Global Trade Item Number). Read more about GS1's GTIN rules at www.gs1.org/qtintules .			
Level	Component	Base	Case	Pallet
M = mandatory C = conditional - = not used	-	-	M	M

T3361 Quantity of next lower level trade item

BMS ID	202			
Definition	Number of contained items in this item.			
Description	Count of the number of contained packages in the mixed pack or multipack. Read more about how this attribute is used in chapter Describing a trade item hierarchy in Trade Item Information .			
Level	Component	Base	Case	Pallet
M = mandatory C = conditional - = not used	-	-	M	M

Trade item components

This group of attributes is used to provide information about constituent parts of a trade item that do not have their own GTIN. The parts may be packaged individually within a larger package or packaged separately. In the Swedish market, this group of attributes is only used at base level. See examples and instructions for using components in chapter [Application Instructions for Components](#).

Level	Component	Base	Case	Pallet
M = mandatory C = conditional - = not used	-	C	-	-

T3832 Total quantity of components

BMS ID	316			
Definition	The total quantity of components included in this trade item.			
Description	Read more about how the attribute is used in chapter Application Instructions for Components .			
Example	Pizza set containing 2 bags of pizza dough and 1 bag of tomato sauce. Total number of quantity in a set: 3			
Level	Component	Base	Case	Pallet
M = mandatory C = conditional - = not used	-	M	-	-

T3833 Number of unique components

BMS ID	317			
Definition	The number of different types of components included in this trade item.			
Description	Read more about how the attribute is used in chapter Application Instructions for Components .			
Example	Pizza set containing 2 bags of pizza dough and 1 bag of tomato sauce. Total number of different components in a set: 2 (pizza dough + tomato sauce)			
Note	The value in this attribute must be greater than 1; otherwise you should not use the classes Trade Item Components or Component.			
Level	Component	Base	Case	Pallet
M = mandatory C = conditional - = not used	-	M	-	-

T3838 Multiple container quantity

BMS ID	318			
Definition	The quantity of containers when the complete trade item is packed in multiple containers.			
Description	If all components are packed together into one item this attribute is not used			
Example	A camping set with 1 table and 4 chairs where each unit is packed in its own container. Total number of container: 5 (1 table + 4 chairs)			
Level	Component	Base	Case	Pallet
M = mandatory C = conditional - = not used	-	C	-	-

Component

This group of attributes is used to refer to individual components of an article. It can be repeated per component type. Note: This group of attributes should be linked to "T3815 Context identification", "T0280 GPC category code" and any other groups of attributes that you can add to the component level.

Although all modules are technically applicable, not all types of attributes shall be used on components but only those that are approved in Swedish implementation by the Swedish Trade Item Information User Group. The application can vary depending on the product. Usage limitations are determined by the Swedish Trade Item Information User Group.

Level	Component	Base	Case	Pallet
M = mandatory C = conditional - = not used	C	-	-	-
Note	If you are using the Component class, you must enter values in attributes Component Description (T3835), Component Number (T3834), and Component Quantity (T3837).			

T3834 Component number

BMS ID	322			
Definition	Indicates a sequence number of a <u>component</u> of a trade item.			
Description	Read more about how the attribute is used in chapter Application Instructions for Components .			
Example	Pizza set containing 2 bags of pizza dough and 1 bag of tomato sauce Sequence number for component "Pizza dough" = 1 Sequence number for component "Tomato sauce" = 2			
Note	The value of T3834 should be unique per unique component within the composite trade item.			
Level	Component	Base	Case	Pallet
M = mandatory C = conditional - = not used	M	-	-	-

T3836 Component identification

BMS ID	325			
Definition	An identifier for a component.			
Description	Field that can be used by the manufacturer to identify the component. E.G internal part numbers or other identity that is not a GTIN. Read more about how the attribute is used in chapter Application Instructions for Components .			
Example	AAA12345			
Note	The value of T3836 must be unique per unique component within the composite trade item.			
Level	Component	Base	Case	Pallet
M = mandatory C = conditional - = not used	M	-	-	-

T3837 Component quantity

BMS ID	331			
Definition	Specifies the number of the same kind of component found in the trade item.			
Description	Read more about how the attribute is used in chapter Application Instructions for Components .			
Example	A pizza set that contains 2 bags of pizza dough and 1 bag of tomato sauce. Number of components "Pizza dough" = 2			
Note	See examples and instructions for this attribute in chapter Application Instructions for Components .			
Level	Component	Base	Case	Pallet

M = mandatory C = conditional - = not used	M	-	-	-
---	---	---	---	---

T3835 Component description

BMS ID	320			
Definition	A description of the component.			
Description	Always specify the information in Swedish Read more about how the attribute is used in chapter Application Instructions for Components .			
Example	A pizza set that contains 2 bags of pizza dough and 1 bag of tomato sauce. Component description for the component "Pizza dough" = Pizza dough			
Note	Allows for the representation of the same value in different languages, but not for multiple values.			
Level	Component	Base	Case	Pallet
M = mandatory C = conditional - = not used	M	-	-	-

T3839 Component multiple packed quantity

BMS ID	330			
Definition	The quantity of containers when this component of the trade item is packed in multiple containers.			
Description	If all quantity of this component is packed together into one item this attribute is not used			
Example	A camping set with 1 table and 4 chairs. Table in 1 box, 2 chairs each in a box for a total of 3 boxes Component Chair: Enter 2 Component Table: Enter:1			
Level	Component	Base	Case	Pallet
M = mandatory C = conditional - = not used	C	-	-	-

T3815 Context identification (Linked from component)

For a single trade item, different sets of modules may be required depending on how the trade item is used. The attribute controls the validation depending on the product group specified.

T0280 GPC category code (Linked from component)

Code indicating the classification category (brick code) for the component according to GPC. The attribute should always be specified once per component.

Extensions - Attributes or modules that can be applied on component level

In this section, it will be specified what groups of attributes that can be applied on component level. There is

a global recommendation on a number of modules or attributes applicable. The Swedish User Group for Trade Item Information decides which of these that can be applied to the Swedish market. The following attributes are:

- T4088 Ingredient statement
- T4069 Preparation state code
- T4070 Daily value intake reference
- T3820 Nutrient basis quantity type code
- T3824 Nutrient Basis Quantity
- T4399 Nutrient basis quantity description
- T4076 Daily value intake percent
- T4073 Nutrient type code
- T4075 Measurement precision code
- T4074 Quantity contained
- T4356 Claim description
- T0082 Net content
- T0168 Country of origin
- T4202 Provenance statement
- T2208 Alcohol percentage
- T4203 Vintage
- T5036 Non-food ingredient statement
- T4271 Alcoholic beverage sugar content

Serving information

This group of attributes can be used to specify the number of servings and the number of smallest units per package.

Level	Component	Base	Case	Pallet
M = mandatory C = conditional - = not used	-	C	C	C

T4092 Number of servings per package

BMS ID	1364			
Definition	Number of servings per package.			
Description	Number of servings that is stated on the package. Number of servings is mandatory if the nutrient facts are specified per serving.			
Example	15			
Level	Component	Base	Case	Pallet
M = mandatory C = conditional - = not used	-	C	C	C

T4036 Number of smallest units per package

BMS ID	1366			
Definition	The total number of smallest units contained in the product. The smallest unit cannot be further divided without breaking or slicing the product. The smallest units may be uniform or may include a variety of items.			
Description	<p>The smallest unit cannot be further divided without breaking or slicing the product. The attribute specifies the number of chicken drumsticks, pancakes, meatballs, etc. The information can be used by large-scale kitchens to plan purchases.</p> <p>The attribute can be used together with "T4093 Maximum number of smallest units per package" to describe an interval for the number of smallest units per package.</p> <p>This attribute specifies the minimum number of smallest units per package.</p>			
Example	<p>A package contains 12-14 chicken drumsticks.</p> <ul style="list-style-type: none"> ■ "T4036 Number of smallest units per package": 12 ■ "T4093 Maximum number of smallest units per package": 14 			
Level	Component	Base	Case	Pallet
M = mandatory C = conditional - = not used	-	C	C	C

T4093 Maximum number of smallest units per package

BMS ID	1363			
Definition	The maximum number of smallest units contained in the package.			
Description	The attribute can be used together with "T4036 Number of smallest units per package" to describe an interval for the number of smallest units per package, see the comment for "T4036 Number of smallest units per package".			
Level	Component	Base	Case	Pallet
M = mandatory C = conditional - = not used	-	C	C	C

Ingredient information

The group can be used for specifying ingredient information corresponding to the information provided for the consumer.

Level	Component	Base	Case	Pallet
M = mandatory C = conditional - = not used	C	C	C	C

T4088 Ingredient statement

BMS ID	1268			
Definition	Information on the constituent ingredient make up of the product specified as one string.			
Description	<p>The attribute is used to specify the ingredients as printed on the package or via QR-code. If the information relates to any foods intended for sale in Sweden, the text must follow the rules of the EU-regulation 1169/2011.</p> <p>Allergens must be included in the ingredient statement and must be marked with uppercase.</p> <p>Example: MJÖLK.</p> <p>Do not use references that require the consumer to have the physical product in front of them because it is not apparent online, eg "För allergener, se fet stil".</p> <p>This attribute has a technical capacity of 5,000 characters, however it is recommended to use maximum 548 characters, which is the capacity most Swedish food retailers can handle.</p> <p>Recommendation for ingredient statement:</p> <ul style="list-style-type: none"> ■ 548 characters ■ If an ingredient has extra information indicated by an asterisk (*), enter any such information at the end of the ingredient statement. ■ If "Spår av" information is stated on the packaging, this must be stated in T4088, regardless of where the information is located on the package. ■ The information "Contains source of phenylalanine" is stated in T4088. ■ If an ingredient is followed by an asterisk, the reference text must always be entered in T4088. ■ For items that contain meat, the ingredient statement should end with the percentage of meat and fat stated as "Kötthalt XX%. Fetthalt XX%". ■ Information about country of origin should be stated in "T4202 Provenance statement". ■ Indicate whether the ratio of collagen to meat protein is less than XX%, regardless of whether ingredients are specified. <p>Specify the information in Swedish.</p> <p>Read more in the section Examples of what to specify in T4088 Ingredient statement and in T3850 Compulsory additive label information.</p>			
Note	<p>Can be repeated with different content and in different languages.</p> <p>The attribute is applicable to food. For non-food, use "T5036 Non-food ingredient statement". For animal feed, use "T4248 Feed composition statement".</p>			
Level	Component	Base	Case	Pallet
M = mandatory C = conditional - = not used	C	C	C	C

Nutritional information

This group of attributes is used to state whether the nutritional values apply to the the product in its prepared or unprepared state, and to specify the quantity upon which the stated nutritional values are based.

Level	Component	Base	Case	Pallet
M = mandatory C = conditional - = not used	C	C	C	C

T4069 Preparation state code

BMS ID	1717			
Definition	Code specifying whether the nutritional values apply to the prepared or unprepared state of the product.			
Description	<p>The code value for preparation state controls the nutrient facts being referred to.</p> <p>The nutrient facts must be stated for food when selling it, but can instead, when appropriate, be stated for the foodstuff after preparation, on condition that there are sufficiently detailed instructions. It is therefore possible to only include the nutrient information for the foodstuff when it is ready to be consumed.</p>			
Example	<p>Example 1: A package contains instant mashed potato powder. The mashed potatoes are cooked by adding the powder to boiling water.</p> <ul style="list-style-type: none"> ■ State "Unprepared" when the nutritional information concerns the powder. ■ State "Prepared" when the nutritional information concerns the mashed potatoes. <p>Example 2: A bag contains baked bread.</p> <ul style="list-style-type: none"> ■ State "Unprepared" since the nutritional information concerns the baked bread. <p>Example 3: A bottle contains an undiluted fruit drink. The fruit drink is mixed by adding water.</p> <ul style="list-style-type: none"> ■ State "Unprepared" when the nutritional information concerns the undiluted fruit drink. <p>State "Prepared" when the nutritional information concerns the fruit drink when it is mixed with water.</p>			
Code value	Code value is specified according to code list T4069, see www.gs1.se/en-codelist-T4069 .			
Level	Component	Base	Case	Pallet
M = mandatory C = conditional - = not used	M	M	M	M

T4070 Daily value intake reference

BMS ID	1712			
Definition	The daily value intake base on which the daily value intake per nutrient has been based.			
Description	<p>Always specify the information in Swedish.</p> <p>RDI according to the Daily value intake reference specified here is expressed per nutrient in the attribute "T4076 Percentage of daily value intake".</p>			
Example	För en 2000 kcal diet			
	RDI			
Level	Component	Base	Case	Pallet
M = mandatory C = conditional - = not used	C	C	C	C

T3820 Nutrient basis quantity type code

BMS ID	1716			
Definition	The type of quantity contained for example measurement, serving size, or container.			
Description	<p>Nutrient basis quantity type can either be based on measurement or serving size. It can, for example, be per 100 grams, or per portion of X number of grams serving size.</p> <p>Specify the basic quantity type used in this attribute, the size in "T3824 Nutrient basis quantity" and the unit of measure in "T3780 Measurement unit code".</p>			
Example	<p>BY_MEASURE – By measure: Per 100 gram</p> <p>BY_SERVING – By Serving 372 g Serving Size</p>			
Code value	Code value is specified according to code list T3820, see www.gs1.se/en-codelist-T3820 .			
Level	Component	Base	Case	Pallet
M = mandatory C = conditional - = not used	C	C	C	C

T3824 Nutrient basis quantity

BMS ID	1714
Definition	The basis amount that a nutrient is measured against when it is not serving size. For example, 120 gr in the case of 30 kj per 120 gr.
Example	<p>Per 100 grams:</p> <ul style="list-style-type: none"> ■ T3824 Nutrient Basis Quantity: 100 ■ "T3780 Unit of measure" for Nutrient Basis Quantity : GRM – gram

Code value	Code value for measurement unit is specified according to code list "T3780 Measurement unit code", see www.gs1.se/en-codelist-T3780 . For "T3824 Nutrient Basis Quantity" unit choose code value: GRM - gram MLT- milliliter H87 - piece			
Level	Component	Base	Case	Pallet
M = mandatory C = conditional - = not used	C	C	C	C

T4399 Nutrient basis quantity description

BMS ID	5872			
Definition	Additional free text information needed to correctly express nutrient basis quantity for example per bottle (100 ml).			
Description	The manufacturer´s recommendation on the serving size. Always specify the information in Swedish.			
Example	per 150 g 1 kaka (19g)			
Note	Allows for the representation of the same value in different languages, but not for multiple values.			
Level	Component	Base	Case	Pallet
M = mandatory C = conditional - = not used	C	C	C	C

Nutrient facts

The group is used for specifying nutrient facts. The attributes in the group are repeated for each nutrient type.

Combined products consisting of components that do not have their own GTINs should have a single, combined nutritional declaration for all components. If the combined product consists of items that have their own GTIN, report the information separately for each item.

The group is only used if the group "Nutrient information" is used.

Level	Component	Base	Case	Pallet
M = mandatory C = conditional - = not used	C	C	C	C

T4076 Daily value intake percent

BMS ID	1731
---------------	------

Definition	Percentage of daily value intake.			
Description	The percentage of daily value intake is expressed relative to "T3824 Nutrient Basis Quantity", and "T4070 Daily value intake reference". It is recommended that the percentage of daily value intake variation is not specified with a greater accuracy than whole per cent.			
Example	8% is stated as 8			
Level	Component	Base	Case	Pallet
M = mandatory C = conditional - = not used	C	C	C	C

T4073 Nutrient type code

BMS ID	1733			
Definition	Code indicating a nutrient that the product contains.			
Description	Use codes to express every nutrient specified. The code list is a selection of codes from INFOODS' code list. The selection of codes is recommended for the Swedish market. See also the EU-regulation 1169/2011 on how to specify nutrients.			
Code value	Code value is specified according to code list T4073, see www.gs1.se/en-codelist-T4073 .			
Level	Component	Base	Case	Pallet
M = mandatory C = conditional - = not used	M	M	M	M

T4075 Measurement precision code

BMS ID	1732			
Definition	Code indicating whether the specified nutrient content is exact or approximate.			
Code value	Code value is specified according to code list T4075, see www.gs1.se/en-codelist-T4075 .			
Level	Component	Base	Case	Pallet
M = mandatory C = conditional - = not used	M	M	M	M

T4074 Quantity contained

BMS ID	1734			
Definition	Measurement value indicating the amount of nutrient contained in the product.			
Example	Example 1: 42 gram <ul style="list-style-type: none"> ■ "T4074 Quantity contained": 42 ■ "T3780 Measurement unit code" for quantity contained: GRM 			

	Example 2: 430 kJ <ul style="list-style-type: none"> ■ "T4074 Quantity contained": 430 ■ "T3780 Measurement unit code" for quantity contained: KJO 			
Code Value	Code value for measurement unit to "T4074 Quantity contained" is specified according to code list "T3780 Measurement unit code", see www.gs1.se/en-codelist-T3780 . For "T4074 Quantity contained" choose one of following code values: E14 – kilocalories GRM – gram KJO – kilojoules MC – microgram MGM – milligram			
Level	Component	Base	Case	Pallet
M = mandatory C = conditional - = not used	M	M	M	M

T4407 Nutrient name on package

BMS ID	7244			
Definition	The name of the nutrient as it is listed on the fact panel on the package. Only used when the Nutrient Name on Package is different than the Nutrient Code (nutrientTypeCode). Frequently used for supplements.			
Example	"T4073 Nutrient type code": X_OMEGA_3_OTHER "T4407 Nutrient name on package": EPA+DHA			
Level	Component	Base	Case	Pallet
M = mandatory C = conditional - = not used	V	V	V	V

Allergen information

This group of attributes can be used to state information concerning allergens. Allergens are specified with the attributes "T4078 Allergen type code", "T4079 Level of containment code", and "T4088 Ingredient statement".

Level	Component	Base	Case	Pallet
M = mandatory C = conditional - = not used	-	C	C	C

T4077 Allergen statement

BMS ID	370			
Definition	Textual description on allergens.			
Description	<p>The attribute may only be used to provide information about allergens in free text.</p> <p>For food products: If the product contains several allergens that are missing in the allergen type code list, then the allergens are specified as a string using this attribute. The attribute may only be used to indicate allergens that are not present in the T4078 Allergen type code list.</p> <p>For alcohol products: Enter all allergens present in the product.</p> <p>Specify the information in Swedish.</p> <p>The Swedish Food Agency gives instructions for allergen statements, see www.slv.se.</p>			
Note	<p>When the product itself constitutes an allergen (e.g. egg), the corresponding allergen type shall be specified in <i>T4078 Allergen type code</i>.</p> <p>Allows for the representation of the same value in different languages, but not for multiple values.</p>			
Level	Component	Base	Case	Pallet
M = mandatory C = conditional - = not used	-	C	C	C

Allergen

This group of attributes is stated once per allergen.

Level	Component	Base	Case	Pallet
M = mandatory C = conditional - = not used	-	C	C	C

T4078 Allergen type code

BMS ID	375
Definition	Code indicating the type of allergen.
Description	<p>Code stated here is not communicated to the consumer but is used as support in the supplier's and / or recipients' systems.</p> <p>The type of allergen can be specified for food, cosmetics, and other product groups in which such substances are present.</p>
Code value	Code value is specified according to code list T4078, see www.gs1.se/en-codelist-T4078 .
Note	<p>The attributes T4079 Level of containment code and T4078 Allergen Type code should only be provided when T4088 Ingredient statement contains information about allergens.</p> <p>When the product itself constitutes an allergen (e.g. egg), the</p>

	corresponding allergen type shall be specified in <i>T4078 Allergen type code</i> . If the trade item lacks an ingredient list and T4088 is not filled in, T4077 Allergen Statement should instead be used to indicate whether the product contains allergens.			
Level	Component	Base	Case	Pallet
M = mandatory C = conditional - = not used	-	M	M	M

T4079 Level of containment code

BMS ID	376			
Definition	Code indicating the level of presence of the allergen or additive.			
Code value	Code value is specified according to code list T4079, see www.gs1.se/en-codelist-T4079 .			
Note	The attributes T4079 Level of containment code and T4078 Allergen Type code should only be provided when T4088 Ingredient statement contains information about allergens. If the trade item lacks an ingredient list and T4088 is not filled in, T4077 Allergen Statement should instead be used to indicate whether the product contains allergens.			
Level	Component	Base	Case	Pallet
M = mandatory C = conditional - = not used	-	M	M	M

Diet type

The group can be used for describing the diet or diets the product is suitable for.

Level	Component	Base	Case	Pallet
M = mandatory C = conditional - = not used	-	C	C	C

T4066 Diet type code

BMS ID	1066			
Definition	Code indicating the diet the product is suitable for.			
Description	Diet type can be specified for foods, cosmetics, and other product groups.			
Code value	Code value is specified according to code list T4066, see www.gs1.se/en-codelist-T4066 .			
Level	Component	Base	Case	Pallet

M = mandatory C = conditional - = not used	-	C	C	C
---	---	---	---	---

T4279 Diet type subcode

BMS ID	1067			
Definition	Indicates a set of agreements or a certificate name that guarantees the product is permitted in a particular diet.			
Description	<p>Use T4066 Diet type code to provide an overall diet type, for example "vegetarian".</p> <p>Use T4279 Diet type subcode to provide a more specific diet type belonging to the overall diet type provided in T4066 Diet type code, for example "ovo" or "lacto".</p>			
Example	Lacto-ovo			
Code value	See full list of code values in code list T4279, www.gs1.se/en-codelist-T4279 .			
Note	T4279 Diet type subcode, should NOT be used when the diet type "vegan" has been specified in T4066.			
Level	Component	Base	Case	Pallet
M = mandatory C = conditional - = not used	-	C	C	C

T4312 Is diet type marked on package

BMS ID	6302			
Definition	Code indicating whether the diet type is labelled on the product package.			
Description	Use this attribute when the diet type specified in "T4066 Diet type code" and/or "T4279 Diet type sub code", is labelled on the product package.			
Level	Component	Base	Case	Pallet

Preparation information

This group of attributes can be used to describe how the product has been prepared by the manufacturer and how the user can prepare the product. The manufacturer's preparation method and/or the preparation information for the user may be stated more than once (once for each preparation type).

Level	Component	Base	Case	Pallet
M = mandatory C = conditional - = not used	-	C	C	C

T4138 Manufacturer preparation type code

BMS ID	1353			
Definition	The code specifying the preparation methods the manufacturer has used on the product during the manufacturing process.			

Code value	Code value is specified according to code list T4138 Manufacturer preparation type code .			
Level	Component	Base	Case	Pallet
M = mandatory C = conditional - = not used	-	C	C	C

Preparation information for the user

This group of attributes can be used to describe how to prepare the product.

Level	Component	Base	Case	Pallet
M = mandatory C = conditional - = not used	-	C	C	C

T4082 Preparation type code

BMS ID	1379			
Definition	Code indicating how the product can be prepared.			
Code value	Code value is specified according to code list T4082, see www.gs1.se/en-codelist-t4082 .			
Level	Component	Base	Case	Pallet
M = mandatory C = conditional - = not used	-	C	C	C

T4083 Preparation instructions

BMS ID	1377			
Definition	Instruction on how to prepare the product.			
Description	Textual instruction on how to prepare the product according to method stated in "T4082 Preparation type code". Specify the information in Swedish.			
Level	Component	Base	Case	Pallet
M = mandatory C = conditional - = not used	-	C	C	C

T4091 Serving suggestion

BMS ID	1380			
Definition	Free text field for serving suggestion.			

Description	The serving suggestion describes how the product may be served, suitable side dishes etc. Specify the information in Swedish.			
Note	Allows for the representation of the same value in different languages, but not for multiple values.			
Level	Component	Base	Case	Pallet
M = mandatory C = conditional - = not used	-	C	C	C

T4136 Maximum optimum consumption temperature

BMS ID	1371			
Definition	The upper limit consumption temperature of the optimum range of the consumption temperature.			
Description	The optimum range of the consumption temperature is a recommendation and is based on the experience of the individual producer. The temperature is stated as Celsius.			
Example	79			
Code value	Code value for measurement unit to T4136 is specified according to code list "T3781 Temperature measurement unit code", see www.gs1.se/en-codelist-T3781 . For "T4136 Maximum optimum consumption temperature" choose code value: CEL – Celsius			
Level	Component	Base	Case	Pallet
M = mandatory C = conditional - = not used	-	C	C	C

T4137 Minimum optimum consumption temperature

BMS ID	1373			
Definition	The lower limit consumption temperature of the optimum range of the consumption temperature.			
Description	The temperature is stated as Celsius. The optimum range of the consumption temperature is a recommendation and is based on the experience of the individual producer.			
Example	72			
Code value	Code value for measurement unit to T4137 is specified according to code list "T3781 Temperature measurement unit code", see www.gs1.se/en-codelist-T3781 . For "T4137 Minimum optimum consumption temperature" choose code value: CEL – Celsius			
Level	Component	Base	Case	Pallet

M = mandatory C = conditional - = not used	-	C	C	C
--	---	---	---	---

Organism classification

The group is used to categorise and name living organisms according to a hierarchical system.

Level	Component	Base	Case	Pallet
M = mandatory C = conditional - = not used	-	C	C	-

T4325 Genus

BMS ID	2145			
Definition	The Latin name of the genus of a living organism, expressed as a free text string.			
Description	A category ranking below a family and above a species and generally consisting of a group of species exhibiting similar characteristics.			
Example	Prunus			
Level	Component	Base	Case	Pallet
M = mandatory C = conditional - = not used	-	C	C	-

T4326 Species

BMS ID	2147			
Definition	The Latin name of the species of a living organism, expressed as a free text string.			
Description	A fundamental category, ranking below a genus and consisting of related organisms.			
Example	Domestica			
Level	Component	Base	Case	Pallet
M = mandatory C = conditional - = not used	-	C	C	-

Fish reporting information

Information about fish- and seafood products to be reported to the authorities and handled between trading partners.

Level	Component	Base	Case	Pallet
M = mandatory C = conditional - = not used	-	C	C	-

T4228 Species for fishery statistics purposes code

BMS ID	911			
Definition	The FAO 3 Alpha code of the species of fish for fish and seafood			
Description	Read more about how the attribute is used in the separate Guideline for information on fish traceability .			
Example	SAL (Salmon Salar)			
Code value	Code value is specified according to code list T4228, see www.gs1.se/en-codelist-T4228 .			
Level	Component	Base	Case	Pallet
M = mandatory C = conditional - = not used	-	C	C	-

T4229 Species for fishery statistics purposes name

BMS ID	912			
Definition	The scientific name of the seafood.			
Description	<p>The scientific name of the seafood corresponding to the FAO code specified in "T4228 Species for fishery statistics purposes code".</p> <p>To enter the regulated product name, see "T4800 Regulated Product Name".</p> <p>Read more about how the attribute is used in the separate Guideline for information on fish traceability.</p>			
Example	Salmo Salar			
Level	Component	Base	Case	Pallet
M = mandatory C = conditional - = not used	-	C	C	-

T4401 Fish seafood presentation code

BMS ID	7213			
Definition	The code that indicates the state or form of a fish/seafood product as presented to the consumer, possibly as a result of post-catch processing (e.g., tail removed, gutted, or filleted)			
Description	<p>The information indicates the way in which a fish product is offered when sold to the consumer.</p> <p>This preparation can be done either by the supplier or the retailer or other parties involved. The style of preparation may be determined by either industry standards, the supplier or the retailer.</p> <p>Read more about how the attribute is used in the separate Guideline for information on fish traceability.</p>			
Example	FILLETED - Filleted			

Code value	Code value is specified according to code list T4401 Fish seafood presentation code .			
Level	Component	Base	Case	Pallet
M = mandatory C = conditional - = not used	-	C	C	-

Fish catch information

Details on the catch of a fish.

Level	Component	Base	Case	Pallet
M = mandatory C = conditional - = not used	-	C	C	-

T4230 Catch method code

BMS ID	914			
Definition	The code indicating what type of fishing gear was used to catch fish and seafood.			
Description	<p>This required attribute will help the global retail industry to fulfil the EU requirements for a common fisheries policy.</p> <p>Read more about how the attribute is used in the separate Guideline for information on fish traceability.</p>			
Example	03 – Trawls			
Code value	Code value is specified according to code list T4230, see www.gs1.se/en-codelist-t4230 .			
Remark	Multiple catch methods can be indicated for the trade item; the attribute is repeatable. At least one value must be numeric.			
Level	Component	Base	Case	Pallet
M = mandatory C = conditional - = not used	-	C	C	-

T4280 Catch area code

BMS ID	6147			
Definition	The sea zone in which the seafood in the trade item was caught.			
Description	Read more about how the attribute is used in the separate Guideline for information on fish traceability .			
Code value	Code value is specified according to code list T4280, see www.gs1.se/en-codelist-t4280 .			
Level	Component	Base	Case	Pallet

M = mandatory C = conditional - = not used	-	C	C	-
---	---	---	---	---

T4231 Production method for fish and seafood code

BMS ID	915			
Definition	The code indicating how the fish and seafood were grown and harvested or caught.			
Description	Read more about how the attribute is used in the separate Guideline for information on fish traceability .			
Example	Enter code value AQUACULTURE if the oysters come from an oyster culture			
Code value	Code value is specified according to code list T4231, see www.gs1.se/en-codelist-t4231 .			
Level	Component	Base	Case	Pallet
M = mandatory C = conditional - = not used	-	C	C	-

T4232 Storage state code

BMS ID	916			
Definition	A code depicting that the referred product was previously frozen or not			
Description	Read more about how the attribute is used in the separate Guideline for information on fish traceability .			
Example	Enter code value PREVIOUSLY_FROZEN if the product has previously been frozen.			
Code value	Code value is specified according to code list T4232, see www.gs1.se/en-codelist-t4232 .			
Level	Component	Base	Case	Pallet
M = mandatory C = conditional - = not used	-	C	C	-

Farming and processing information

These attributes relate to any methods or techniques used by a manufacturer or supplier to produce or process a trade item, ingredients, or raw materials.

T4246 Preservation technique code

BMS ID	1262			
Definition	Code value indicating the preservation technique used to preserve the product from deterioration.			
Description	Describes type of processing for, for example, crops, fish and meat. Read more about how the attribute is used in the separate Guideline for			

	<i>information on fish traceability.</i>			
Example	DRYING – The product has been dried BOILING –The product has been boiled			
Code value	Code value is specified according to code list T4246, see www.gs1.se/en-codelist-T4246 .			
Level	Component	Base	Case	Pallet
M = mandatory C = conditional - = not used	-	C	C	-

Organic certification

A certification in relation to a specific organic claim.

T4378 Organic certification identification

BMS ID	5879			
Definition	A number issued to confirm that something has passed organic certification.			
Description	Read more about how attributes are used for the Euroleaf in the guide for organic products. GS1iEU Organic Products Guideline v1.0.pdf			
Example	"FR-BIO-15", "AT-BIO-301"			
Level	Component	Base	Case	Pallet
M = mandatory C = conditional - = not used	-	C	C	-

Organic claim

Any claim to indicate the organic status of a trade item or of one or more of its components.

T4377 Organic trade item code

BMS ID	1248			
Definition	Used to indicate the organic status of a trade item or of one or more of its components.			
Description	Read more about how attributes are used for the Euroleaf in the guide for organic products. GS1iEU Organic Products Guideline v1.0.pdf			
Code value	Code value is specified according to code list T4377, see www.gs1.se/en-codelist-T4377 .			
Level	Component	Base	Case	Pallet
M = mandatory C = conditional - = not used	-	C	C	-

Trade item organic information

Details on the trade item regarding the extent of organic production.

T4376 Organic product place of farming code

BMS ID	1244			
Definition	Indication of the place where the agricultural raw materials of which the product is composed have been farmed. It applies only to the trade item, not ingredient by ingredient.			
Description	Read more about how attributes are used for the Euroleaf in the guide for organic products. GS1iEU Organic Products Guideline v1.0.pdf			
Code value	Code value is specified according to code list T4376, see www.gs1.se/en-codelist-T4376 .			
Level	Component	Base	Case	Pallet
M = mandatory C = conditional - = not used	-	C	C	-

Animal feeding information

Feeding directions for the trade item as it relates to different life stages of the animal to be fed.

Level	Component	Base	Case	Pallet
M = mandatory C = conditional - = not used	-	C	C	-

T4222 Targeted consumption by

BMS ID	389			
Definition	The food is intended by end consumption by this animal(s)			
Description	Read more about how the attribute is used in the separate Implementation guideline for animal feed .			
Example	DOG			
Code Value	Code value is specified according to code list T4222, see www.gs1.se/en-codelist-t4222 .			
Level	Component	Base	Case	Pallet
M = mandatory C = conditional - = not used	-	C	C	-

T4223 Feed type code

BMS ID	388			
Definition	Type of pet food or feed given to wild or domestic animals in the course of animal husbandry.			

Description	Fodder refers particularly to food given to the animals (including plants cut and carried to them), rather than that which they forage for themselves. It includes hay, straw, silage, compressed and pelleted feeds, oils and mixed rations, and sprouted grains and legumes. Read more about how the attribute is used in the separate Implementation guideline for animal feed .			
Example	To indicate that the feed is nutritionally complete, enter: COMPLETE			
Code Value	Code value is specified according to code list T4223, see www.gs1.se/en-codelist-t4223 .			
Level	Component	Base	Case	Pallet
M = mandatory C = conditional - = not used	-	C	C	-

T4250 Feed additive statement

BMS ID	5907			
Definition	List of the animal feed composition data, based on the ingredients contained in the feed, as governed by local rules and regulations.			
Description	Enter additives exactly as they appear on the product packaging. Read more about how the attribute is used in the separate Implementation guideline for animal feed .			
Example	Protein: 25, fett: 15, fibrer: 1,3, aska: 6,1, omega-3 fetter: 6, EPA/DHA: 3			
Note	Allows for the representation of the same value in different languages, but not for multiple values.			
Level	Component	Base	Case	Pallet
M = mandatory C = conditional - = not used	-	C	C	-

T4249 Feed analytical constituents statement

BMS ID	5909			
Definition	List of the analytical constituents or guaranteed analysis of the feed, based on the nutrient analysis of the finished product, as governed by local rules and regulations.			
Description	Enter additives exactly as they appear on the product packaging. Read more about how the attribute is used in the separate Implementation guideline for animal feed .			
Example	Protein: 25, fett: 15, fibrer: 1,3, aska: 6,1, omega-3 fetter: 6, EPA/DHA: 3			
Note	Allows for the representation of the same value in different languages, but not for multiple values.			
Level	Component	Base	Case	Pallet
M = mandatory C = conditional - = not used	-	C	C	-

T4248 Feed composition statement

BMS ID	5911			
Definition	List of the animal feed composition data, based on the ingredients contained in the feed, as governed by local laws and regulations.			
Description	Enter feed composition exactly as it appears on the product packaging. Read more about how the attribute is used in the separate Implementation guideline for animal feed .			
Example	Spannmål, kött & köttbiprodukter (varav 4% kyckling i beige bitar), vegetabiliska biprodukter, oljor & fetter, vegetabiliskt proteinextrakt, mineraler, grönsaker (4% morötter i orange bitar, 4% ärtor i gröna bitar)			
Note	Allows for the representation of the same value in different languages, but not for multiple values.			
Level	Component	Base	Case	Pallet
M = mandatory C = conditional - = not used	-	C	C	-

T4251 Feeding instructions

BMS ID	5913			
Definition	All instructions describing how (e.g. in which amounts or how often) the animal should be fed based on the age, weight, diet or other variables, expressed as free text. Information provided shall be identical to that on the label or pack.			
Description	Read more about how the attribute is used in the separate Implementation guideline for animal feed .			
Example	"Ge en vuxen hund den rekommenderade dagliga utfodringsmängden en gång per dygn. Justera mängden efter din hunds aktivitetsnivå, ras och ålder. Foder som blir över kan kylas upp till 3 dagar. Förvaras svalt."			
Note	Allows for the representation of the same value in different languages, but not for multiple values.			
Level	Component	Base	Case	Pallet
M = mandatory C = conditional - = not used	-	C	C	-

T4410 Animal food type code

BMS ID	7091			
Definition	The code that describes the shape or consistency of the animal food product.			
Description	Read more about how the attribute is used in the separate Implementation guideline for animal feed .			
Example	STICK - Stick			

Code Value	Code value is specified according to code list T4410 Animal food type code .			
Level	Component	Base	Case	Pallet
M = mandatory C = conditional - = not used	-	C	C	-

T4409 Animal targeted health condition code

BMS ID	7096			
Definition	The code that identifies any health conditions that the animal product addresses.			
Description	Read more about how the attribute is used in the separate Implementation guideline for animal feed .			
Example	INDOOR - Inomhus			
Code Value	Code value is specified according to code list T4409 Animal targeted health condition code .			
Level	Component	Base	Case	Pallet
M = mandatory C = conditional - = not used	-	C	C	-

T4425 Feed life stage code

BMS ID	8749			
Definition	The code, as defined by the seller, that describes the generic life stage(s) of the animal for product usage.			
Description	Read more about how the attribute is used in the separate Implementation guideline for animal feed .			
Example	SENIOR-Senior			
Code Value	Code value is specified according to code list T4425 Animal Target Size Code .			
Level	Component	Base	Case	Pallet
M = mandatory C = conditional - = not used	-	C	C	-

T4424 Animal target size code

BMS ID	8751			
Definition	The code, as defined by the seller, that describes the generic size of the animal, in relation to its species, for product usage			
Description	Read more about how the attribute is used in the separate Implementation guideline for animal feed .			
Example	SMALL-Small			

Code Value	Code value is specified according to code list T4424 Feed Life Stage Code .			
Level	Component	Base	Case	Pallet
M = mandatory C = conditional - = not used	-	C	C	-

Animal feeding

Specific feeding directions for the trade item as it relates to different life stages of the animal to be fed.

Level	Component	Base	Case	Pallet
M = mandatory C = conditional - = not used	-	C	C	-

T4208 Feed life stage

BMS ID	399			
Definition	Identifies the life-stage of the animal for which a trade item has been designed for.			
Description	Read more about how the attribute is used in the separate Implementation guideline for animal feed .			
Example	Vuxen 5-8 år			
Note	Allows for the representation of the same value in different languages, but not for multiple values.			
Level	Component	Base	Case	Pallet
M = mandatory C = conditional - = not used	-	C	C	-

T4209 Maximum weight of animal being fed

BMS ID	401			
Definition	The highest weight (in a weight range) of the animal to be fed by the trade item. This value qualifies the quantity of feed for the feed life-stage.			
Description	Read more about how the attribute is used in the separate Implementation guideline for animal feed .			
Example	80 kilogram			
Code Value	Code value for measurement unit is specified according to code list "T3780 Measurement unit code", see www.gs1.se/en-codelist-T3780 . For "Maximum weight of animal being fed", value choose code value: KGM – kilogram			
Level	Component	Base	Case	Pallet

M = mandatory C = conditional - = not used	-	C	C	-
---	---	---	---	---

T4210 Minimum weight of animal being fed

BMS ID	403			
Definition	The lowest weight (in a weight range) of the animal to be fed by the trade item. This value qualifies the quantity of feed for the feed lifestage.			
Description	Read more about how the attribute is used in the separate Implementation guideline for animal feed .			
Example	1 kilogram			
Code Value	Code value for measurement unit is specified according to code list "T3780 Measurement unit code", see www.gs1.se/en-codelist-T3780 . For "T4210 Minimum weight of animal being fed" value choose code value: KGM – kilogram			
Level	Component	Base	Case	Pallet
M = Mandatory C = Conditional - = Not used	-	C	C	-

Animal feeding detail

Detail directions for feeding amount of the trade item as it relates to different life stages of the animal to be fed.

Level	Component	Base	Case	Pallet
M = mandatory C = conditional - = not used	-	C	C	-

T4212 Feeding amount

BMS ID	416			
Definition	The amount of feed which is specified for the feed life-stage and qualified by the weight of animal being fed.			
Description	Read more about how the attribute is used in the separate Implementation guideline for animal feed .			
Example	50 gram			
Code Value	Code value for measurement unit is specified according to code list "T3780 Measurement unit code", see www.gs1.se/en-codelist-T3780 .			
Level	Component	Base	Case	Pallet
M = Mandatory C = Conditional - = Not used	-	C	C	-

T4214 Maximum feeding amount

BMS ID	420			
Definition	The maximum amount of feed which is specified for the feed life-stage and qualified by the weight of animal being fed.			
Description	Read more about how the attribute is used in the separate Implementation guideline for animal feed .			
Example	85 gram			
Code Value	Code value for measurement unit is specified according to code list "T3780 Measurement unit code", see www.gs1.se/en-codelist-T3780 .			
Level	Component	Base	Case	Pallet
M = Mandatory C = Conditional - = Not used	-	C	C	-

T4215 Minimum feeding amount

BMS ID	422			
Definition	The minimum amount of feed which is specified for the feed life stage and qualified by the weight of animal being fed			
Description	Read more about how the attribute is used in the separate Implementation guideline for animal feed .			
Example	38 gram			
Code Value	Code value for measurement unit is specified according to code list "T3780 Measurement unit code", see www.gs1.se/en-codelist-T3780 .			
Level	Component	Base	Case	Pallet
M = Mandatory C = Conditional - = Not used	-	C	C	-

T4216 Recommended frequency of feeding

BMS ID	424			
Definition	How frequently it is recommended to feed an animal the quantity of feed within a time period for the specified feed life-stage.			
Description	Read more about how the attribute is used in the separate Implementation guideline for animal feed .			
Example	per dag dagsbehov			
Note	Allows for the representation of the same value in different languages, but not for multiple values.			
Level	Component	Base	Case	Pallet
M = mandatory C = conditional - = not used	-	C	C	-

How to fill in Trade item information

This section contains examples that show how Trade item information should be filled in for different contexts.

Shelf-edge labels

Shelf-edge labels help the consumer compare different package sizes and brands. This data comes directly from Trade Item Information and it is therefore essential that it be correct. If the description short is wrong on the shelf-edge label, for example, it can be difficult to find the right item on the shelf. The consumer may then choose another item.

The following attributes are fetched from Trade Item Information:

- **T3337 Description short:** The description short must primarily be the same text as the packaging is marked with. Example: Washing powder, Smoothie Eko or Pillar candle stearin. Please note, since there is a limited number of characters on the shelf-edge label and the number of characters on description short can vary, it occurs that the recipient adjusts the text to make it fit.
- **T0143 Brand name:** An identifier that distinguishes your products from others
- **T4360 Descriptive size dimension:** The size printed on the package, for example 750 g or 1.5 l
- **T0147 Price comparison measurement:** Used to calculate the comparative price

Price is set by the store and is not fetched from Trade Item Information.

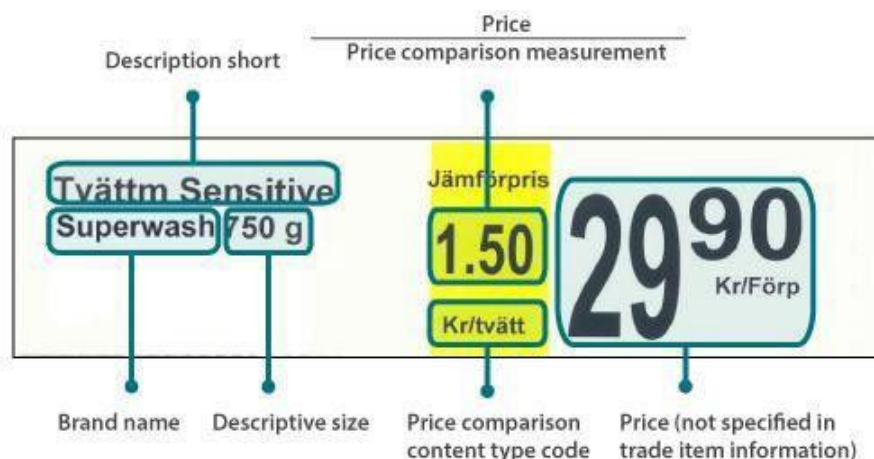

Figure 5 The figure shows an example on how information for a shelf-edge label is fetched from Trade Item Information.



Figure 6 For this washing powder package, the Description short is "Tvättmedel Sensitive", the Brand name is "Superwash" and the Descriptive size is 750 g.

Comparative price

Comparative price is calculated using price and the T0147 Price comparison measurement as follows:

$$\text{Comparative price} = \frac{\text{Price}}{\text{Price comparison measurement}}$$

Note that the store sets the price; it is not fetched from Trade Item Information.

Example of comparative price

The supplier has stated in Trade Item Information that a package of washing powder will provide 20 washes:

- **T0147 Price comparison measurement** = 20
- **T3780 Measurement unit code** = H87 (Piece)
- **T0145 Price comparison content type code** = PER_WASH
- **Price** = 29.90 SEK/package

$$\text{Comparative price} = \frac{29.90}{20} = 1.50 \text{ SEK/wash}$$

Trade Item Information for bake-off bread to be baked in-store

All items which are sold per unit must have a GTIN, even if they are unpacked and do not carry a barcode. The following recommendation applies for dough baked in-store and sold to consumers:

- **T4037 Is trade item a consumer unit** = true (consumer units)
- **T0137 Packaging type code** = 9J (unpacked)

The supplier decides if it is the unbaked dough or the package in which the dough pieces are packed that is the orderable unit. The dough piece's height, width and depth are measured as for a consumer unit.

Trade Item Information for items of varying weight

For items with varying dimensions such as meat, fish, cheese, fruit and vegetables, where the quantity of products in a package varies and the price varies depending on quantity, Trade Item Information is given as follows:

- **T0186 Is trade item a variable unit:** In Trade Item Information this attribute is set to true to show that the item is variable-measure. The attribute is a true/false indicator and is mandatory at all item levels since some items, for example cheese, can have a variable weight at the base unit level but a fixed weight at the case level.
- **T0154 Trade item, GTIN:** A consumer unit with a variable weight is numbered with a variable measure number. Since a GTIN is always 14 digits in Trade Item Information, the 13-digit code should be padded with a leading zero. When a variable-measure number is used in Trade Item Information, the four digits showing the price in crowns or the weight in kilograms are replaced by four zeros and the check digit is recalculated.

Note that it is only the consumer unit, at the base unit level of the item hierarchy, that is numbered with a variable-measure number. Items at the case level and pallet level must not be numbered with a variable measure number, but with a GTIN. [Read more on how to number consumer packages, cases and pallets with variable weight.](#)

- **T4017 Trade item measurements, width; T4019 Trade item measurements, height; T4018 Trade item measurements, depth; T4020 Trade item gross weight and T0082 Net content:** Measure and weigh several units to determine an average value for the item's dimensions and use these in Trade Item Information.

Measurement guide for selected code values in T4362 Size type code

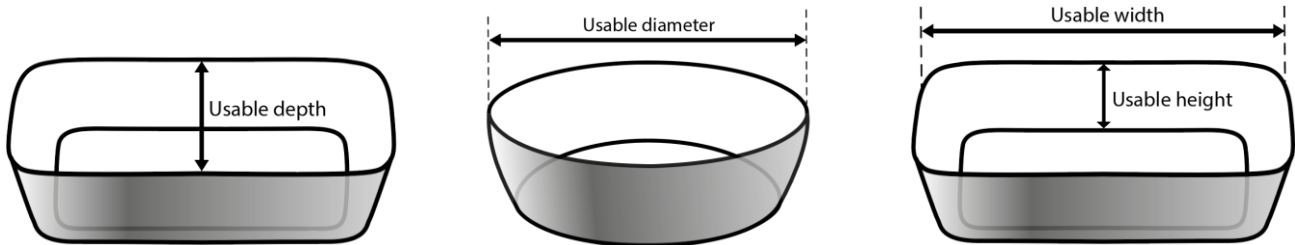

Usable depth: Measurement of the distance from the front to the back inner rims of a product.

Usable diameter: Diameter of the inner rims of a product.

Usable height: Measurement of the distance from the internal highest point of a product to its internal bottom.

Usable width: Measurement of the distance from the left to the right inner rims of a product.

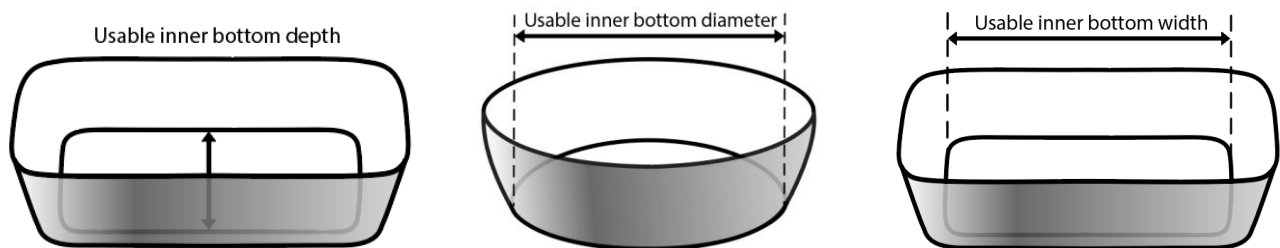

Usable inner bottom depth: Measurement of the distance from the front to the back of the bottom inner rims of a product.

Usable inner bottom diameter: Diameter of the bottom inner rims of a product.

Usable inner bottom width: Measurement of the distance from the left to the right bottom inner rims of a product.

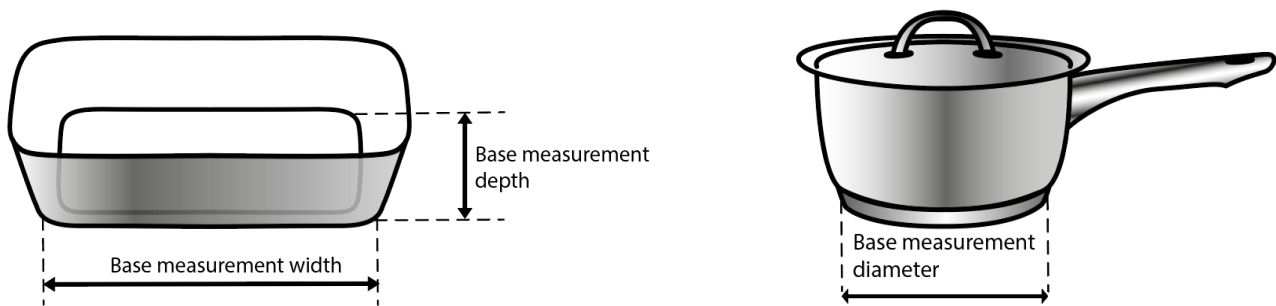

Base measurement depth: Measurement from the front to the back of the outer base of the product.

Base measurement diameter: Diameter of the product's outer base.

Base measurement with: Measurement from the left to the right of the outer base of the product.

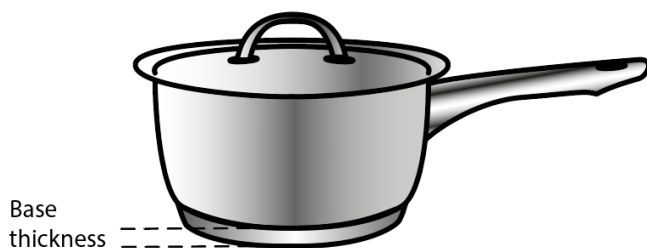

Base thickness: Measurement of the thickness of a products outer base.

Trade Item Information for books and audiobooks

Trade Item Information for books is recorded as follows:

- **T1124 Information provider of trade item, GLN:** GLN for the order recipient, that is, the party from whom the item is ordered. Can be a trading partner or distributor.
- **T0143 Brand name:** Author's name (last name, first name)
- **T0018 Functional name:** Publisher or imprint separated with "/"
- **T3337 Description short:** Book title; may be shortened to fit
- **T4360 Descriptive size dimension:** Type of binding (hardback/paperback/carton/audiobook)
- **T4017 Trade item measurements, width; T4019 Trade item measurements, height; T4018 Trade item measurements, depth:** The dimensions of a book are defined by the front of the book.

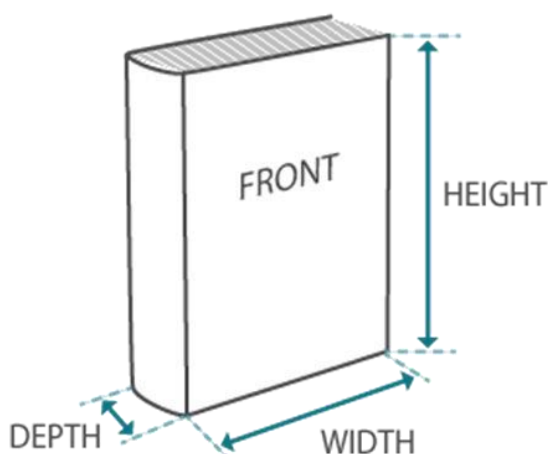

Figure 8 The dimensions of a book are defined by the front of the book.

Trade item levels in a trade item hierarchy

A trade item hierarchy shows, for example, which consumer units are contained in a case, or which cases are contained on a pallet. The buyer needs information about the trade items at each level of the trade item hierarchy. Consequently, Trade Item Information must describe the trade items at each level of the trade item hierarchy.

There are three possible levels in a trade item hierarchy:

- **Base level:** The lowest level of a trade item hierarchy. A trade item at base level contains no items identified with a GTIN. A base level item is always contained in another trade item, which can be at case level or pallet level. **Examples:** A bottle of mineral water or shampoo, or a bucket for the food service industry.
- **Case level:** The middle level of a trade item hierarchy. A trade item at case level contains other trade items and is also itself contained in a trade item. A case-level item can contain items at base level or other case level items. Note that there may be several case-level items in a hierarchy. **Examples:** A box with six bottles of shampoo, a six-pack of mineral water, or a box containing four six-packs of mineral water.
The case level is not always used, for example when the trade item at base level is large. An example is bags of charcoal that are displayed on pallets directly in the store
- **Pallet level:** The highest level of a trade item hierarchy. A trade item at pallet level contains other items but is not itself contained in another trade item. **Examples:** A pallet of boxes containing bottles of shampoo or mineral water.

Each item at the different levels is given a GTIN. Trade Item Information is sent for every GTIN, since they have different attributes, such as different dimensions. Using the item levels, it is easy to describe an item hierarchy.

Summary:

- If the hierarchy consists of only one item level, for example a washing machine, the hierarchy consists of only one item at base level.
- If the hierarchy consists of two item levels, it consists of one item at base level and one item at top level, even if the top level is not a pallet or equivalent.
- If the hierarchy consists of three or more item levels, it consists of one item at base level, one item at top level and one or more levels at case level.

Example 1. A pallet of boxes containing bottles of shampoo

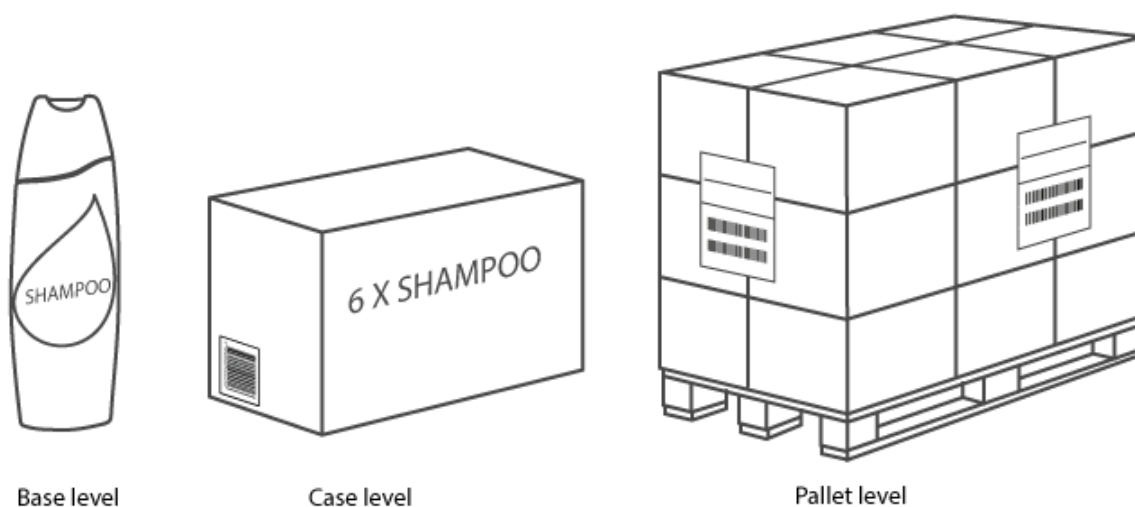

Figure 9 Example of a trade item hierarchy consisting of one base level, one case level and one top level.

Example 2. A pallet of boxes containing 6-packs of mineral water

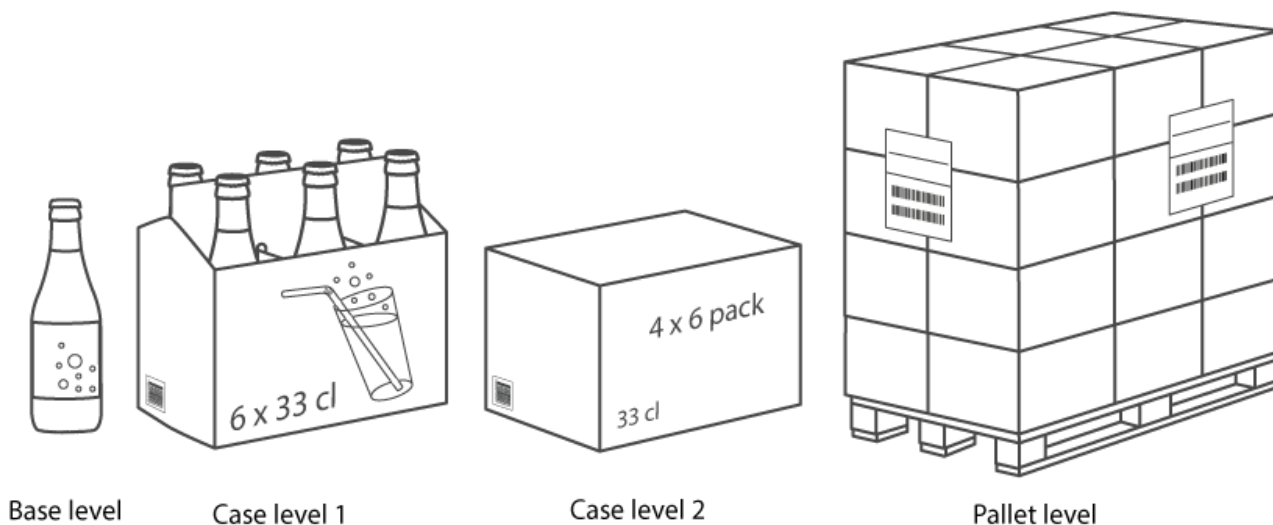

Figure 10 Example of a trade item hierarchy consisting of one base level, two case levels and one top level.

Example 3. Loose items – A pallet with boxes of apples

Apples sold by weight packed in a box

- **Base level:** Box of apples
- **Case level:** No case level if the boxes are on a pallet
- **Pallet level:** Pallet with a number of boxes

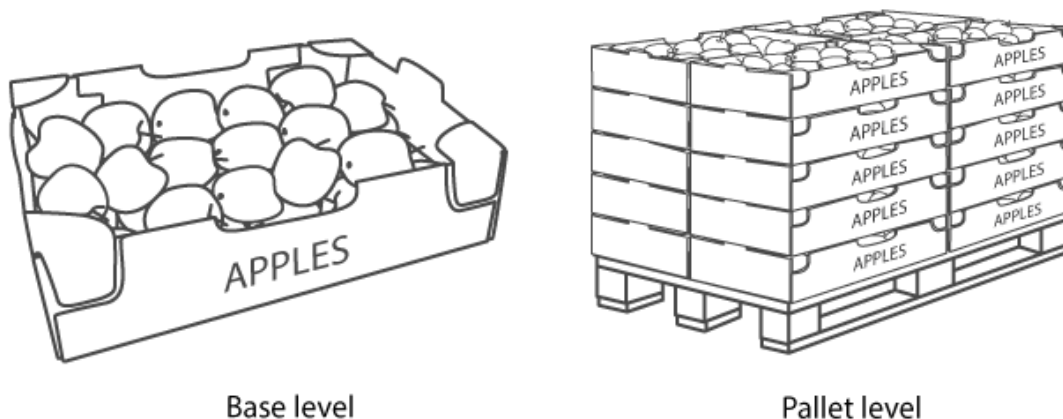

Figure 11 The base-level item is the box of apples and the top-level item is the pallet.

Baking potatoes sold individually, packed in a box

- **Base level:** One unpacked baking potato
- **Case level:** Box of baking potatoes
- **Pallet level:** Pallet with a number of boxes

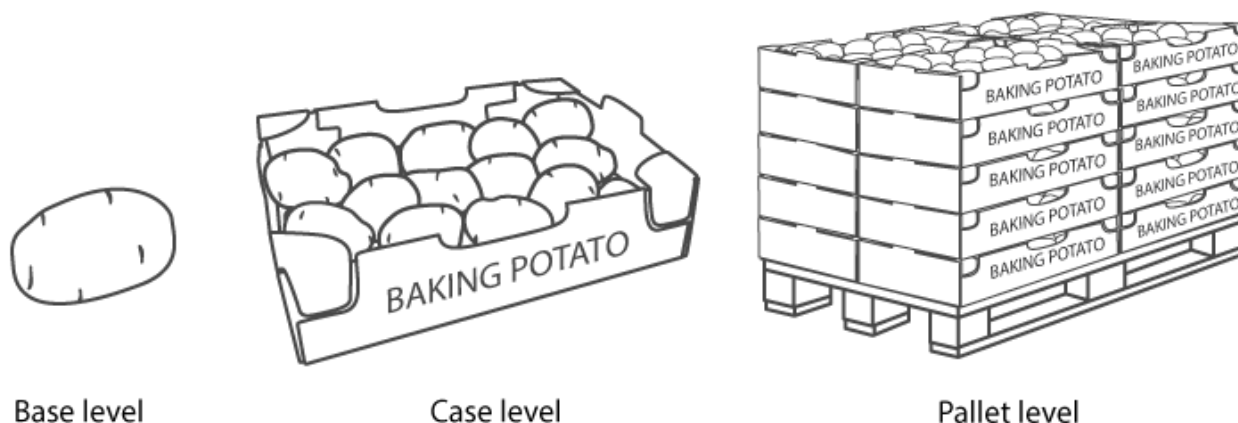

Figure 12 The base-level item is the unpacked baking potato, the case-level item is the box and the pallet-level item is the pallet.

A display pallet often consists of consumer units in opened outer packages.

- **Base level:** One consumer unit of cat food
- **Case level:** No case level
- **Pallet level:** Display pallet with consumer units of cat food in opened outer packages

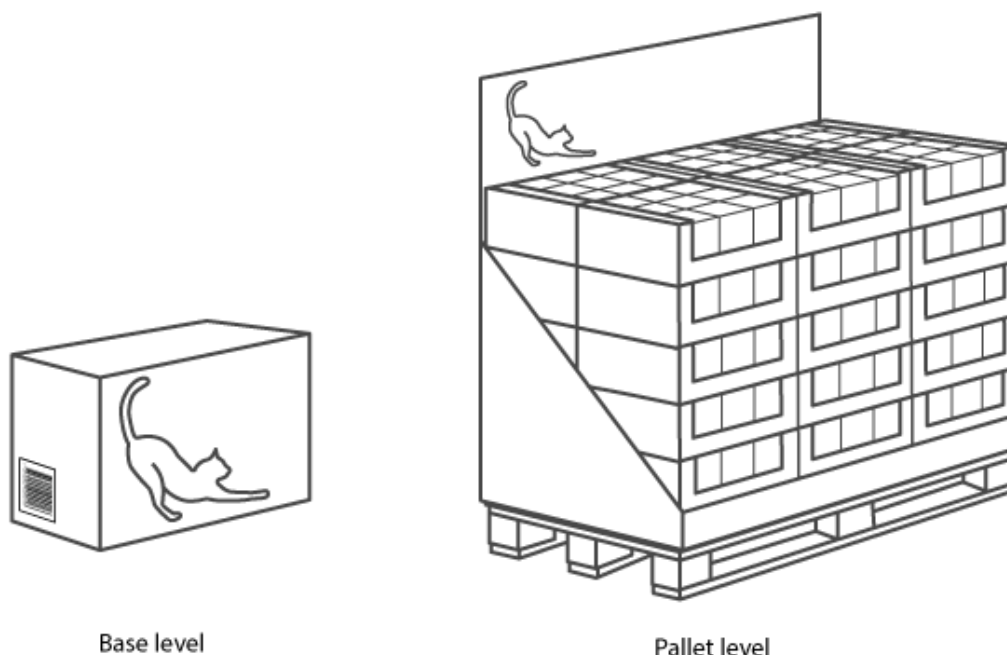

Figure 13 The base-level item is the consumer unit of cat food and the pallet-level item is the display pallet.

Item	T4010 Trade item unit descriptor code	T2045 Child trade item, GTIN	T3361 Quantity of next lower level trade item
Display pallet	Pallet	Consumer unit of cat food	324
Consumer unit of cat food	Base	-	-

Example 6. A brewery pallet

A brewery pallet consists of a full pallet with two half pallets on it. On each half pallet are two trays holding 24 bottles each. Four layers of trays and bottles are stacked on top of each other. At the top of each stack is an empty tray that locks the upper layer of bottles in place. The bottles, trays and pallets have deposits which must be entered in Trade Item Information. Each item can have information on one or more deposits. Each deposit can be associated with a certain quantity.

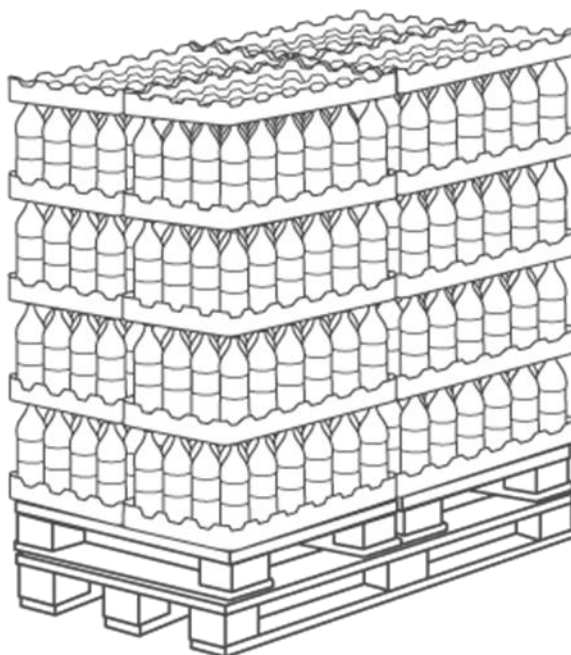

Figure 14 A brewery pallet consists of a full pallet with two half pallets on it.

The item hierarchy consists of three levels:

Pallet level

- The pallet level is the full pallet
- Dimensions and weight include the full pallet's height and weight
- Packaging type: pallet
- If a returnable full pallet with deposit is used, the deposit code for a returnable full pallet is given

Case level

- The case level is the half pallets with the two stacks
- For a mixed pallet, the item hierarchy has several items at case level
- Dimensions and weight include the half pallet's height and weight

- Packaging type: pallet
- If a returnable half pallet with deposit is used, the deposit code for a returnable half pallet is given
- The case-level item also includes the deposit for the 10 trays on each half pallet

Base level

- The lowest level of the item hierarchy is the base level, which in this case is a 1½ liter PET- bottle with beverage
- For a mixed pallet, the item hierarchy has several items at base level
- Deposit code for 1½ liter PET is given

This is how item hierarchies with deposits look for a homogeneous and mixed pallet, respectively:

Example 1. Trade item hierarchy for a homogeneous pallet

Item	T4010 Trade item unit descriptor code	T2045 Child trade item, GTIN	T3361 Quantity of next lower level trade item	T0148 Returnable package deposit identification / T4125 Returnable assets contained quantity
Full pallet	Pallet level	Half pallet	2	Deposit code for returnable full pallet / 1
Half pallet	Case level	Bottle	192	Deposit code for returnable half pallet / 1
Bottle	Base level	-	-	Deposit for PET 1½ l / 1

Example 2. Trade item hierarchy for a mixed pallet

Item	T4010 Trade item unit descriptor code	T2045 Child trade item, GTIN	T3361 Quantity of next lower level trade item	T0148 Returnable package deposit identification / T4125 Returnable assets contained quantity
Full pallet	Pallet level	Half pallet A Half pallet B	1 1	Deposit code for returnable full pallet / 1
Half pallet A	Case level	Bottle A	192	Deposit code for returnable half pallet / 1 Deposit code for tray /10
Half pallet B	Case level	Bottle B	192	Deposit code for returnable half pallet / 1 Deposit code for tray /10
Bottle A	Base level	-	-	Deposit for PET 1½ l / 1
Bottle B	Base level	-	-	Deposit for PET 1½ l / 1

Describing a trade item hierarchy in Trade Item Information

A whole trade item hierarchy is described in Trade Item Information. This includes a description of every contained item at base, case, and pallet level, and their relationship to one another. For each trade item at pallet and case levels, items contained at the next lower level of the hierarchy must be specified.

Example 1. An outer case with three different types of sausage

An outer case consisting of three different types of sausage:

- Salami (GTIN 1), 2 pieces
- Bratwurst (GTIN 2), 4 pieces
- Barbecue (GTIN 3), 3 pieces

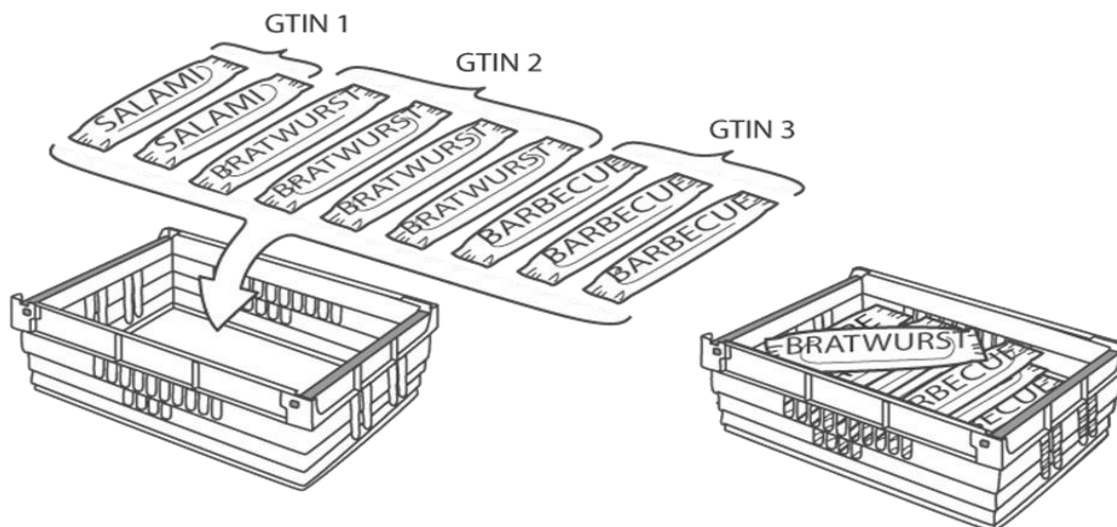

Figure 15 An outer case consisting of three different types of sausage.

The trade item hierarchy for the outer case is described in the groups Packaging hierarchy and Trade item hierarchy as follows:

- Packaging hierarchy
 - **T4034 Quantity of children** = 3 (GTIN 1 + GTIN 2 + GTIN 3)
 - **T4035 Total quantity of next lower level trade item** = 9 (2 + 4 + 3)
- Trade item hierarchy
 - **T2045 Child trade item, GTIN** = GTIN1
 - **T3361 Quantity of next lower level trade item** = 2
 - **T2045 Child trade item, GTIN** = GTIN2
 - **T3361 Quantity of next lower level trade item** = 4
 - **T2045 Child trade item, GTIN** = GTIN3
 - **T3361 Quantity of next lower level trade item** = 3

Example 2. A box containing 6 bottles of glue

A box contains six bottles of glue (GTIN 1). For the homogenous case the hierarchy is described as follows:

- Packaging hierarchy
 - **T4034 Quantity of children** = 1 (GTIN 1)
 - **T4035 Total quantity of next lower level trade item** = 6
- Trade item hierarchy
 - **T2045 Child trade item, GTIN** = GTIN1
 - **T3361 Quantity of next lower level trade item** = 6



Figure 16 A box contains 6 bottles of glue.

Consumer unit, orderable unit and/or despatch unit

A trade item can have a number of attributes related to how it is intended to be sold and distributed at different stages of the supply chain. Any trade item can have attributes indicating that it is a consumer unit, an orderable unit, or a despatch unit.

- **Consumer unit:** The trade item is intended to be sold to a consumer or end user at point-of-sale.
- **Orderable unit:** The trade item is ordered from the supplier by a wholesaler, store, or similar. Every trade item hierarchy contains an orderable unit. In some cases there can be several orderable units in the same hierarchy.
- **Despatch unit:** The trade item, usually a pallet, which is physically delivered from the supplier to the customer. There is always at least one item that is a despatch unit in a hierarchy. Usually the pallet level item is the despatch unit, but if the trade item hierarchy consists of only a base level, the base level is the despatch unit.

Summary:

Note that the same trade item can have more than one of these attributes.

- An item that is a consumer unit can also be orderable (for physically large consumer units there may be no case-level item).
- An orderable unit can also be a despatch unit (for example a display pallet).

Example 1. A pallet of boxes of bottles of shampoo

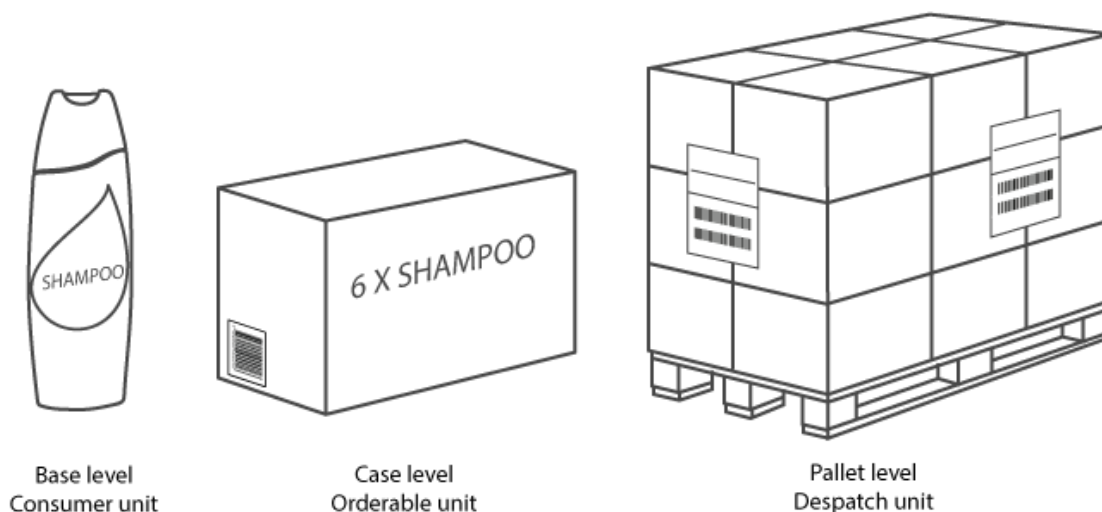

Figure 17 A consumer unit, an orderable unit and a despatch unit in a trade item hierarchy consisting of a base level, a case level, and a logistic level.

Example 2. A pallet of boxes containing 6-packs of mineral water

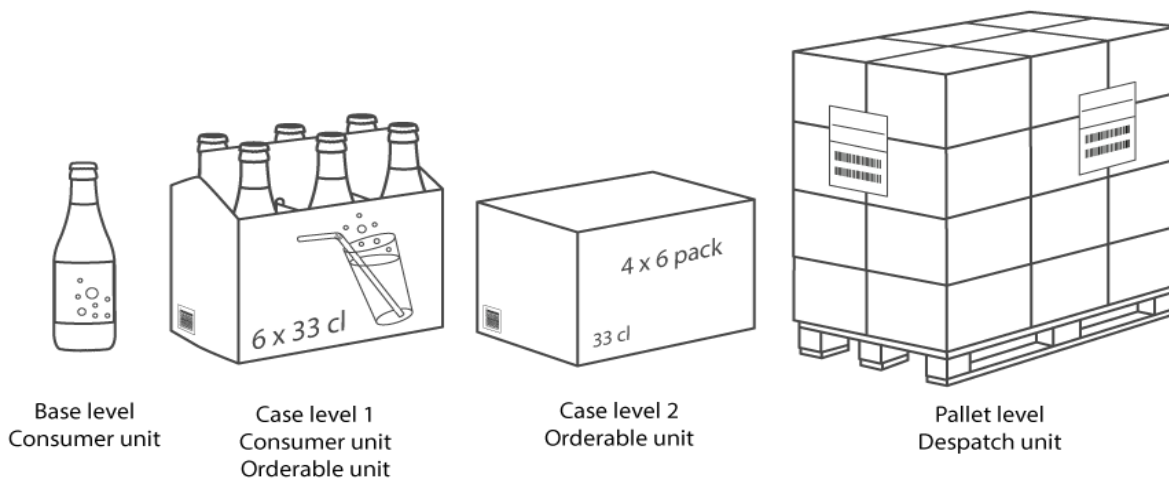

Figure 18 This trade item hierarchy with two case levels features two consumer units and two orderable units. The trade item at the first case level is both a consumer unit and an orderable unit.

Example 3. A display pallet of cat food

A display pallet often consists of consumer units in opened outer packages. In the trade item hierarchy, the consumer unit is the base level and the display pallet is the orderable and logistic unit at pallet level.

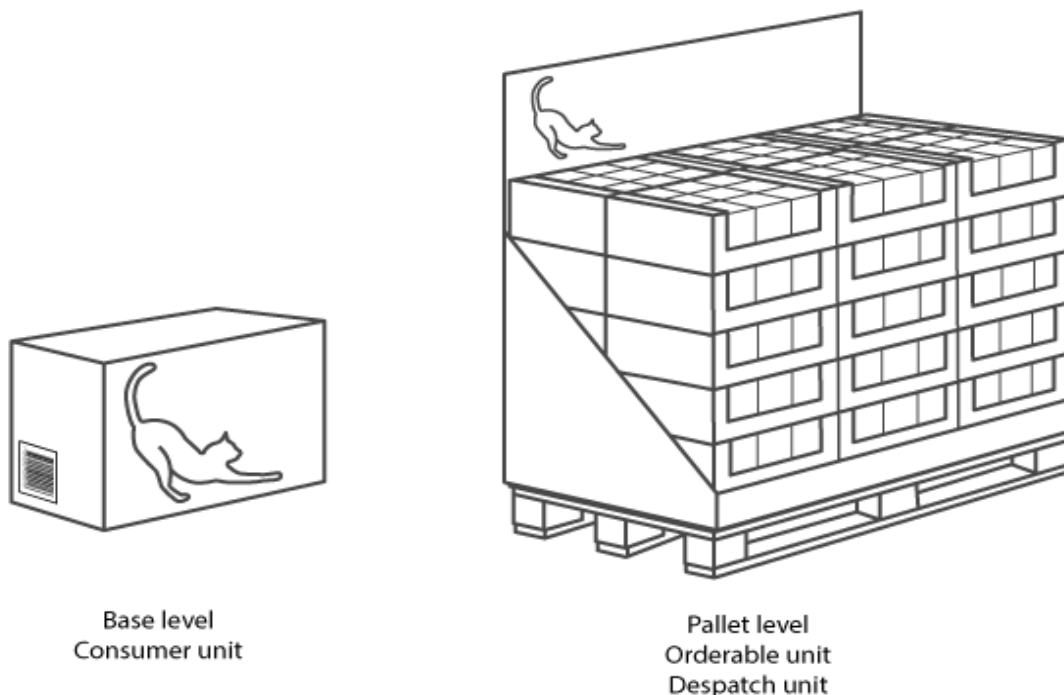

Figure 19 In this trade item hierarchy consisting of a base level and a pallet level, the trade item at pallet level is both an orderable unit and a despatch unit.

Example 4. A pallet of buckets of tzatziki

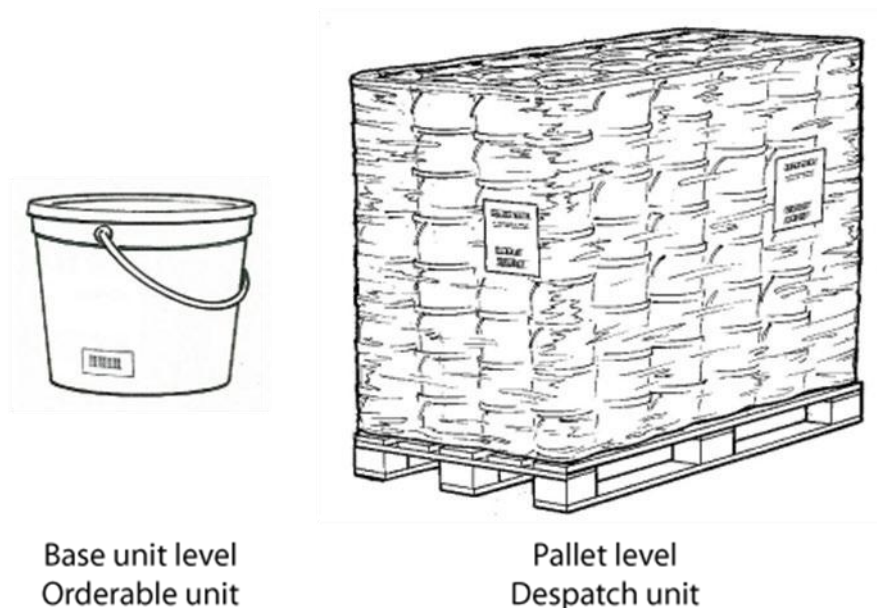

Figure 20 In this trade item hierarchy consisting of a base level and a pallet level, the trade item at base level is an orderable unit and the trade item at pallet level is a despatch unit. No consumer unit is included.

Seasonal goods

Seasonal items are specified by stating the period during which an item is orderable using Start availability date time and End availability date time. If the season is to be changed, the new season is sent as Trade Item Information with the new dates.

An example is given below of a seasonal item which is launched, available for three seasons, and then removed from the product range.

Season 1:

- **T0153 Document command:** New item
- **T4727 Start availability date time:** 2015-10-15
- **T4726 End availability date time:** 2015-12-27

Season 2:

- **T0153 Document command:** Change
- **T4727 Start availability date time:** 2016-10-14
- **T4726 End availability date time:** 2016-12-27

Season 3:

- **T0153 Document command:** Change
- **T4727 Start availability date time:** 2017-10-14
- **T4015 Discontinued date time:** 2017-12-27

Package type and deposit for Svenska Retursystem pallets

For items loaded onto a Svenska Retursystem pallets, Packaging type code, Platform type code and Returnable package deposit identification must be populated. When Validoo Item carries out its validations the load device weight given in the code list is included in the gross weight. In the event that different standard weights are given in the code lists for Platform type and Returnable package deposit, the weight from Returnable package deposit is used.

	T0137 Packaging type code	T2244 Platform type code	T0148 Returnable package deposit identification
SRS returnable half pallet	PX-pallet	10 - ISO 0-pallet	7350000486100
SRS returnable half pallet (brewers)	PX-pallet	10 - ISO 0-pallet	7350000486117
SRS/Paletten black returnable full pallet	PX-pallet	11 - ISO 1-pallet	7350000486308
SRS/Paletten grey returnable full pallet	PX-pallet	11 - ISO 1-pallet	7350000486315

For items with one of Svenska Retursystem's boxes as the packaging type, "T0137 Packaging type code" should be set to CR – Crate and "T0148 Returnable package deposit identification" to the appropriate box type.

For pallets that do not carry a deposit, Packaging type code and Platform type code should be provided. For example, for a single-use half pallet set "T0137 Packaging type code" to PX – Pallet and "T2244 Platform type code" to 10 – ISO 0-pallet.

Trade Item Information to comply with CLP regulation

The CLP regulation specifies how dangerous chemical products must be classified and labelled. The following Trade Item Information attributes are used to fulfill regulatory requirements concerning information on dangerous properties of products and how to protect yourself and the environment:

- T5044 GHS Signal words code
- T5047 Hazard statements code
- T5048 Hazard statements description
- T5049 Precautionary statements code
- T5050 Precautionary statements description

Example: A dangerous chemical product is labelled according to the figure below.

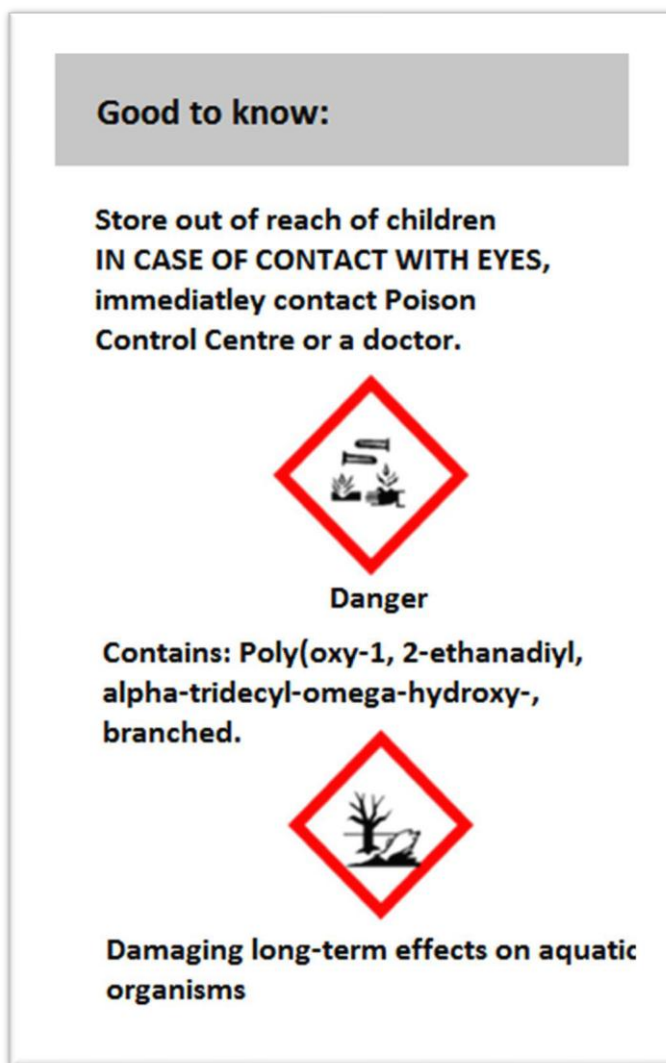

Figure 21 Example of a label on a dangerous chemical product

The information is specified in the Trade Item Information as follows:

Attribute	Information
T5044 GHS Signal words code	Danger
T5047 Hazard statements code	H412
T5048 Hazard statements description	Damaging long-term effects on aquatic organisms
T5049 Precautionary statements code	P102
T5050 Precautionary statements description	Store out of reach of children
T5049 Precautionary statements code	P305
T5050 Precautionary statements description	IN CASE OF CONTACT WITH EYES

T5049 Precautionary statements code	P310
T5050 Precautionary statements description	Immediately contact Poison Control Centre or a doctor. Contains: Poly(oxy-1, 2-ethanediyl), alpha-tridecyl-omega-hydroxy-, branched.

Trade Item Information to comply with MCF guidelines on dangerous goods

This section aims to help you send complete Trade Item Information for products classed as dangerous goods.

MCF provides rules for the transport of dangerous goods in Sweden. Since all goods undergo transport at some point in the supply chain, specific information must be sent in Trade Item Information to meet MCF's requirements. While some information is generally available on product markings or labels, it may not be sufficiently detailed to satisfy MCF's requirements. More detailed information is available in MCF's ADR-S table: [link](#).

The ADR-S table contains information separated into categories, several of which correspond to specific attributes in Trade Item Information.

The table below shows:

- which attributes in Trade Item Information must be populated ("Required")
- which attributes in Trade Item Information may need to be populated ("Conditional") depending on the needs of your data recipient or item properties
- where the information is found in the ADR-S table (see example on next page)

Attributes	Required	Conditional	ADR-S
T0169 United Nations dangerous goods number	<input checked="" type="checkbox"/>		1
T4026 Dangerous goods shipping name	<input checked="" type="checkbox"/>		2
T0263 Class of dangerous goods code	<input checked="" type="checkbox"/>		3a
T4143 Dangerous goods hazardous label number	<input checked="" type="checkbox"/>		5
T3741 ADR tunnel restriction code	<input checked="" type="checkbox"/>		15
T3743 Dangerous goods classification code		<input checked="" type="checkbox"/>	3b
T0264 Dangerous goods packing group		<input checked="" type="checkbox"/>	4
T4142 Dangerous goods special provisions		<input checked="" type="checkbox"/>	6
T4247 Dangerous goods limited quantities code		<input checked="" type="checkbox"/>	7a
T4141 Hazardous material additional information		<input checked="" type="checkbox"/>	
T4751 Dangerous hazardous label sequence number		<input checked="" type="checkbox"/>	5
T4023 Flash point temperature		<input checked="" type="checkbox"/>	
T4027 Dangerous goods technical name		<input checked="" type="checkbox"/>	
T3744 Transport category code		<input checked="" type="checkbox"/>	15
T4040 Handling instructions code reference		<input checked="" type="checkbox"/>	
T4303 Net mass of explosives		<input checked="" type="checkbox"/>	

Note: Attributes marked "Conditional" may be required by your data recipient or due to item properties. For example:

- For flammable liquids transported by sea, T4023 Flash point temperature is required.
- For goods that carry more than one hazardous label number (T4143), T4751 Dangerous hazardous label sequence number is required for each label.

If in doubt, check with your data recipient. Also keep in mind that more information is to be preferred over too little.

Example

Information that is required, but missing from the label, must be fetched from the ADR-S table. Use the information from the label to find the relevant entry in the ADR-S table, and populate your trade item information as indicated below.

Required information is outlined in green, conditionally required information in yellow.

UN-nr	Benämning och beskrivning	Klass	Klassificeringskod	Förpackningsgrupp	Etiketter Sekevn nummer	Särbestämmer Särbestämmer	Begränsade och reducer Begränsad mängd		Transportkategori (Tunnelrestriktionskod)
	3.1.2	2.2	2.2	2.1.1.3	5.2.2	3.3	3.4	3.5.1.2	1.1.3.6 (8.6)
(1)	(2)	(3a)	(3b)	(4)	(5)	(6)	(7a)	(7b)	(15)
1950 T0169	AEROSOLER, brandfarliga T4026	2 T0263	5F T3743		2.1 T4143 T4751*	190 327 344 625	1 L T4247**	E0	2 (D) T3741 T3744

* T4751 Dangerous hazardous label sequence number: Usage

Since the product in the example only has one warning label, it is not necessary to provide attribute **T4751 Dangerous hazardous label sequence number**. Products with several warning labels are shown in the ADR-S table as follows:

Etiketter
Sekvensnummer
5.2.2
(5)
2.3+5.1 +8

In the above case you would enter the following trade item information:

T4143 Dangerous goods hazardous label number	T4751 Dangerous hazardous label sequence number
2.3	1
5.1	2
8	3

** T4247 Dangerous goods limited quantities code: Usage

In Swedish Trade Item Information you do not enter the quantity of the dangerous substance listed in the ADR-S table in the attribute **T4247 Dangerous goods limited quantities code**. You instead use [code list T4247](#) to indicate whether rules exist regulating whether the dangerous good can be packaged in small quantities provided that they are packaged properly.

Application Instructions for Components

This help section aims to make it easier for you to share component information.

Components are used for composite trade items whose unique components or constituents are not labeled with EAN-13 barcode and GTIN. What determines whether you should enter Trade Item Information at base level or on a component is whether there is unique information per component on the trade item's packaging.

If it is unclear whether the information is unique to a component, you should populate the information at the trade item level. If the trade item has only one unique component, you should not use the component feature; you should share all information at trade item level.

To illustrate the above in a simple and clear way, we use a composite trade item containing three different types of sausages. See picture below.

Example: Trade item with three different types of sausage

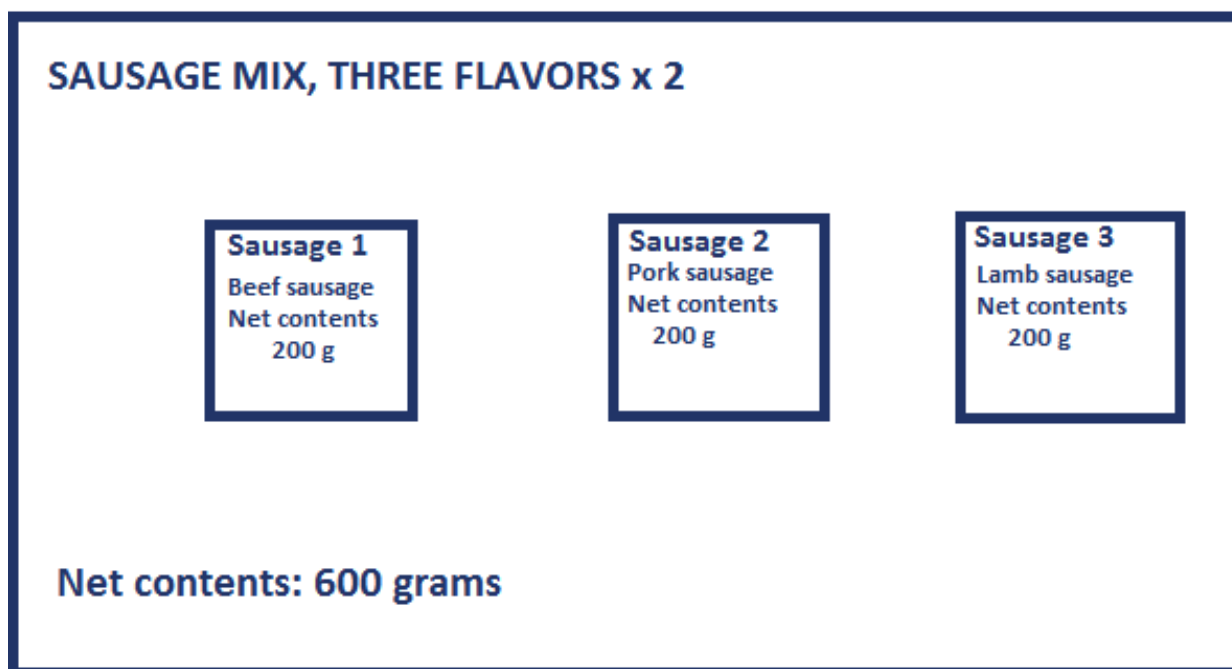

There are three different types of sausages in the composite trade item package. There are two pieces of each type.

For the sake of simplicity, the unique component information on the packaging is that each type has a net content of 200 grams. The composite trade item in its entirety at base level has a net content of 600 grams.

The information is specified in the Trade Item Information as follows. We start with the class "Trade Item Components", which is an overall description of how many components and how many types of components are included.

Attribute or class	Information
Trade Item Components	
T3832 Total quantity of components	6
T3833 Number of unique components	3

Information for each variety is then created by repeating the Component class:

Class Component (Repeated per unique Component)	(Sausage 1)
T3834 Component number	1
T3836 Component identification	111
T3837 Component quantity	2
T3835 Component description	Sausage 1 Beef sausage
T3815 Context identification (linked from component)	DP006 (Food, tobacco and animal food)

T0280 GPC category code (linked from component)	10005833 (beef sausage)
T0082 Net content (linked from component)	200 grams
Class Component (Repeated per unique Component)	(Sausage 2)
T3834 Component number	2
T3836 Component identification	222
T3837 Component quantity	2
T3835 Component description	Sausage 2 Pork sausage
T3815 Context identification (linked from component)	DP006 (Food, tobacco and animal food)
T0280 GPC category code (linked from component)	10005840 (pork sausage)
T0082 Net content (linked from component)	200 grams
Class Component (Repeated per unique Component)	(Sausage 3)
T3834 Component number	3
T3836 Component identification	333
T3837 Component quantity	2
T3835 Component description	Sausage 3 Lamb sausage
T3815 Context identification (linked from component)	DP006 (Food, tobacco and animal food)
T0280 GPC category code (linked from component)	10005835 (lamb sausage)
T0082 Net content (linked from component)	200 grams

Other information stated on the trade item level, e.g. T0082 Net content: 600 grams, T3337 Description short: "SAUSAGE MIX THREE FLAVORS x 2," etc.

T4088 Ingredient statement and T3850 Compulsory additive label information

Below are examples of texts that should be adjacent to the ingredient statement.

If an ingredient is followed by an asterisk (*), the reference text shall always be entered in T4088.

Examples of texts specified in T4088 Ingredient statement

Text	Specified in
Innehåller lakrits – personer som lider av högt blodtryck bör undvika överdriven konsumtion.	T4088
Innehåller en fenylalaninkälla.	T4088
Rökt med rökarom av lönn och ek.	T4088
Drivgas: xxxxxxxx	T4088
Potatismjöl är tillsatt för bibehållen finfördelning.	T4088

Ingrediensernas procentfördelning kan variera.	T4088
Till 100g färdig produkt har 130g fläskkött använts.	T4088
Kan innehålla spår av ...(allergener)	T4088
*Ekologiskt certifierad ingrediens.	T4088
*Trehalos bryts ner till glukos och fruktos.	T4088
Kakaopulver: Fairtrade-certifierad ingrediens från Fairtrade-producenter. Totalt 98 %.	T4088
KRAV -certifieringen verifierad av Kiwa.	T4088 if asterisk exists, in T3850 if there is no asterisk.
*Uppfött och slaktat i ...	T4088 if asterisk exists. If there is no asterisk, text should be entered in T4202.

Examples of texts specified in T3850 Compulsory additive label information

Text	Specified in
Innehåller ingefära – rekommenderas inte för gravida kvinnor.	T3850
Kraftigt saltad	T3850
Skinnet är inte ätbart. Avlägsnas före förtäring.	T3850
Ostens kant skall inte ätas.	T3850
Oliverna är maskinellt urkärnade. Någon kärna eller rest av kärna kan därför finnas kvar.	T3850
Hög koffeinhalt. Rekommenderas ej för barn och gravida eller ammande kvinnor (32mg Koffein/ 100mg).	T3850
Innehåller: X % fruktjuice från koncentrat och X % tillsatt socker.	T3850
Med tillsats av växtsteroler eller med tillsats av växtstanoler.	T3850
Uppgift om att artikeln inte är avsedd för personer som inte behöver kontrollera kolesterolhalten i blodet.	T3850
Uppgift om att patienter som tar kolesterolsänkande läkemedel endast bör inta varan i samråd med läkare.	T3850
Väl synlig uppgift om att livsmedlet från näringssynpunkt kan vara mindre lämpligt för gravida och ammande kvinnor samt barn under fem år.	T3850
Råd om att livsmedlet ska användas som en del av en balanserad och varierad kost som innefattar regelbundet intag av frukt och grönsaker för att upprätthålla karotennivåerna.	T3850
Uppgift om att intag av mer än 3 g per dag av tillsatta växtsteroler/växtstanoler bör undvikas.	T3850
En definition av en portion av livsmedlet eller livsmedelsingrediensen i fråga (helst i g eller ml) med uppgift om hur mycket växtsteroler/växtstanoler en portion innehåller.	T3850

Other examples of texts specified in T3850

Text	Specified in
Från x år.	T3850
Får ej sväljas.	T3850
Inte lämplig för barn under 3 år.	T3850
För barn upp till 6 år. Använd en klick tandkräm som är lika stor som en ärta.	T3850
Får inte användas av barn under x år.	T3850

Varning! Innehåller leksaker. Övervakning av vuxna rekommenderas.	T3850
Får ej användas outspädd.	T3850
Använd ej i eller nära ögonen.	T3850
Kan orsaka allergiska reaktioner, särskilt på känslig hud. Avstå från användning om du får en allergisk reaktion.	T3850
Innehåller xx g frukt per 100 g slutgiltig produkt.	T3850
Varning: Förvaras oåtkomligt för barn.	T3850
Plastpåsar är inte leksaker, dra ej påsen över huvudet.	T3850
Barn kan sätta jordnötter i halsen.	T3850
Varning – Innehåller smådelar. Inte lämplig för barn under 36 månader.	T3850
Under transport kan innehållet sjunka ihop.	T3850
Bröstmjök är bäst för barnet och rekommenderas de första 6 månaderna.	T3850
Produkterna bör förvaras utom räckhåll för små barn.	T3850
Kosttillskott bör inte användas som ett alternativ till en varierad kost och hälsosam livsstil.	T3850
En varning för att överskrida den angivna rekommenderade dagliga dosen.	T3850

Examples of texts specified in other attributes

Text	Specified in
Äkta alspånsrökt	T3746
SVENSKT MJÖL 100% mjöl från svenskodlat spannmål malt i egen kvarn	T3746
Rekommenderad daglig dos	T4070

Information for system developers and recipients of Trade Item Information

In addition to this guideline, system developers and recipients of Trade Item Information need the following documents in order to get all necessary information:

- **The Business Document Specification (BDS)**. The BDS and the Guideline must be read together.
- **The Correction documents** are valid from the time at which they are published and should be read together with the specifications.
- **GDSN Validation** comprise the global validation rules used to validate Trade Item Information in Validoo.
- **Swedish Validation rules** comprise additional local validation rules that apply for the Swedish market.

Technical documentation for Trade Item Information is found here: <https://gs1.se/en/guides/documentation/>

To search in the document press Ctrl+F.

Note that attributes are structured differently in this guideline compared to the BDS. The structure of the BDS is based on GS1's global data model, where attributes are grouped into modules, while the structure of this guideline is based on a logical grouping of attributes. The structure of this guideline is shown in the figure below.

Structure of Trade Item Information as described in this guideline

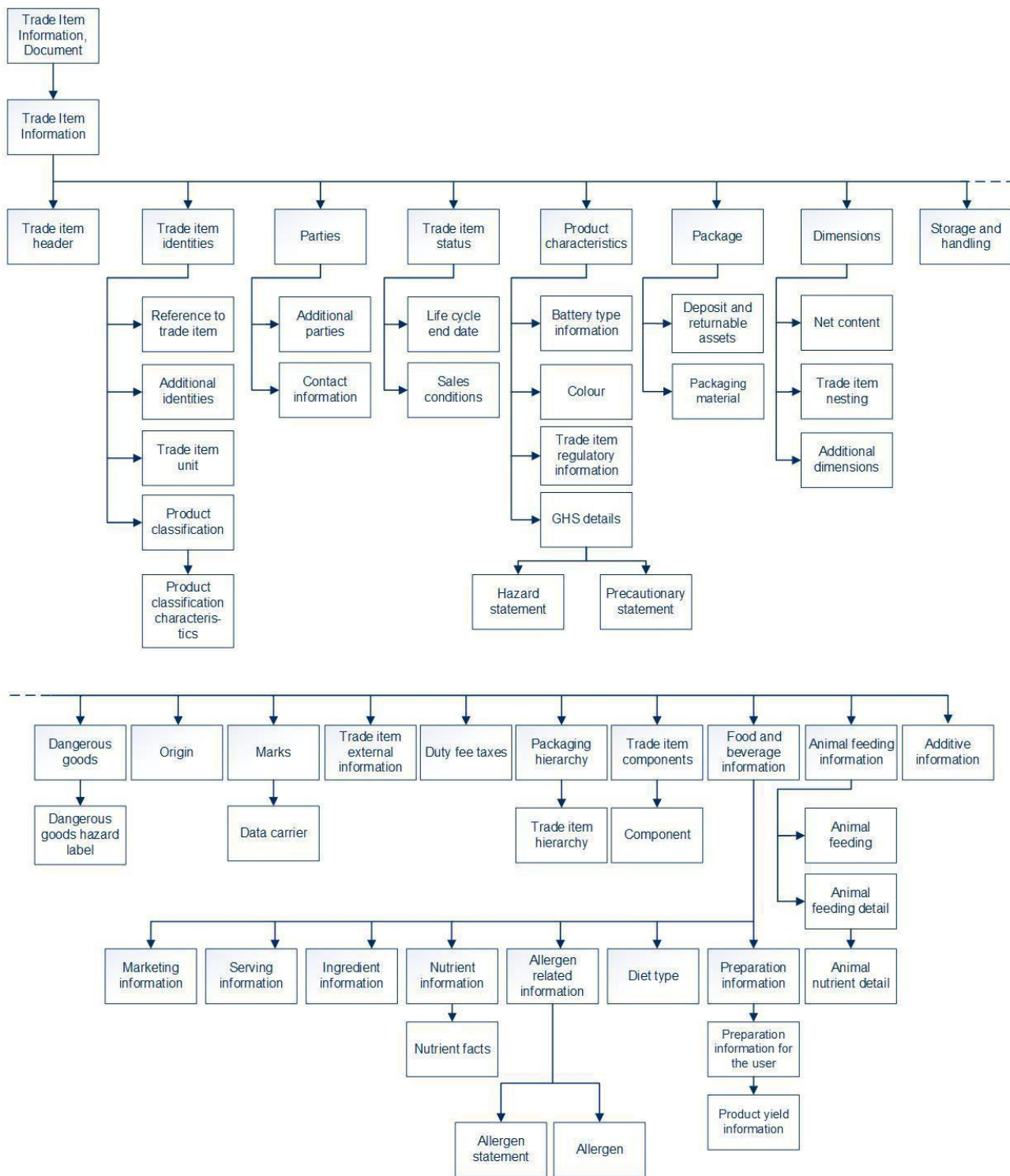

Figure 22 In this guideline, Trade Item Information is described as a series of logical groups in a hierarchical structure.