

Trade Item Information Pharmacy Guide

GDSN Release 3.1.33

GS1 Sweden

Version 1.0, 2025-09-19



Type of information	Value
Document Name	Pharmacy Guide Trade Item Information, GDSN Release 3.1.33
Document Date	2025-09-19
Document Version	1.0

Document Summary

Version	Date of change	Change made by	Change description
Trade Item Information Guideline GDSN Release 3.1.30 Version 1.0	2024-12-13	S.Petersson	<p>Correction T3789 Contact GLN</p> <p>The guide section The section "Trade Item Information to comply with fish traceability regulation" been removed and added as a separate guide.</p>
Trade Item Information Guideline GDSN Release 3.1.30 Version 1.0	2025-02-03	S.Petersson	<p>Updated description T5050 Precautionary statements description T5048 Hazard statements description</p>
Trade Item Information Guideline GDSN Release 3.1.31 Version 1.0	2025-03-14	S.Petersson	<p>New attributes T4402 Material density T4406 Target market country code T4407 Nutrient name on package T4409 Animal targeted health condition code T4410 Animal food type code</p> <p>Updated description and example T4392 Communication channel code T4393 Communication value</p> <p>Updated description T3790 Contact name T3791 Contact address T4014 Is trade item an invoice unit T0017 Is trade item an orderable unit T3337 Description short</p> <p>Updated definition T4359 Claim element code T4358 Claim type code T4018 Trade item measurements, depth T4019 Trade item measurements, height T4017 Trade item measurements, width</p> <p>Other changes T5036 Non-food ingredient statement T4088 Ingredient statement T3744 Transport category code</p> <p>The guide section The section "Animal feed" has been removed and added as a separate guide.</p>
Trade Item Information Guideline GDSN Release 3.1.32 Version 1.0			<p>Updated definition Material T4362 Size type code</p> <p>Updated description and example T3849 Import classification type code T3302 Import classification value T4360 Descriptive size dimension</p> <p>The guide section The section "Trade item levels in a trade item hierarchy" - Updated table headers</p> <p>The section "Trade Item Information for items of varying weight" - Added guidance</p>

<p>Trade Item Information Guideline GDSN Release 3.1.33 Version 1.0</p>	<p>2025-09-19</p>	<p>L. Nordin</p>	<p>New attributes T4425 Feed life stage code T4424 Animal target size code</p> <p>Updated description T4078 Allergen type code T4079 Level of containment code</p> <p>Updated example T4202 Provenance statement</p> <p>Other Changes T4212 Feeding amount T4214 Maximum feeding amount T4215 Minimum feeding amount</p>

Table of contents

Table of Contents

DESCRIPTION OF THE CONTENTS OF TRADE ITEM INFORMATION FOR THE PHARMACY INDUSTRY	9
TRADE ITEM DOCUMENT	9
T0153 Document command	9
T0151 Creation date time	10
TRADE ITEM HEADER	10
T1124 Information provider of trade item, GLN	10
T3807 Information provider of trade item, name	10
T3809 Data recipient	11
T3806 Effective date time	11
T4008 Last change date time	11
TRADE ITEM IDENTITIES	12
T0154 Trade item, GTIN	12
T0018 Functional name	12
T3810 Trade item description	13
T4800 Regulated product name	13
T0143 Brand name	14
T2230 Sub brand	14
T4344 Variant description	15
T3337 Description short	17
T4360 Descriptive size dimension	18
T3815 Context identification	19
T3849 Import classification type code	19
T3302 Import classification value	19
T4011 Target market country code	20
REFERENCE TO TRADE ITEM	20
T3793 Referenced trade item, GTIN	21
T3794 Referenced trade item type code	21
ADDITIONAL IDENTITIES	22
T3798 Additional trade item identification	22
T3799 Additional trade item identification type code	22
TRADE ITEM UNIT	23
T4010 Trade item unit descriptor code	23
T4012 Is trade item a base unit	23
PRODUCT CLASSIFICATION	24
T0280 GPC category code	24
PARTIES	24
T1115 Manufacturer of trade item, GLN	24
T3811 Manufacturer of trade item, name	26
T3750 Brand owner, GLN	26
T3752 Brand owner, name	26
CONTACT INFORMATION	27
T3789 Contact GLN	27
T3790 Contact name	27
T3791 Contact address	27
T3792 Contact type code	28
T4406 Target market country code	28
COMMUNICATION CHANNEL	28
T4392 Communication channel code	28
T4393 Communication value	29
TRADE ITEM STATUS	29
T3495 Preliminary item status code	29
T4037 Is trade item a consumer unit	30

T0017 Is trade item an orderable unit	30
T4038 Is trade item a despatch unit	30
T4014 Is trade item an invoice unit	31
T0186 Is trade item a variable unit	31
T2227 Consumer first availability date time	31
T3742 First ship date time	32
T4120 Is trade item seasonal	33
T4121 Season parameter code	33
T4727 Start availability date time	33
SALES CONDITIONS	33
T4131 Consumer sales condition code	34
LIFE CYCLE END DATE	34
T4726 End availability date time	34
T4015 Discontinued date time	35
PRODUCT CHARACTERISTICS	35
T2522 Is trade item RoHS compliant	35
T3746 Trade item marketing message	36
T4233 Short trade item marketing message	36
T4204 Trade item key words	37
T4276 Target consumer usage type code	37
T4277 Target consumer minimum usage	37
T4278 Target consumer maximum usage	38
T3775 Consumer storage instructions	39
T3776 Consumer usage instructions	39
T4306 Consumer recycling instructions	39
T5036 Non-food ingredient statement	40
T4205 Non-food ingredient name	40
T4206 Is ingredient active	41
BEAUTY PERSONAL CARE HYGIENE DETAIL	41
T4345 Formation type code	41
T4346 Time of application code	41
T4347 Skin product function or treatment code	42
T4348 Target skin type code	42
T4349 Hair product function or treatment code	42
T4350 Target hair type code	42
T4351 Natural hair colour code	43
BATTERY TYPE INFORMATION	43
T3800 Are batteries included	43
T3801 Are batteries required	43
T3802 Are batteries built in	43
T4750 Quantity of batteries built in	44
T3803 Battery technology type code	44
T3804 Battery type code	44
T3805 Quantity of batteries required	44
GHS DETAILS	45
T3745 GHS Symbol description code	45
T5044 GHS signal words code	46
HAZARD STATEMENT	46
T5047 Hazard statements code	46
T5048 Hazard statements description	47
PRECAUTIONARY STATEMENT	47
T5049 Precautionary statements code	47
T5050 Precautionary statements description	47
MATERIAL	48
T4363 Trade item material designation description	48
T4364 Material statement	48
T4365 Material code	49
T4366 Material content	49
T4367 Material percentage	49
T4368 Material thread count	49

T4369 Material weight	49
T4370 Thread denier	50
T4402 Material density	50
PACKAGE	50
T0189 Packaging terms and conditions code	50
T0137 Packaging type code	52
T2207 Is trade item a display unit	52
T4372 Packaging sustainability feature code	52
T0277 Is packaging marked returnable	53
DEPOSIT AND RETURNABLE ASSETS	53
T4149 Returnable package deposit region	53
PACKAGING MATERIAL	54
T1188 Packaging material type code	54
T1189 Packaging material composition quantity	54
T4371 Is packaging material recoverable	55
DIMENSIONS	55
T4017 Trade item measurements, width	55
T4019 Trade item measurements, height	57
T4018 Trade item measurements, depth	57
T4362 Size type code	59
T4361 Size dimension	59
T4020 Trade item gross weight	59
T0147 Price comparison measurement	60
T0145 Price comparison content type code	61
NET CONTENT	62
T0082 Net content	63
STORAGE AND HANDLING	63
T0167 Minimum trade item lifespan from time of production	64
T2521 Opened trade item lifespan	64
T4269 Item period safe to use after opening	64
T3822 Temperature qualifier code	66
T3796 Maximum temperature	66
T3797 Minimum temperature	66
T0157 Stacking factor	67
T3848 Stacking factor type code	67
DANGEROUS GOODS	68
T0263 Class of dangerous goods code	68
T3743 Dangerous goods classification code	68
T0264 Dangerous goods packing group	69
T4023 Flash point temperature	69
T4303 Net mass of explosives	69
T0169 United Nations dangerous goods number	70
T4026 Dangerous goods shipping name	70
T4027 Dangerous goods technical name	70
T4247 Dangerous goods limited quantities code	71
T4141 Hazardous material additional information	71
T4142 Dangerous goods special provisions	71
T3741 ADR tunnel restriction code	71
T3744 Transport category code	72
DANGEROUS GOODS HAZARD LABEL	72
T4143 Dangerous goods hazard label number	72
T4751 Dangerous hazardous label sequence number	72
HEALTH CARE ITEM INFORMATION	73
T4273 Does trade item contain latex	73
T4373 Prescription type code	73
ORIGIN	73
T0168 Country of origin	74
T4202 Provenance statement	74
MARKS	75
T4357 Claim marked on package	75

T4358 Claim type code	75
T4359 Claim element code	76
T4356 Claim description	76
T4032 Trade item date on packaging format type code	76
T3362 Trade item date on packaging format name	76
T3777 Packaging marked label accreditation code	77
T3850 Compulsory additive label information	78
T4272 Has batch number	78
T4281 Sun protection factor	79
DATA CARRIER	79
T4310 Data carrier type code	79
T3747 Data carrier presence code	79
DUTY FEE TAXES	80
T4033 Duty fee tax agency code	80
T0194 Duty fee tax type code	80
T0195 Duty fee tax rate	80
PACKAGING HIERARCHY	81
T4034 Quantity of children	81
T4035 Total quantity of next lower level trade item	81
TRADE ITEM HIERARCHY	82
T2045 Child trade item, GTIN	82
T3361 Quantity of next lower level trade item	82
INGREDIENT INFORMATION	83
T4088 Ingredient statement	83
NUTRITIONAL INFORMATION	84
T4069 Preparation state code	84
T4070 Daily value intake reference	85
T3820 Nutrient basis quantity type code	86
T3824 Nutrient basis quantity	86
T4399 Nutrient basis quantity description	87
NUTRIENT FACTS	87
T4076 Daily value intake percent	88
T4073 Nutrient type code	88
T4075 Measurement precision code	88
T4074 Quantity contained	88
T4407 Nutrient name on package	89
ALLERGEN INFORMATION	89
T4077 Allergen statement	89
ALLERGEN	90
T4078 Allergen type code	90
T4079 Level of containment code	91
DIET TYPE	92
T4066 Diet type code	92
T4279 Diet type subcode	92
T4312 Is diet type marked on package	92
PREPARATION INFORMATION	93
T4083 Preparation instructions	93
ATTRIBUTES RELATED TO ANIMAL FEED	93
ANIMAL FEEDING INFORMATION	93
T4222 Targeted consumption by	93
T4223 Feed type code	94
T4250 Feed additive statement	94
T4249 Feed analytical constituents statement	94
T4248 Feed composition statement	95
T4251 Feeding instructions	95
T4410 Animal food type code	95
T4409 Animal targeted health condition code	96
T4424 Animal Target Size Code	96
T4425 Feed Life Stage Code	97

ANIMAL FEEDING	97
T4208 Feed life stage	97
T4209 Maximum weight of animal being fed	97
T4210 Minimum weight of animal being fed	98
ANIMAL FEEDING DETAIL	98
T4212 Feeding amount	98
T4214 Maximum feeding amount	99
T4215 Minimum feeding amount	99
T4216 Recommended frequency of feeding	99
HOW TO FILL IN TRADE ITEM INFORMATION.....	101
SHELF-EDGE LABELS	101
Description short.....	102
Comparative price.....	102
Trade Item Information for items of varying weight.....	102
Measurement guide for selected code values in T4362 Size type code	103
Trade Item Information for books and audiobooks	104
TRADE ITEM LEVELS IN A TRADE ITEM HIERARCHY	105
DESCRIBING A TRADE ITEM HIERARCHY IN TRADE ITEM INFORMATION.....	109
CONSUMER UNIT, ORDERABLE UNIT AND/OR DESPATCH UNIT	111
SEASONAL GOODS	113
PACKAGE TYPE AND DEPOSIT FOR SVENSKA RETURSYSTEM PALLETS	113
TRADE ITEM INFORMATION TO COMPLY WITH CLP REGULATION	114
APPLICATION INSTRUCTIONS FOR COMPONENTS	116
T4088 INGREDIENT STATEMENT AND T3850 COMPULSORY ADDITIVE LABEL INFORMATION.....	118
Examples of texts specified in T4088 Ingredient statement.....	118
Examples of texts specified in T3850 Compulsory additive label information	118
Other examples of texts specified in T3850.....	119
Examples of texts specified in other attributes	119
INFORMATION FOR SYSTEM DEVELOPERS AND RECIPIENTS OF TRADE ITEM INFORMATION.....	120
STRUCTURE OF TRADE ITEM INFORMATION AS DESCRIBED IN THIS GUIDELINE	121

The pharmacy guide is a supplement to the Trade Item Information Guideline version 3.1.20 for suppliers to the pharmacy industry who uses Validoo for sharing trade item information.

[GS1 Trade Item Information » GS1 Sweden](#)

Description of the contents of Trade Item Information for the pharmacy industry

All attributes in the Trade Item Information are described here (see Trade Item Information Guideline version 3.1.20 for an explanation of the term). The attributes are grouped by area of use. For each group, there is an initial description of the area of use. An overview map of how the terms are grouped can be found in the section [Structure of Trade Item Information as described in this guideline](#).

- **Green title:** Attributes that are mandatory to enter in Validoo (see the "level" table that appears at the bottom of each attribute) and attributes that the pharmacy industry considers mandatory to enter in Validoo when it is relevant to enter trade item information for the product being registered.
- **Blue title:** Attributes that the pharmacy industry considers to be desirable but not mandatory to enter.

Trade Item Document

This group is used to specify Trade Item Information for a complete trade item hierarchy.

T0153 Document command

BMS ID	23
Definition	Code indicating if the information is an addition, a change, or a correction
Description	<p>Code indicating if the information is for a new item, changed item or corrected Trade Item Information. Note that the document command applies to the whole trade item hierarchy.</p> <p>New: Used when one or more items in the trade item hierarchy are new and are being declared for the first time. Also used when the pallet level item is new and the case and base level items are unchanged.</p> <p>Change: Used when one or more items in the hierarchy is changed, (eg a product has a new storage temperature). The change does not require the item to be given a new GTIN, according to GS1's GTIN rules.</p> <p>Correction: Used when the Trade Item Information for one or more items has been corrected. Correction means that previously missing information has been supplied, or that previously submitted information was incorrect and is now corrected, without the item itself having changed (for example, correction of a spelling mistake in the item name).</p> <p>Always choose a code in relation to previously sent information on the item that has been approved by Validoo. For example, if an attempt to register a new item is rejected by Validoo, the Trade Item Information should be corrected and resubmitted. In this case, the item is still a new item.</p> <p>Regardless of whether it is a correction or change, the recipient must handle these in their own system.</p>
Code value	Code value is specified according to code list T0153, see www.gs1.se/en-codelist-T0153 .

T0151 Creation date time

BMS ID	29
Definition	Date and point of time when the business document was created.
Description	The date and point of time when the information provider of trade item created the Trade Item Information. Times are expressed in UTC (Coordinated Universal Time), with a UTCdesignator ("Z").
Example	2020-02-18T21:51:31Z

Trade item header

This group is used to specify general information about the trade item.

Level	Component	Base	Case	Pallet
M = mandatory C = conditional - = not used	-	M	M	M

T1124 Information provider of trade item, GLN

BMS ID	83			
Definition	Identity, according to GS1's identification system, of the party who has created the business document.			
Description	The identity is a globally unique and unambiguous number. The information provider of trade item is the party who creates, changes, maintains and is responsible for the Trade Item Information. The Trade Item Information shouldn't therefore be changed by other parties.			
Level	Component	Base	Case	Pallet
M = mandatory C = conditional - = not used	-	M	M	M

T3807 Information provider of trade item, name

BMS ID	85			
Definition	Name of the party who has created the business document.			
Description	The information provider is the party who creates, changes, maintains and is responsible for the Trade Item Information. The Trade Item Information shouldn't therefore be changed by other parties.			
Level	Component	Base	Case	Pallet

M = mandatory C = conditional - = not used	-	M	M	M
---	---	---	---	---

T3809 Data recipient

BMS ID	40			
Definition	Identity, according to GS1's identification system, of the party that is authorized to view, use, download a set of Master Data provided by a Data Source.			
Description	The identity is a globally unique and unambiguous number.			
Level	Component	Base	Case	Pallet
M = mandatory C = conditional - = not used	-	M	M	M

T3806 Effective date time

BMS ID	144			
Definition	Date and point of time from which the information in this business document is effective.			
Description	<p>The date on which the Trade Item Information for this item is effective. This effective date can be used for initial trade item offering, or to mark a change in the information related to an existing trade item. This date would specify when these changes take effect.</p> <p>Times are expressed in UTC (Coordinated Universal Time), with a UTC designator ("Z").</p>			
Example	2017-12-17T15:45:00Z			
Level	Component	Base	Case	Pallet
M = mandatory C = conditional - = not used	-	M	M	M

T4008 Last change date time

BMS ID	145			
Definition	Date and point of time on which the Trade Item Information last was changed in the information provider's system.			
Description	<p>When the attribute is used it allows the data pool to control the trade item data version. The date and time is not allowed to be a date and time in the future.</p> <p>Note that the last change date time can be different date and point of times for different items in a trade item hierarchy.</p> <p>Times are expressed in UTC (Coordinated Universal Time), with a UTC designator ("Z").</p>			
Example	2017-12-17T15:45:00Z			
Level	Component	Base	Case	Pallet

M = mandatory C = conditional - = not used	-	M	M	M
--	---	---	---	---

Trade item identities

This group is used to specify information that identifies the trade item. This includes GTIN, item name, brand, shelf-edge and till-roll texts, and the hierarchical level of the trade item.

Level	Component	Base	Case	Pallet
M = mandatory C = conditional - = not used	-	M	M	M

T0154 Trade item, GTIN

BMS ID	67			
Definition	Identity of the trade item according to GS1's identification system.			
Description	<p>GTIN is a globally unique and unambiguous number. Every trade item must have a unique GTIN for ordering and statistical purposes.</p> <p>GS1 has a set of rules governing which changes on a trade item that require a new GTIN and which are permitted without the GTIN being changed. Read more about GS1's GTIN rules at www.gs1.org/gtinrules.</p>			
Level	Component	Base	Case	Pallet
M = mandatory C = conditional - = not used	-	M	M	M

T0018 Functional name

BMS ID	3508
Definition	Name of the category to which the trade item belongs.
Description	<p>Functional name must be used to clarify which product category the article belongs to. It must not contain information about, for example, T0143 Brand name, T4360 Descriptive size dimension, T4344 Variant description or T0082 Net content.</p> <p>Details should be at a fairly high level and stay within established industry categorizations whenever possible. The information provider is responsible for ensuring that the functional name is the same value across all levels in a hierarchy. It must be the same on similar items regardless of brand and product name, e.g. Eggs, Shampoo, Diapers, Chef Coat, Frying Pan.</p> <p>Exceptions are displays or gift packaging containing products with different functional names (a homogeneous display/gift packaging is specified as above, i.e. the same functional name across all levels in a hierarchy). The exception refers to the level that is the display and the overlying level, if any. In that case, these must have the same value.</p> <p>The functional name can be used for receipt text.</p> <p>If the accepted functional name contains more than one word, the main category must be entered first, for example "milk flavored".</p>

	Enter the information using the Swedish character set.			
Example	<p>Product 1: GS1 Brand Fresh Mango & Orange smoothie Eko 150ml Example of approved functional name: "Smoothie" Example of not approved functional name: "Smoothie 150ml Eko"</p> <p>Product 2: GS1 Brand Natural Hair Color Liquid Light to Medium Blonde 1 st" Example of approved functional name: "Hair Color" Example of not approved functional name: "Hair Color Medium Blonde"</p>			
Note	Allows for the representation of the same value in different languages, but not for multiple values.			
Level	Component	Base	Case	Pallet
M = mandatory C = conditional - = not used	-	M	M	M

T3810 Trade item description

BMS ID	3517			
Definition	An understandable and useable description of a trade item.			
Description	<p>Trade item description that can be understood by consumers and be used as a searchable product name. One recommendation is to use brand name, sub brand, functional name, variant, net content and, where applicable on case level, quantity of next lower level trade item. Variation of writing rules may apply depending on sector and product group.</p> <p>The attribute can be used by retailers to understand brand, taste, fragrance, etc. of a specific GTIN, and as a tool to create an appropriate product description in internal systems.</p> <p>Write as it is written on the packaging. Use as few abbreviations as possible. Always specify the information in Swedish.</p>			
Example	<p>Base: VitaTänder Exklusiv Tandkräm Mint 75 ml, ABC mjukgörande kräm 5% 500 g</p> <p>Case: VitaTänder Exklusiv Tandkräm Mint 75 ml x 4, ABC mjukgörande kräm 5% 500 g x 10</p>			
Note	Allows for the representation of the same value in different languages, but not for multiple values.			
Level	Component	Base	Case	Pallet
M = mandatory C = conditional - = not used	-	C	C	C

T4800 Regulated product name

BMS ID	3515			
Definition	The prescribed, regulated or generic product name or denomination that describes the true nature of the food and is sufficiently precise to distinguish it from other foods according to country specific regulation.			

Description	<p>The regulated product name describes the nature of the product and is precise enough to distinguish it from other foods according to the regulations of a particular country.</p> <p>The attribute is also used to indicate the trade name of the fish or aquaculture product, see the Swedish Food Agency instructions.</p> <p>Always specify the information in Swedish.</p>			
Note	Allows for the representation of the same value in different languages, but not for multiple values.			
Level	Component	Base	Case	Pallet
M = mandatory C = conditional - = not used	-	C	C	C

T0143 Brand name

BMS ID	3541			
Definition	Supplier's brand name for this item.			
Description	<p>The Brand name is used for internal use and on shelf-edge labels as information for customers.</p> <p>The supplier determines the brand and ensures that it is written in the same way for all items. In some exceptional cases, the product name is the same as the brand.</p> <p>If the trade item consists of several different trade items with different brand names, one of these should be chosen.</p> <p>Remember to be consistent with spelling, capitalization/lowercase so that the brand is described in the same way for all trade items belonging to the same brand.</p> <p>Brand name is not permitted to be changed without assigning the trade item a new GTIN (Global Trade Item Number). Read more about GS1's GTIN rules at www.gs1.org/gtinrules.</p>			
Example	"VitaTänder" is a brand for a product. Enter "VitaTänder"			
Level	Component	Base	Case	Pallet
M = mandatory C = conditional - = not used	-	M	M	M

T2230 Sub brand

BMS ID	3546			
Definition	Second level of brand.			
Description	<p>The attribute is used when there are several levels of the brand.</p> <p>The supplier determines the brand and ensures that it is written in the same way for all items. A sub-brand can be a product series or model.</p> <p>Remember to be consistent with spelling, capitalization/lowercase so that the brand is described in the same way for all trade items belonging to the same brand.</p>			
Example	"VitaTänder Exklusiv" is a brand and sub brand for a product. Enter "Exklusiv" as sub brand.			
Level	Component	Base	Case	Pallet

M = mandatory C = conditional - = not used	-	C	C	C
---	---	---	---	---

T4344 Variant description

BMS ID	3520			
Definition	Free text field used to identify the variant of the product.			
Description	<p>Variant description is a supplementary attribute to T3337 Description short. Variants are distinguishing features that distinguish products with the same T0143 Brand name and T3337 Description short and T4360 Descriptive size dimension. Variant can, for example, be the flavor of a yoghurt, the scent of a soap or the color of a sweater. The variant may appear in the product name.</p> <p>The attribute can be used to indicate supplementary information for the product and is used when there is no separate attribute for the variant. For example, there are separate attributes for the information free from, gluten-free, lactose, sun protection factor:</p> <p>T4358 Claim type code T4359 Claim element code T4281 Sun protection factor</p> <p>In cases where you specify colour as a variant, T2243 Colour description must also be filled in within the Beauty sector.</p> <p>The following writing rules apply to Variant description:</p> <ul style="list-style-type: none"> ▪ The following characters should never be used to end words in abbreviations: <ul style="list-style-type: none"> ○ Comma (,) ○ Period (.) ○ Semicolon (;) ▪ The character / is entered as a separator between similar properties, e.g. colours and flavors. Ex: White/Green, Strawberry/Wild strawberry <p>Descriptive size dimension is entered in "T4360 Descriptive size dimension".</p>			
Example	<p>Product 1: GS1 Brand Fresh Mango & Orange smoothie Eko 150ml Example of approved variant description: "Mango/orange" Example of not approved variant description: "Mango/orange 150ml"</p> <p>Product 2: GS1 Brand Fabric softener Lavender 1,8 L refill Example of approved variant description: "Lavender" Example of not approved variant description: "Lavender 1,8 L, refill"</p> <p>Product 3: GS1 Brand Socks woolmix black/white 39-42 Example of approved variant description: "Black/White" and "39-42" Example of not approved variant description: "Socks"</p>			
Level	Component	Base	Case	Pallet

<p>M = mandatory C = conditional - = not used</p>	-	C	C	C
--	---	---	---	---

T3337 Description short

BMS ID	3506
Definition	Name of the trade item, used for identification.
Description	<p>Description short can be printed on shelf edge labels and receipt text and used in e-commerce as information for consumers.</p> <p>The description short must primarily be the same text as the packaging is marked with. The attribute is 40 characters. If the text on the packaging contains more than 40 characters, the text must be abbreviated. The words should be shortened so that the text still matches the text on the packaging and so that the text cannot be misunderstood.</p> <p>The information provider is responsible for ensuring that the description short is the same across all levels in a hierarchy. Exceptions are made on displays that are homogeneous or mixed and refer to the level that is the display and the overlying level if there is one. In that case, these must have the same value. The recommendation is that the product name on display is built up using T0018 Functional name and the word "Display" or "Display Mix" at the beginning. Information about multipacks can be entered according to the writing rules below.</p> <p>In some exceptional cases, the description short is the same as the brand. T4360 Descriptive size dimension is not part of the description short. In some industry categories, information about variants such as taste, size (for example 250 ml, 15 cl, 28 Ø and S, M, L), fat content, alcohol content can be relevant information in the description short.</p> <p>The following print rules apply to shelf-edge/till-roll text and "T4360 Descriptive size dimension".</p> <ul style="list-style-type: none"> ■ The following characters must not be used at the end of abbreviated words <ul style="list-style-type: none"> • Comma (,) • Period (.) • Semicolon (;) ■ A slash (/) shall be used as a separator between similar properties such as colour or flavour, e.g. VIT/GRÖN ■ For multipacks the number in the pack should be followed by the letter "p" alternatively "pack", e.g. 4p or 4-pack ■ The number of servings provided by a product should be shown followed by PORT, e.g. 12 PORT
Example	<p>Product 1: GS1 Brand Fresh Mango & Orange smoothie Eko 150ml Example of approved description short: Smoothie Eko</p> <p>Product 2: GS1 Brand Natural Hair Color Liquid Light to Medium Blonde 1 st" Example of approved description short: Hair Color Liquid</p> <p>Product 3 (Display mix of products): GS1 Brand Fresh Mango & Orange smoothie Eko 150ml + GS1 Brand Fresh Raspberry smoothie Eko 150ml Example of approved description short: Display Mix Smoothie Eko</p>
Note	Allows for the representation of the same value in different languages, but not for multiple values.

Level	Component	Base	Case	Pallet
M = mandatory C = conditional - = not used	-	M	M	M

T4360 Descriptive size dimension

BMS ID	7218			
Definition	Text indicating article size.			
Description	<p>The attribute is used for specifying a size intended for identifying the item, e.g. 500 g, 1200 W, 1,5 l. The information is used internally and on shelf-edge labels and to receipts as information for consumers. The information is usually on the front of the package.</p> <p>This attribute is mandatory if the trade item is a consumer unit with a barcode, and if it is intended for retail sale. Certain types of items, for example small cosmetic trade items, are excluded from the rule.</p> <p>Always specify the information in Swedish.</p> <p>See print rules for "T3337 Description short".</p> <p>The value is limited to 8 characters according to Swedish application.</p> <p>If both the net content and the number of pieces are written on the front of the package, it is recommended to enter the number of pieces in "T4360 Descriptive size dimension" and net content in "T0082 Net content". The attribute "T4305 Net content statement" is also an option to describe size/quantity in the package.</p>			
Example	<p>Example 1: Cookies - front of package labeled 7 pcs, 170g. "T4360 Descriptive size dimension": 7 pcs "T0082 Net content": 170g</p> <p>Example 2: Multipack soft drink – front of package labeled 10x330ml "T4360 Descriptive size dimension": 10x330ml "T0082 Net content": 3.3L</p> <p>Example 3: Chicken fillets - front of package labeled 4 pcs, approx. 150g/pcs, 600g. "T4360 Descriptive size dimension": 4 pcs "T0082 Net content": 600g "T4305 Net content statement": approx. 150g/fillet</p> <p>Example 4: For food preserved in liquid, total weight should be specified in "T4360 Descriptive size dimension". To specify weight excluding liquid, so-called drained weight, use the following attributes together: "T0145 Price comparison content type code": DRAINED_WEIGHT – By drained weight "T0147 Price comparison measurement"</p>			
Note	Allows for the representation of the same value in different languages, but not for multiple values.			
Level	Component	Base	Case	Pallet
M = mandatory C = conditional - = not used	-	C	C	-

T3815 Context identification

BMS ID	55			
Definition	The unique identifier established for the context managed by GS1.			
Description	For a single trade item, different sets of modules may be required depending on how the trade item is used. The attribute controls the validation depending on the product group specified.			
Code value	Code value is specified according to code list T3815, see www.gs1.se/en-codelist-T3815 .			
Level	Component	Base	Case	Pallet
M = mandatory C = conditional - = not used	C	C	C	C

T3849 Import classification type code

BMS ID	2776			
Definition	Imports and exports of trade items typically require classification codes to determine appropriate duties and tariffs.			
Description	<p>Classification codes have several different uses, for example:</p> <ul style="list-style-type: none"> when importing and exporting trade items to determine which customs duties and tariffs should be applied. as statistical commodity code for intrastat reporting. to identify whether the product is subject to legislation. <p>This attribute should be used together with "T3302 Import classification value".</p>			
Example	<p>The specified code in "T3849 Import classification type code" affects the number of digits that must be entered in "T3302 Import classification value".</p> <p>Example 1: "T3849 Import classification type code": INTRASTAT – INTRASTAT "T3302 Import classification value": 09012100</p> <p>Example 2: "T3849 Import classification type code": _TARIF_INTEGRE_DE_LA_COMMUNAUTE – Integrerad tariff för Europeiska unionen (TARIC) "T3302 Import classification value": 0901210000</p>			
Code Value	Code value is specified according to code list T3849, see www.gs1.se/en-codelist-T3849 .			
Level	Component	Base	Case	Pallet
M = mandatory C = conditional - = not used	-	C	-	-

T3302 Import classification value

BMS ID	2777			
Definition	Customs product code.			

Description	<p>The code is specified according to the type of classification stated in "T3849 Import classification type code".</p> <p>This attribute should be used together with "T3849 Import classification type code".</p>			
Example	<p>The specified code in "T3849 Import classification type code" affects the number of digits that must be entered in "T3302 Import classification value".</p> <p>Example 1: "T3849 Import classification type code": INTRASTAT – INTRASTAT "T3302 Import classification value": 09012100</p> <p>Example 2: "T3849 Import classification type code": _TARIF_INTEGRE_DE_LA_COMMUNAUTE – Integrerad tariff för Europeiska unionen (TARIC) "T3302 Import classification value": 0901210000</p>			
Code Value	Choose code values from external code list, see www.tullverket.se .			
Level	Component	Base	Case	Pallet
M = mandatory C = conditional - = not used	-	C	-	-

T4011 Target market country code

BMS ID	112			
Definition	Code indicating the country level or higher geographical definition in which the information provider will make the trade item available to buyers.			
Description	<p>The target market country does not in any way govern where the buyer may resell the trade item to consumers.</p> <p>The attribute must be used once per item. If the item is intended for more than one target market item information must be sent once per target market.</p>			
Code value	<p>Code value is specified according to code list T3783, see www.gs1.se/en-codelist-T3783.</p> <p>Code is specified according to ISO 3166-1 (three digit numeric).</p>			
Level	Component	Base	Case	Pallet
M = mandatory C = conditional - = not used	-	M	M	M

Reference to trade item

This group refers to trade item, not in the trade item hierarchy, that is referenced for a specific purpose for example substitute, replaced, equivalent trade items.

Level	Component	Base	Case	Pallet
M = mandatory C = conditional - = not used	-	C	C	-

T3793 Referenced trade item, GTIN

BMS ID	116			
Definition	The identification of the referenced trade item, GTIN.			
Description	<p>The identity is a globally unique and unambiguous number.</p> <p>The attribute is used to identify a trade item that is related to this trade item in one way or another. The reference is specified by stating the type of relationship in question and the GTIN in question.</p> <p>The attribute can also be used to indicate that this trade item has replaced another trade item. Specify the discontinued GTIN that has replaced this trade item.</p> <p>It can also be used when the trade item is a variant of a previously specified trade item in the buyer's line. Example: A new flavor of an existing soft drink.</p> <p>The attribute may be used when the trade item has identical package type, physical dimensions and brand name as the item variant master trade item. This attribute only creates a logical link to a similar product. All Trade Item Information for the item must still be sent.</p> <p>Another name for the new item, which is a variant of the item variant master, is "line extension".</p> <p>Enter the current GTIN and then select the type of article that is referred to by selecting the type in the code list T3794.</p>			
Level	Component	Base	Case	Pallet
M = mandatory C = conditional - = not used	-	M	M	-

T3794 Referenced trade item type code

BMS ID	115			
Definition	A code depicting the type of trade item that is referenced for a specific purpose.			
Description	The code describes the relationship trade items have to each other. Referenced trade item type code can, for example, be replaced and item variant master.			
Code value	Code value is specified according to code list T3794, see www.gs1.se/en-codelist-T3794 .			
Level	Component	Base	Case	Pallet
M = mandatory C = conditional - = not used	-	M	M	-

Additional Identities

This group refers to other alternatives to the Global Trade Item Number to identify a trade item.

Level	Component	Base	Case	Pallet
M = mandatory C = conditional - = not used	-	C	C	C

T3798 Additional trade item identification

BMS ID	68			
Definition	An identification depicting the type of trade item that is referenced for a specific purpose.			
Description	<p>This term must always be used together with "T3799 Additional trade item identification type code", meaning that if T3799 is used then T3798 must also be used.</p> <p>In Swedish implementation, an additional trade item identification cannot exceed 14 characters.</p> <p>In the pharmacy industry, the base level can be orderable. All levels in the trade item hierarchy must have different identities.</p>			
Note	Note that the information in the attribute may vary depending on the recipient.			
Level	Component	Base	Case	Pallet
M = mandatory C = conditional - = not used	-	M	M	M

T3799 Additional trade item identification type code

BMS ID	69			
Definition	Code specifying an additional trade item identification type.			
Description	<p>Use this attribute together with "T3798 Additional trade item identification" to provide a supplemental identification for the trade item. This term must always be used together with "T3798 Additional trade item identification", meaning that if T3798 is used then T3799 must also be used.</p> <p>Code value SUPPLIER_ASSIGNED is mandatory for orderable trade items for all recipients in the pharmacy industry.</p>			
Example	To provide a supplier's trade item number, choose code "SUPPLIER_ASSIGNED" and enter the supplier's trade item number in "T3798 Additional trade item identification".			
Code values	Code value is specified according to code list T3799, see www.gs1.se/en-codelist-T3799 .			
Note	Note that the information in the attribute may vary depending on the recipient.			
Level	Component	Base	Case	Pallet

M = mandatory C = conditional - = not used	-	M	M	M
--	---	---	---	---

Trade item unit

This group of attributes is used to specify the hierarchical level of the trade item. Read more about trade item levels in chapter [Trade item levels in a trade item hierarchy](#).

Level	Component	Base	Case	Pallet
M = mandatory C = conditional - = not used	-	M	M	M

T4010 Trade item unit descriptor code

BMS ID	66			
Definition	Code indicating the hierarchical level of the trade item.			
Description	<p>This information is intended for the recipients as comprehensive information. However, there are no rules for other attributes that are based on these code values.</p> <p>Read more about trade item levels in chapter Trade item levels in a trade item hierarchy.</p>			
Example	<p>Examples of trade item levels:</p> <ul style="list-style-type: none"> • If the trade item hierarchy only has one level, that level is the base unit level. • If the trade item hierarchy has two levels, it is comprised of a trade item at base unit level and a trade item at pallet level, even if the highest level is not a pallet or similar. Example: Bottles in a box or carton. • If the trade item hierarchy has three or more levels, it is comprised of a trade item at base unit level, a trade item at pallet level and one or more trade items at case level. Example: A multi-pack packaged in boxes and sold on a full-size pallet. 			
Code value	Code value is specified according to code list T4010, see www.gs1.se/en-codelist-T4010 .			
Level	Component	Base	Case	Pallet
M = mandatory C = conditional - = not used	-	M	M	M

T4012 Is trade item a base unit

BMS ID	56
Definition	Is trade item a base unit
Description	<p>A trade item at base unit level contains no other items identified with a GTIN (Global Trade Item Number).</p> <p>Read more about trade item levels in chapter Trade item levels in a trade item hierarchy</p>

Code value	true - base unit false - not a base unit			
Level	Component	Base	Case	Pallet
M = mandatory C = conditional - = not used		M	M	M

Product classification

This group is used to specify the classification category and product classification characteristics according to GPC (GS1 Global Product Classification). For more information on using GPC, see www.gs1.se/gpc.

Level	Component	Base	Case	Pallet
M = mandatory C = conditional - = not used	M	M	M	M

T0280 GPC category code

BMS ID	161			
Definition	Code indicating the classification category (brick code) for the trade item according to GPC.			
Description	<p>The attribute should always be specified once per item on all item levels. If a trade item consists of child trade items belonging to different product classes, use the most significant product class.</p> <p>For dietary supplements, select the appropriate GPC code in Segment 51000000 Healthcare. It is needed to enable entering certain types of dietary supplement information, such as being able to enter information per piece.</p>			
Example	10000455 (= Diagnostic monitors for home use) 10000673 (= Healthcare - mixed packaging) 10000468 (= Nutritional supplements)			
Level	Component	Base	Case	Pallet
M = mandatory C = conditional - = not used	M	M	M	M

Parties

This group refer to the identification of a party, by GLN and name in a specific party role and to different contacts by GLN, name and address in a business relation.

Level	Component	Base	Case	Pallet
M = mandatory C = conditional - = not used	-	C	C	C

T1115 Manufacturer of trade item, GLN

BMS ID	91
Definition	Identity, according to GS1's identification system, of the party who is the manufacturer of the products.

Description	Specify the GLN for the producer who manufactures the trade item			
Level	Component	Base	Case	Pallet
M = mandatory C = conditional - = not used	-	C	C	C

T3811 Manufacturer of trade item, name

BMS ID	93			
Definition	Name of the party who is the manufacturer of the product.			
Description	The attribute is only used, and must be used, when "T1115 Manufacturer identification, GLN" is used.			
Level	Component	Base	Case	Pallet
M = mandatory C = conditional - = not used	-	C	C	C

T3750 Brand owner, GLN

BMS ID	75			
Definition	Identity of the brand owner according to GS1's identification system.			
Description	The Brand owner may or may not be the same entity as the information provider. The attribute must be used when the buyer owns the brand.			
Level	Component	Base	Case	Pallet
M = mandatory C = conditional - = not used	-	C	C	C

T3752 Brand owner, name

BMS ID	77			
Definition	Name of the party who owns the brand of the trade item.			
Description	The attribute is only used, and must be used, when "T3750 Brand owner" is used.			
Level	Component	Base	Case	Pallet
M = mandatory C = conditional - = not used	-	C	C	C

Contact Information

This group of attributes refer to contact details for a trade item. This group can be repeated with the attributes T3789, T3790, T3791 and T3792 in combination. Choose a contact type code first in T3792 and then enter either T3789 or T3790 or T3791 or in combination.

Level	Component	Base	Case	Pallet
M = mandatory C = conditional - = not used	-	C	C	-

T3789 Contact GLN

BMS ID	128			
Definition	Identity of the party, according to GS1's identification system. The GLN is the primary contact identifier. Each contact identified in the trading relationship must have a primary contact Identification.			
Description	This identity is a GLN. Any contact identified in this field must have a GLN.			
Example	Example: Customer contact. Use code CYC customer support in T3792 and then enter GLN in T3789.			
Level	Component	Base	Case	Pallet
M = mandatory C = conditional - = not used	-	C	C	-

T3790 Contact name

BMS ID	126			
Definition	The name of the company or person associated with the contact type.			
Description	Read more about how the attribute is used in the separate Trade Item Information GPSR Guide .			
Example	For example, in case of a contact type of consumer support, this could be the company name as expressed on the trade item packaging or label. Choose code CXC in "T3792 Contact type code" and then enter the name in "T3790 Contact name" and contact address in "T3791 Contact address".			
Level	Component	Base	Case	Pallet
M = mandatory C = conditional - = not used	-	C	C	-

T3791 Contact address

BMS ID	123			
Definition	The address associated with the contact type.			
Description	Read more about how the attribute is used in the separate Trade Item Information GPSR Guide .			

Example	For example, in case of a contact type of consumer support, this could be the full company address as expressed on the trade item packaging or label. Choose code CXC in "T3792 Contact type code" and then enter the name in "T3790" and contact address in "T3791 Contact address".			
Level	Component	Base	Case	Pallet
M = mandatory C = conditional - = not used	-	C	C	-

T3792 Contact type code

BMS ID	127			
Definition	The general category of the contact party for a trade item.			
Description	Read more about how the attribute is used in the separate Trade Item Information GPSR Guide .			
Code value	Code value is specified according to code list T3792, see www.gs1.se/en-codelist-T3792 .			
Level	Component	Base	Case	Pallet
M = mandatory C = conditional - = not used	-	M	M	-

T4406 Target market country code

BMS ID	138			
Definition	The target market code indicates the country level or higher geographical definition in which the contact information is applicable.			
Description	Read more about how the attribute is used in the separate Trade Item Information GPSR Guide .			
Code value	Code value is specified according to code list T3783 Target market country code . Code is specified according to ISO 3166-1 (three digit numeric).			
Level	Component	Base	Case	Pallet
M = mandatory C = conditional - = not used	-	C	C	-

Communication channel

The group is used for specifying the channel or manner in which a communication can be made, such as telephone or email.

T4392 Communication channel code

BMS ID	134			
Definition	Code specifying the type of communication channel.			
Description	Read more about how the attribute is used in the separate Trade Item Information GPSR Guide .			

	This attribute should be used together with "T4393 Communication value".			
Example	To enter the email address, enter the code value EMAIL in "T4392 Communication channel code" and the e-mail address in "T4393 Communication value".			
Code Value	Code value is specified according to code list T4392, see www.gs1.se/en-codelist-T4392 .			
Level	Component	Base	Case	Pallet
M = mandatory C = conditional - = not used	-	C	C	-

T4393 Communication value

BMS ID	135			
Definition	Text identifying the endpoint for the communication channel.			
Description	Read more about how the attribute is used in the separate Trade Item Information GPSR Guide . This attribute should be used together with "T4392 Communication channel code".			
Example	To enter the email address, enter the code value EMAIL in "T4392 Communication channel code" and the e-mail address in "T4393 Communication value".			
Level	Component	Base	Case	Pallet
M = mandatory C = conditional - = not used	-	C	C	-

Trade item status

This group of attributes is used to specify information about the trade item status, for example if the item is intended for ultimate consumption, if it is a despatch unit, and if and when it is orderable.

Level	Component	Base	Case	Pallet
M = mandatory C = conditional - = not used		M	M	M

T3495 Preliminary item status code

BMS ID	64			
Definition	A code designating whether the trade item has data that the information provider intends to correct or add values to due to pre-production unknowns (PRELIMINARY) or whether the item has attribute values that reflect go to market state (FINAL).			

Description	<p>The attribute is used to indicate whether the Trade Item Information is an announcement according to the ECR.</p> <p>If the attribute is entered with code PRELIMINARY, the attribute must be entered with code FINAL for the final version of Trade Item Information.</p> <p>If no code value is specified then the information is "Final" Trade Item Information.</p>			
Code value	Code value is specified according to code list T3495, see www.gs1.se/en-codelist-T3495 .			
Level	Component	Base	Case	Pallet
M = mandatory C = conditional - = not used	-	C	C	C

T4037 Is trade item a consumer unit

BMS ID	57			
Definition	Code indicating whether the trade item is intended for ultimate consumption.			
Code value	true - consumer unit false - not consumer unit			
Level	Component	Base	Case	Pallet
M = mandatory C = conditional - = not used	-	M	M	M

T0017 Is trade item an orderable unit

BMS ID	60			
Definition	Code indicating whether the trade item is orderable.			
Description	Orderable unit indicates whether the buyer can order this item from the supplier or not. In most cases the orderable trade item is the same as the invoice trade item, but it does not have to be.			
Code value	true - orderable false - not orderable			
Note	Note that the information in the attribute may vary depending on the recipient.			
Level	Component	Base	Case	Pallet
M = mandatory C = conditional - = not used	-	M	M	M

T4038 Is trade item a despatch unit

BMS ID	58			
Definition	Code indicating whether the trade item can be a despatch unit.			
Code value	true - despatch unit false - not despatch unit			
Note	Note that the information in the attribute may vary depending on the recipient.			
Level	Component	Base	Case	Pallet
M = mandatory C = conditional - = not used	-	M	M	M

T4014 Is trade item an invoice unit

BMS ID	59			
Definition	Code indicating whether the trade item will be specified on the billing or invoice.			
Description	The invoice trade item is the same as an orderable trade item in most cases, but it does not have to be.			
Code value	true - invoice unit false - not invoice unit			
Note	Note that the information in the attribute may vary depending on the recipient.			
Level	Component	Base	Case	Pallet
M = mandatory C = conditional - = not used	-	M	M	M

T0186 Is trade item a variable unit

BMS ID	3908			
Definition	Code indicating whether this is a variable measure item, that is, the quantity in the package is not fixed, and the price for the item varies with the quantity.			
Code value	true - variable measure item false - not variable measure item			
Level	Component	Base	Case	Pallet
M = mandatory C = conditional - = not used	-	M	M	M

T2227 Consumer first availability date time

BMS ID	1001			
Definition	The first date and point of time at which a trade item is allowed to be sold to consumers.			

Description	Times are expressed in UTC (Coordinated Universal Time), with a UTC designator ("Z").			
Example	2017-09-13T10:46:13Z			
Note	Note that the information in the attribute may vary depending on the recipient.			
Level	Component	Base	Case	Pallet
M = mandatory C = conditional - = not used	-	C	C	C

T3742 First ship date time

BMS ID	1008			
Definition	The earliest date and point of time that the trade item can be shipped according to the delivery terms, independent of any specific ship-from location.			
Description	Times are expressed in UTC (Coordinated Universal Time), with a UTC designator ("Z").			
Example	2017-10-01T13:35:14Z			
Level	Component	Base	Case	Pallet
M = mandatory C = conditional - = not used	-	C	C	C

T4120 Is trade item seasonal

BMS ID	1550			
Definition	Code indicating whether the trade item is only offered during certain parts of the year or targeted to different seasons.			
Code value	true - trade item is seasonal			
	false - trade item is not seasonal			
Level	Component	Base	Case	Pallet
M = mandatory C = conditional - = not used	-	C	C	C

T4121 Season parameter code

BMS ID	1556			
Definition	Code indicating the season the trade item is offered during or targeted for.			
Description	This attribute can be used if the trade item is seasonal, that is if the code value for "T4120 Is trade item seasonal" is "true".			
Code value	Code value is specified according to code list T4121, see www.gs1.se/en-codelist-T4121 .			
Level	Component	Base	Case	Pallet
M = mandatory C = conditional - = not used	-	C	C	C

T4727 Start availability date time

BMS ID	1025			
Definition	Date and point of time from when the item is available.			
Description	<p>For an orderable item the Start availability date time specifies the date and point of time from when an item will be available for ordering.</p> <p>The attribute should not be mixed-up with the launch date, which can be specified in "T2227 Consumer availability date time".</p> <p>Times are expressed in UTC (Coordinated Universal Time), with a UTC designator ("Z").</p>			
Example	2016-06-22T12:00:00Z			
Note	Note that the information in the attribute may vary depending on the recipient.			
Level	Component	Base	Case	Pallet
M = mandatory C = conditional - = not used	-	M	M	M

This group of attributes can be used to specify sales conditions for the trade item.

Level	Component	Base	Case	Pallet
M = mandatory C = conditional - = not used	-	C	C	C

T4131 Consumer sales condition code

BMS ID	3325			
Definition	Code indicating restrictions imposed on the trade item regarding how it can be sold to the consumer.			
Description	A restriction can for example be that a prescription is needed, or that there is an age limit for purchasing the product.			
Code value	Code value is specified according to code list T4131, see www.gs1.se/en-codelist-T4131 .			
Level	Component	Base	Case	Pallet
M = mandatory C = conditional - = not used	-	C	C	C

Life cycle end date

This group of attributes can be used to specify the date and point of time from which promotion and seasonal items no longer can be ordered, or the date on which a discontinued item is no longer available to the buyer.

Level	Component	Base	Case	Pallet
M = mandatory C = conditional - = not used	-	C	C	C

T4726 End availability date time

BMS ID	1002			
Definition	The date and point of time from which an orderable trade item no longer can be ordered.			
Description	<p>The attribute can for example be used for promotions and seasonal items. The attribute is also used to notify selected recipients that the trade item will be discontinued. The attribute should not be used for trade items that are discontinued for all recipients. In those cases, "T4015 Discontinued date time" should be used.</p> <p>The attribute shall also be specified for other items in the hierarchy which will cease to be delivered when the orderable item is no longer available.</p>			
	<p>Times are expressed in UTC (Coordinated Universal Time), with a UTC designator ("Z").</p> <p>Read more about how this attribute is used for seasonal items in section Seasonal goods.</p>			

Example	2017-04-31T12:00:00Z An item hierarchy consists of: <ul style="list-style-type: none"> ■ Base unit: Bottle of shampoo. ■ Case level: Case of bottles of shampoo (orderable item). ■ Pallet level: Pallet of cases of bottles of shampoo. The last date for ordering a case is 2017-04-31. Consequently, the pallet of cases will cease to be delivered on the same date. End availability date time must therefore be specified for both the case and pallet. The base unit, a bottle of shampoo, is part of another hierarchy and can still be delivered. Therefore, End availability date time shall not be specified for the bottle.			
Note	Note that the information in the attribute may vary depending on the recipient.			
Level	Component	Base	Case	Pallet
M = mandatory C = conditional - = not used	-	C	C	C

T4015 Discontinued date time

BMS ID	143			
Definition	The date and time on which the trade item is no longer available to the buyer.			
Description	The attribute is mandatory for trade items that are discontinued for all recipients. For trade items that are discontinued for selected recipients, "T4726 End availability date time" should be used instead. Times are expressed in UTC (Coordinated Universal Time), with a UTC designator ("Z").			
Example	2017-03-15T12:00:00Z			
Level	Component	Base	Case	Pallet
M = mandatory C = conditional - = not used	-	C	C	C

Product characteristics

This group of attributes can be used to specify information about various product characteristics.

Level	Component	Base	Case	Pallet
M = mandatory C = conditional - = not used	-	C	C	C

T2522 Is trade item RoHS compliant

BMS ID	2518
Definition	Code indicating whether the product is compliant with the European Union RoHS Directive.

Description	RoHS restricts the use of certain hazardous substances in electrical and electronic equipment. The RoHS bans the placing on the EU market of new electrical and electronic equipment containing more than agreed levels of lead, cadmium, mercury, hexavalent chromium, polybrominated biphenyl (PBB) and polybrominated diphenyl ether (PBDE) flame retardants.			
Code value	true - trade item complies to RoHS directive false - trade item does not comply to RoHS directive			
Level	Component	Base	Case	Pallet
M = mandatory C = conditional - = not used	-	C	-	-

T3746 Trade item marketing message

BMS ID	1498			
Definition	Marketing message associated with the trade item.			
Description	Used to specify a marketing message for the trade item. Suppliers are responsible for ensuring that marketing messages comply with applicable laws and regulations for the product and that the text can be used for the end customer/consumer. Always specify the information in Swedish.			
Note	"T3746 Trade item marketing message" can be repeated with different content and in different languages with the desired sequence, ie in the order in which the sender wants to display the marketing message. For each repetition, enter a number in the attribute "T4234 Sequence number" (See BDS), for example in the order you want to display the marketing messages.			
Level	Component	Base	Case	Pallet
M = mandatory C = conditional - = not used	-	C	C	-

T4233 Short trade item marketing message

BMS ID	1525			
Definition	A short marketing message associated with the trade item Suppliers are responsible for ensuring that marketing messages comply with applicable laws and regulations for the product and that the text can be used for the end customer/consumer.			
Description	The term can be used to create short marketing messages in a bullet list. Specify the information in Swedish.			
Note	"T4233 Short trade item marketing message" can be repeated with different content and in different languages with the desired sequence, ie in the order in which the sender wants to display the marketing message. For each repetition, enter a number in the attribute "T4234 Sequence number" (See BDS), for example in the order you want to display the marketing messages.			
Level	Component	Base	Case	Pallet

M = mandatory C = conditional - = not used	-	C	C	-
---	---	---	---	---

T4204 Trade item key words

BMS ID	1530			
Definition	Words or phrases that enables web search engines to find trade items on the internet			
Description	<p>Words or phrases that the consumer may use to search for products online.</p> <p>Use commas to separate search terms, without adding any spaces between individual terms.</p> <p>Search terms should be used to find the company's products. It is not permitted to use search terms to include/link other brands and/or products, e.g. by writing another company's brand names and/or product names on their own products' search terms.</p>			
Example	<p>Product: Läppbalsam</p> <p>"läppbalsam,läppsvalva,salva,torra läppar,känsliga läppar,spruckna läppar,parfymfri,fet salva"</p>			
Level	Component	Base	Case	Pallet
M = mandatory C = conditional - = not used	-	C	C	-

T4276 Target consumer usage type code

BMS ID	6174			
Definition	A code identifying the type of usage criteria for the target consumer that will use the product			
Description	<p>Use with T4277 Target consumer minimum usage criteria and/or T4278 Target consumer maximum usage criteria to describe a property of the consumer for which the product is intended.</p> <p>Provide the target consumer criteria using T4276 and provide in T4277 and/or T4288 the lowest and highest value associated with the criteria.</p>			
Example	Age Height Weight			
Code Value	Provide a code value from code list T4276, see www.gs1.se/en-codelist-t4276			
Level	Component	Base	Case	Pallet
M = mandatory C = conditional - = not used	-	C	C	-

T4277 Target consumer minimum usage

BMS ID	6170			
Definition	Measurement of the minimum usage criteria for the target consumer that will use the product			

Description	<p>Use with T4276 Target consumer usage type code.</p> <p>Provide in T4277 the lowest value associated with the target consumer usage type that you have chosen in T4276.</p> <p>This attribute requires a unit of measure specific to the target consumer usage type chosen in T4276, see "Code Value" section below for examples.</p>			
Example	170 cm			
Code Value	<p>Provide a code value from code list T3780 Measurement unit code, see www.gs1.se/en-codelist-t3780.</p> <p>For age in "T4276 Target consumer usage type code" choose code value: ANN – Year.</p> <p>For height in "T4276 Target consumer usage type code" choose code value: CMT – Centimeter.</p> <p>For weight in "T4276 Target consumer usage type code" choose code value: KGM – Kilogram.</p>			
Level	Component	Base	Case	Pallet
M = mandatory C = conditional - = not used	-	C	C	-

T4278 Target consumer maximum usage

BMS ID	6172			
Definition	Measurement of the maximum usage criteria for the target consumer that will use the product			
Description	<p>Use with T4276 Target consumer usage type code.</p> <p>Provide in T4278 the highest value associated with the target consumer usage type that you have chosen in T4276.</p> <p>This attribute requires a unit of measure specific to the target consumer usage type chosen in T4276, see "Code Value" section below for examples.</p>			
Example	190 cm			
Code Value	<p>Provide a code value from code list T3780 Measurement unit code, see www.gs1.se/en-codelist-t3780.</p> <p>For age in "T4276 Target consumer usage type code" choose code value: ANN – Year.</p> <p>For height in "T4276 Target consumer usage type code" choose code value: CMT – Centimeter.</p> <p>For weight in "T4276 Target consumer usage type code" choose code value: KGM – Kilogram.</p>			
Level	Component	Base	Case	Pallet
M = mandatory C = conditional - = not used	-	C	C	-

T3775 Consumer storage instructions

BMS ID	789			
Definition	Expresses in text the consumer storage instructions of a product which are normally held on the label or accompanying the product. This information may or may not be labeled on the pack.			
Description	<p>Instructions may refer to a suggested storage temperature, a specific storage requirement.</p> <p>Always specify the information in Swedish.</p>			
Example	<p>"Förvara i kylskåp efter öppning"</p> <p>"Utsätt ej för direkt solljus"</p>			
Note	Allows for the representation of the same value in different languages, but not for multiple values.			
Level	Component	Base	Case	Pallet
M = mandatory C = conditional - = not used	-	C	C	C

T3776 Consumer usage instructions

BMS ID	791			
Definition	Expresses in text the consumer usage instructions of a product which are normally held on the label or accompanying the product. This information may or may not be labeled on the pack.			
Description	<p>Instructions may refer to how the consumer is to use the product. This does not include storage, food preparations, and drug dosage and preparation instructions.</p> <p>Suppliers are responsible for ensuring that user instructions for consumers comply with current requirements and regulations for the product and that the text can be used for the end customer/consumer.</p> <p>Always specify the information in Swedish.</p>			
Example	<p>"Konsumera inom 4 dagar"</p> <p>"Applicera först foundation längs ansiktets mitt. Använd bara en liten mängd foundation och massera in ordentligt i huden."</p>			
Note	Allows for the representation of the same value in different languages, but not for multiple values.			
Level	Component	Base	Case	Pallet
M = mandatory C = conditional - = not used	-	C	C	C

T4306 Consumer recycling instructions

BMS ID	6300			
Definition	Expresses in text the consumer recycling instructions.			

Description	Instructions are normally on the label or accompany the product. They may refer to how the consumer is supposed to sort the product and packaging materials for recycling.			
Example	"Sortera som plast" "Sortera kork och topp som plast och resten av förpackningen som papper"			
Note	Allows for the representation of the same value in different languages, but not for multiple values.			
Level	Component	Base	Case	Pallet
M = mandatory C = conditional - = not used	-	C	C	C

T5036 Non-food ingredient statement

BMS ID	1623			
Definition	Information on the constituent non-food ingredient make-up of the product specified as one string.			
Description	The attribute is used to specify the ingredients printed on the package. If the ingredients are specified for a non-food item and the item is intended to be sold in Sweden then the information must follow relevant Swedish legislation and rules. Specify the information in Swedish.			
Note	If there is a short and a long ingredient statement on the package, both must be specified in the Trade Item Information. The attribute is applicable to non-food. For food, use "T4088 Ingredient statement". For animal feed, use "T4248 Feed composition statement". May be repeated with different content and in different languages.			
Level	Component	Base	Case	Pallet
M = mandatory C = conditional - = not used	C	C	-	-

T4205 Non-food ingredient name

BMS ID	1635			
Definition	The name of the non-food ingredient.			
Description	Can be used in combination with the T4206 "Is active ingredient".			
Example	Acetylsalicylic acid			
Note	Allows for the representation of the same value in different languages.			
Level	Component	Base	Case	Pallet
M = mandatory C = conditional - = not used	-	C	C	-

T4206 Is ingredient active

BMS ID	1633			
Definition	Determines whether the ingredient helps directly in achieving the objectives of the trade item.			
Description	Active substance is the substance of a drug, herbal or other product that gives its medical effect.			
Example	A product can have several active substances, such as "aspirin containing acetylsalicylic acid and caffeine".			
Code Value	true - the ingredient is active false - the ingredient is not active			
Level	Component	Base	Case	Pallet
M = mandatory C = conditional - = not used	-	C	C	-

Beauty personal care hygiene detail

The group of attributes is used to provide information on beauty, personal care and hygiene details.

Level	Component	Base	Case	Pallet
M = mandatory C = conditional - = not used	-	C	C	-

T4345 Formation type code

BMS ID	6528			
Definition	The state in which the product is sold.			
Example	Lotion, Mousse, Powder, Gel, Liquid			
Code value	Code value is specified according to codelist T4345, see www.gs1.se/en-codelist-T4345			
Level	Component	Base	Case	Pallet
M = mandatory C = conditional - = not used	-	C	C	-

T4346 Time of application code

BMS ID	6529			
Definition	The time when the product should be applied.			
Code value	Code value is specified according to codelist T4346, see www.gs1.se/en-codelist-T4346			
Level	Component	Base	Case	Pallet
M = mandatory C = conditional - = not used	-	C	C	-

T4347 Skin product function or treatment code

BMS ID	6552			
Definition	The function of a skin care product.			
Example	Anti-aging, Moisturising, Sun protection			
Code value	Code value is specified according to codelist T4347, see www.gs1.se/en-codelist-T4347			
Level	Compenent	Base	Case	Pallet
M = mandatory C = conditional - = not used	-	C	C	-

T4348 Target skin type code

BMS ID	6552			
Definition	The type of skin the product is intended for.			
Example	Dry, Normal, Oily			
Code value	Code value is specified according to codelist T4348, see www.gs1.se/en-codelist-T4348			
Level	Compenent	Base	Case	Pallet
M = mandatory C = conditional - = not used	-	C	C	-

T4349 Hair product function or treatment code

BMS ID	6548			
Definition	The function of a hair care product.			
Example	Anti-frizz, Anti-dandruff			
Code value	Code value is specified according to codelist T4349, see www.gs1.se/en-codelist-T4349			
Level	Compenent	Base	Case	Pallet
M = mandatory C = conditional - = not used	-	C	C	-

T4350 Target hair type code

BMS ID	6549			
Definition	The type of hair the product is intended for.			
Example	Curly, Dry, Relaxed			
Code value	Code value is specified according to codelist T4350, see www.gs1.se/en-codelist-T4350			
Level	Compenent	Base	Case	Pallet
M = mandatory C = conditional - = not used	-	C	C	-

T4351 Natural hair colour code

BMS ID	6550			
Definition	The natural colour of the hair for which the product is intended.			
Example	Blonde, Grey, Brown			
Code value	Code value is specified according to codelist T4351, see www.gs1.se/en-codelist-T4351			
Level	Component	Base	Case	Pallet
M = mandatory C = conditional - = not used	-	C	C	-

Battery type information

This group of attributes refers to battery information for a trade item.

Level	Component	Base	Case	Pallet
M = mandatory C = conditional - = not used	-	C	-	-

T3800 Are batteries included

BMS ID	600			
Definition	Indicates if batteries are either included or not included with the trade item.			
Level	Component	Base	Case	Pallet
M = mandatory C = conditional - = not used	-	C	-	-

T3801 Are batteries required

BMS ID	601			
Definition	Indicates if batteries are required to operate the trade item.			
Level	Component	Base	Case	Pallet
M = mandatory C = conditional - = not used	-	C	-	-

T3802 Are batteries built in

BMS ID	612			
Definition	This code is defined as an indicator whether or not any batteries included with the trade item are built into the trade item during manufacturing and cannot be changed or removed.			
Level	Component	Base	Case	Pallet

M = mandatory C = conditional - = not used	-	C	-	-
--	---	---	---	---

T4750 Quantity of batteries built in

BMS ID	617			
Definition	The quantity of batteries built into the trade item during manufacturing. This includes batteries that can or cannot be changed or removed.			
Level	Component	Base	Case	Pallet
M = mandatory C = conditional - = not used	-	C	-	-

T3803 Battery technology type code

BMS ID	613			
Definition	The type of battery family of batteries used by the product.			
Description	Repeatable per battery technology type contained in the trade item			
Example	Lithium, NiMH			
Code Value	Code value is specified according to code list T3803, see www.gs1.se/en-codelist-T3803 .			
Level	Component	Base	Case	Pallet
M = mandatory C = conditional - = not used	-	C	-	-

T3804 Battery type code

BMS ID	614			
Definition	Type of battery required to operate the game.			
Description	If "T3801 Are Batteries Required" or if "T3805 Quantity of Batteries" is populated or if "T3800 Are Batteries Included" = "Yes" this attribute is required.			
Code Value	Code value is specified according to code list T3804, see www.gs1.se/en-codelist-T3804 .			
Level	Component	Base	Case	Pallet
M = mandatory C = conditional - = not used	-	C	-	-

T3805 Quantity of batteries required

BMS ID	618			
Definition	The number of batteries required to operate the trade item.			









Level	Component	Base	Case	Pallet
M = mandatory C = conditional - = not used	-	C	-	-

GHS details

This group of attributes is related to the Globally Harmonized System of Classification and Labelling of Chemicals.

Level	Component	Base	Case	Pallet
M = mandatory C = conditional - = not used	-	C	C	C

T3745 GHS Symbol description code

BMS ID	3238		
Definition	Code indicating the symbol that depicts health, physical and environmental hazard information according to GHS.		
Code value	Code value is specified according to code list T3745, see www.gs1.se/en-codelist-T3745 .		
Pictograms	Corrosion		
	Environment		
	Exclamation mark		
	Exploding bomb		
	Flame		
	Flame over circle		
	Gas cylinder		
Health hazard			

	Skull and crossbones			
	No pictogram	-		
Level	Component	Base	Case	Pallet
M = mandatory C = conditional - = not used	-	C	C	C

T5044 GHS signal words code

BMS ID	3237			
Definition	Code indicating the signal word according to GHS (The Globally Harmonized System of Classification and Labelling of Chemicals) for the item.			
Description	Words such as "Danger" or "Warning" used to emphasize hazards and indicate the relative level of severity of the hazard. Read more about how the attribute is used in chapter Trade Item Information to comply with CLP regulation .			
Code value	Code value is specified according to code list T5044, see www.gs1.se/en-codelist-T5044 .			
Level	Component	Base	Case	Pallet
M = mandatory C = conditional - = not used	-	C	C	C

Hazard statement

Standard phrases describing the nature of a hazard per GHS. If the trade item has several hazard statements the whole group is repeated for every hazard statements.

Level	Component	Base	Case	Pallet
M = mandatory C = conditional - = not used	-	C	C	C

T5047 Hazard statements code

BMS ID	3240			
Definition	Standard phrases assigned to a hazard class and category that describe the nature of the hazard.			
Description	Read more about how the attribute is used in chapter Trade Item Information to comply with CLP regulation .			
Code value	Code value is specified according to the CLP regulation found on the Swedish Chemicals Agency, see www.kemi.se/en .			
Level	Component	Base	Case	Pallet
M = mandatory C = conditional - = not used	-	C	C	C

T5048 Hazard statements description

BMS ID	3241			
Definition	A description in free text of standard phrases assigned to a hazard class and category describing the nature of the hazard.			
Description	<p>Always specify the information in Swedish. The text must be exactly as on the packaging.</p> <p>Read more about how the attribute is used in chapter Trade Item Information to comply with CLP regulation.</p>			
Note	Allows for the representation of the same value in different languages, but not for multiple values.			
Level	Component	Base	Case	Pallet
M = mandatory C = conditional - = not used	-	C	C	C

Precautionary statement

Measures listed on a hazardous label to minimize or prevent adverse effects as per GHS. If the trade item has several precautionary statements the whole group is repeated for every precautionary statement.

Level	Component	Base	Case	Pallet
M = mandatory C = conditional - = not used	-	C	C	C

T5049 Precautionary statements code

BMS ID	3244			
Definition	Measures listed on a hazardous label to minimize or prevent adverse effects.			
Description	Read more about how the attribute is used in chapter Trade Item Information to comply with CLP regulation .			
Code value	Code value is specified according to the CLP regulation found on the Swedish Chemicals Agency, see www.kemi.se/en .			
Level	Component	Base	Case	Pallet
M = mandatory C = conditional - = not used	-	C	C	C

T5050 Precautionary statements description

BMS ID	3245			
Definition	A description in free text of the measures listed on a hazardous label to minimize or prevent adverse effects.			

Description	<p>The Precautionary statements description should be followed by the compound the precautionary statement refers to. The package should be marked with the compound adjacent to the precautionary statement package mark.</p> <p>Always specify the information in Swedish. The text must be exactly as on the packaging.</p> <p>Read more about how the attribute is used in chapter Trade Item Information to comply with CLP regulation.</p>			
Note	Allows for the representation of the same value in different languages, but not for multiple values.			
Level	Component	Base	Case	Pallet
M = mandatory C = conditional - = not used	-	C	C	C

Material

Details on the composition of any materials used to make a trade item.

Level	Component	Base	Case	Pallet
M = mandatory C = conditional - = not used	-	C	C	-

T4363 Trade item material designation description

BMS ID	3443			
Definition	The description of the element of place on the trade item, that the material information is being described. For example: filling, outer, eyes, trim.			
Level	Component	Base	Case	Pallet
M = mandatory C = conditional - = not used	-	C	C	-

T4364 Material statement

BMS ID	6280			
Definition	Used to indicate the materials that are used in durable products. Material Statement is written as it is on the product or its label.			
Level	Component	Base	Case	Pallet
M = mandatory C = conditional - = not used	-	C	C	-

T4365 Material code

BMS ID	3454			
Definition	This element indicates the product material code that gives the composition of the trade item's first main material up to six material short codes that can be given in descending order of their respective percentages.			
Description	The attribute is mandatory if "T4367 Material percentage" is used. The attribute can be repeated if the trade item consists of several different materials.			
Code value	Code value is specified according to code list T4365 Material code .			
Level	Component	Base	Case	Pallet
M = mandatory C = conditional - = not used	-	C	C	-

T4366 Material content

BMS ID	3455			
Definition	This element is used to indicate the material composition.			
Level	Component	Base	Case	Pallet
M = mandatory C = conditional - = not used	-	C	C	-

T4367 Material percentage

BMS ID	3457			
Definition	Net weight percentage of a product material of the first main material. The percentages must add up to 100.			
Description	The attribute is mandatory if "T4365 Material code" is used. The attribute can be repeated if the trade item consists of several different materials.			
Level	Component	Base	Case	Pallet
M = mandatory C = conditional - = not used	-	C	C	-

T4368 Material thread count

BMS ID	3458			
Definition	This element is used to specify the quality of material (fabric) of a trade item.			
Level	Component	Base	Case	Pallet
M = mandatory C = conditional - = not used	-	C	C	-

T4369 Material weight

BMS ID	3460			
---------------	------	--	--	--

Definition	The measured weight of the material expressed in ounces per square yard or grams per square meter.			
Level	Component	Base	Case	Pallet
M = mandatory C = conditional - = not used	-	C	C	-

T4370 Thread denier

BMS ID	6565			
Definition	Denier is a measurement for fabric and threads. It is the mass in grams per 9,000 meters (9 kilometres) of the fibre/thread. The denier is based on a natural reference: a single strand of silk is approximately one denier; a 9000-meter strand of silk weighs about one gram (1 denier = 1 g / 9000 m).			
Level	Component	Base	Case	Pallet
M = mandatory C = conditional - = not used	-	C	C	-

T4402 Material density

BMS ID	8641			
Definition	The density of the material expressed as its mass per unit volume, e.g., kilograms per cubic metre or pounds per cubic foot.			
Code value	Code value for measurement unit is specified according to code list T3780 Measurement unit code .			
Note	The attribute refers to the density of the trade item's material. The density of the packaging material is specified in "T4404 Packaging material density".			
Level	Component	Base	Case	Pallet
M = mandatory C = conditional - = not used	-	C	C	-

Package

This group is used to specify the type of packaging used, for example a bottle or box, whether the package is returnable, and deposit information for the package, if any.

Level	Component	Base	Case	Pallet
M = mandatory C = conditional - = not used	-	M	M	M

T0189 Packaging terms and conditions code

BMS ID	2177
---------------	------

Definition	Code indicating whether the supplier has paid the appropriate fee for recycling of the packaging material.			
Description	<p>The attribute is only used if the fee for packaging material is paid.</p> <p>Read more about how the attribute is used in the separate Guideline for Packaging Material.</p> <p>The trade items in a hierarchy have normally the same status, i.e. the fee is paid or not paid for every item in the hierarchy. An exception is item trade item hierarchies with returnable packages or unpacked trade items.</p>			
Code value	Code value is specified according to code list T0189, see www.gs1.se/en-codelist-T0189 .			
Level	Component	Base	Case	Pallet
M = mandatory C = conditional - = not used	-	C	C	C

T0137 Packaging type code

BMS ID	2186			
Definition	Code indicating the type of package or container in which the goods are packed.			
Description	<p>Package type is important information for logistics. Many buyers use robots for automatic picking of goods. If an item cannot be picked automatically due to package type, the buyer must be informed about this in advance.</p> <p>Package type is also used for shelf planning. Certain package types, for example gable tops, are not possible to stack. Other package types, for example roll packs, need an edge to not roll off the shelf.</p> <p>Primarily, the attribute is used to enter the main packaging type. To specify the different packaging parts of the trade item, "T4354 Packaging material element code" is recommended.</p> <p>Read more about how the attribute is used in the separate Guideline for Packaging Material.</p>			
Code value	Code value is specified according to code list T0137, see www.gs1.se/en-codelist-T0137			
Level	Component	Base	Case	Pallet
M = mandatory C = conditional - = not used	-	M	M	M

T2207 Is trade item a display unit

BMS ID	151			
Definition	Code indicating whether the item is a display unit.			
Description	The attribute is only used if this trade item is a display unit. If the attribute is not used, then it means that the item is not a display unit.			
Code value	true - display unit false - not a display unit			
Level	Component	Base	Case	Pallet
M = mandatory C = conditional - = not used	-	-	C	C

T4372 Packaging sustainability feature code

BMS ID	2176
Definition	A feature of the packaging that contributes to sustainability initiatives for example that it is made from renewable materials.
Example	If the packaging is made from recycled material, the code MADE_FROM_RECYCLED_MATERIAL should be entered.
Note	The attribute refers to the packaging characteristics specified in "T0137 Packaging type code". i.e the entire packaging and not the various constituent materials.

Code value	Code value is specified according to code list T4372 Packaging sustainability feature code .			
Level	Component	Base	Case	Pallet
M = mandatory C = conditional - = not used	-	C	C	C

T0277 Is packaging marked returnable

BMS ID	2308			
Definition	Code indicating whether the packaging is returnable, that is, whether or not the package may be returned to be refilled.			
Description	Some returnable packages have a deposit. Some examples are returnable bottles, bread crates, roll cage for dairy products and euro pallet. Read more about how the attribute is used in the separate Guideline for Packaging Material .			
Code value	true - returnable packing false - not returnable packing			
Level	Component	Base	Case	Pallet
M = mandatory C = conditional - = not used	-	C	C	C

Deposit and returnable assets

This group is only used if a deposit is charged for the trade item and if the code value for "T0277 Is packaging marked returnable" is "true" and the packaging can be returned for reuse or recycling.

Level	Component	Base	Case	Pallet
M = mandatory C = conditional - = not used	-	C	C	C

T4149 Returnable package deposit region

BMS ID	2300			
Definition	Code indicating the geographic region associated with the returnable package deposit amount.			

Code value	Code value is specified according to code list T3783, see www.gs1.se/en-codelist-T3783 . Code is specified according to ISO 3166-1 (three-digit numeric).			
Level	Component	Base	Case	Pallet
M = mandatory C = conditional - = not used	-	C	C	C

Packaging material

This group is used to provide information about packaging material. Producers are responsible for ensuring that packaging gets recycled and that associated fees are paid. Since fees vary based on packaging properties, it may be necessary to specify these.

If several materials are used, the type and weight are given for each.

Read more about how the attributes in this group are used in the separate [Guideline for Packaging Material](#).

Level	Component	Base	Case	Pallet
M = mandatory C = conditional - = not used	-	C	C	C

T1188 Packaging material type code

BMS ID	2206			
Definition	Code indicating what the packaging material the package consists of.			
Description	<p>Buyers may need to know packaging material type. Check with your buyer to determine what their requirements are.</p> <p>The attribute is mandatory if "T1189 Packaging material composition quantity" is used.</p> <p>If a trade item has several types of packaging material, packaging material can be supplied several times using this attribute.</p> <p>Please note that packaging materials do not need to be filled in when:</p> <ul style="list-style-type: none"> ■ The trade item does not have any packaging material, such as a baked potato ■ The trade item has returnable packaging which should therefore not be recycled <p>Read more about how the attribute is used in the separate Guideline for Packaging Material.</p>			
Code value	Code value is specified according to code list T1188, see www.gs1.se/en-codelist-T1188 .			
Level	Component	Base	Case	Pallet
M = mandatory C = conditional - = not used	-	C	C	C

T1189 Packaging material composition quantity

BMS ID	2214
Definition	Weight of the specified packaging material per package and packaging material.
Description	<p>The attribute is mandatory if "T1188 Packaging material type code" is used.</p> <p>Read more about how the attribute is used in the separate Guideline for Packaging Material.</p>
Example	870

Code Value	Code value for measurement unit is specified according to code list "T3780 Measurement unit code". See www.gs1.se/en-codelist-T3780 . For "T1189 Packaging material composition quantity" choose code value: GRM - gram			
Level	Component	Base	Case	Pallet
M = mandatory C = conditional - = not used	-	C	C	C

T4371 Is packaging material recoverable

BMS ID	2207			
Definition	Determines whether packaging material is recoverable. Recoverable materials are those which are capable of being reused or returned to use in the form of raw materials.			
Level	Component	Base	Case	Pallet
M = mandatory C = conditional - = not used	-	C	C	C

Dimensions

This group is used to specify various physical dimensions and weights of the trade item and declare price comparison measurement value for the trade item.

Level	Component	Base	Case	Pallet
M = mandatory C = conditional - = not used	-	M	M	M

T4017 Trade item measurements, width

BMS ID	3739			
Definition	The width of the trade item, as measured according to the GS1 Package and Product Measurement Standard. If the trade item is a unit load, include the shipping platform unless it is excluded according to the platformTypeCode chosen.			
Description	<p>Measurement value is specified in millimeter (mm). The information is used to calculate e.g. how a trade item can be shipped, packaged, handled in stock and on the store shelf.</p> <p>Trade item width is not permitted to be changed with more than 20% without assigning the trade item a new GTIN (Global Trade Item Number). Read more about GS1's GTIN rules at www.gs1.org/gtinrules.</p> <p>The width of the trade item should be changed if it is less than 20% from the original value. Even a small adjustment can affect the entire logistics flow, including e-commerce and planograms.</p>			
Example	225			
Code Value	Code value for measurement unit is specified according to code list "T3780 Measurement unit code", see www.gs1.se/en-codelist-T3780 . For "T4017 Trade item measurements, width" choose code value: MMT – millimeter			

Read more	See GS1 Package and Product Measurement Standard for the full set of rules regarding determination of trade item measurements.			
Level	Component	Base	Case	Pallet
M = mandatory C = conditional - = not used	-	M	M	M

T4019 Trade item measurements, height

BMS ID	3725			
Definition	The height of the trade item, as measured according to the GS1 Package and Product Measurement Standard. If the trade item is a unit load, include the shipping platform unless it is excluded according to the platformTypeCode chosen.			
Description	<p>Measurement value is specified in millimeter (mm).</p> <p>The information is used to calculate e.g. how a trade item can be shipped, packaged, handled in stock and on the store shelf.</p> <p>At a pallet level the Trade item height will include the height of the pallet itself.</p> <p>Trade item height is not permitted to be changed with more than 20 % without assigning the trade item a new GTIN (Global Trade Item Number). Read more about GS1's GTIN rules at www.gs1.org/gtinrules.</p> <p>The height of the trade item should be changed if it is less than 20% from the original value. Even a small adjustment can affect the entire logistics flow, including e-commerce and planograms.</p>			
Example	150			
Code Value	<p>Code value for measurement unit is specified according to code list "T3780 Measurement unit code" see www.gs1.se/en-codelist-T3780.</p> <p>For "T4019 Trade item measurements, height" choose code value: MMT – millimeter</p>			
Read more	See GS1 Package and Product Measurement Standard for the full set of rules regarding determination of trade item measurements.			
Level	Component	Base	Case	Pallet
M = mandatory C = conditional - = not used	-	M	M	M

T4018 Trade item measurements, depth

BMS ID	3721			
Definition	The depth of the trade item, as measured according to the GS1 Package and Product Measurement Standard. If the trade item is a unit load, include the shipping platform unless it is excluded according to the platformTypeCode chosen.			
Description	<p>The measurement value is specified in millimeter (mm).</p> <p>The information is used to calculate e.g. how a trade item can be shipped, packaged, handled in stock and on the store shelf.</p> <p>Trade item depth is not permitted to be changed with more than 20 % without assigning the trade item a new GTIN (Global Trade Item Number). Read more about GS1's GTIN rules at www.gs1.org/gtinrules.</p> <p>The depth of the trade item should be changed if it is less than 20% from the original value. Even a small adjustment can affect the entire logistics flow, including e-commerce and planograms.</p>			
Example	330			

Code Value	Code value for measurement unit is specified according to code list "T3780 Measurement unit code" see www.gs1.se/en-codelist-T3780 . For "T4018 Trade item measurements, depth" choose code value: MMT – millimeter
-------------------	--

Read more	See GS1 Package and Product Measurement Standard for the full set of rules regarding determination of trade item measurements.			
Level	Component	Base	Case	Pallet
M = mandatory C = conditional - = not used	-	M	M	M

T4362 Size type code

BMS ID	7230			
Definition	The type of size dimension for the size measurement or size description.			
Description	Used together with "T4361 Size dimension" to specify the dimensions of a specific part of a trade item. It can be the capacity of a wine glass or the size of the cooking surface. The attribute is mandatory if "T4361 Size dimension" is used.			
Code value	Code value is specified according to code list T4362 Size type code .			
Level	Component	Base	Case	Pallet
M = mandatory C = conditional - = not used	-	C	C	-

T4361 Size dimension

BMS ID	7222			
Definition	The numerical size measurement of the size dimension specified by the size type.			
Description	Used together with "T4362 Size type code" to specify the dimensions of a specific part of a trade item. It can be the capacity of a wine glass or the size of the cooking surface. The attribute is mandatory if "T4362 Size type code" is used.			
Example	200 mm, 20 cl			
Code value	Code value for measurement unit is specified according to code list "T3780 Measurement unit code", see http://www.gs1.se/en-codelist-T3780 . Choose a valid unit of measure based on the specified size type.			
Level	Component	Base	Case	Pallet
M = mandatory C = conditional - = not used	-	C	C	-

T4020 Trade item gross weight

BMS ID	3777			
Definition	The gross weight of the item including all content and packaging material.			

Description	<p>In order to be able to plan transports, it is very important to know how much the trade items weigh because trucks have an upper limit for how heavy goods they can carry. The gross weight of the trade item includes all packaging material for the trade item. At the pallet level, the weight of the load carrier, usually the pallet, is also included in the gross weight.</p> <p>At pallet level the trade item gross weight includes the weight of the pallet itself.</p> <p>The gross weight is stated in grams.</p> <p>Trade item gross weight is not permitted to be changed with more than 20 % without assigning the trade item a new GTIN (Global Trade Item Number). Read more about GS1's GTIN rules at www.gs1.org/gtinrules</p>			
Example	265000			
Code Value	<p>Code value for measurement unit is specified according to code list "T3780 Measurement unit code" see www.gs1.se/en-codelist-T3780.</p> <p>For T4020 Trade item gross weight choose code value: GRM – gram</p>			
Level	Component	Base	Case	Pallet
M = mandatory C = conditional - = not used	-	C	C	C

T0147 Price comparison measurement

BMS ID	3330
Definition	The contents of the package when used or, where appropriate, after preparation.
Description	<p>The attribute is used for calculating comparison contents or price. What type of price comparison that can be calculated is specified in "T0145 Price comparison measurement code"</p> <p>This attribute is mandatory if the trade item is a consumer unit, to avoid misunderstanding, even if it is the same as "T0082 Net content".</p>
	<p>Read more about how the attribute is used in chapter Comparative price.</p> <p>Comparative equivalent content is not permitted to be changed without assigning the trade item a new GTIN (Global Trade Item Number). Read more about GS1's GTIN rules at www.gs1.org/gtinrules.</p>
Example	215.3
Code Value	<p>Code value for comparison measurement unit is specified according to code list "T3780 Measurement unit code", see www.gs1.se/en-codelist-T3780.</p> <p>For "T0147 Price comparison measurement unit" choose one of the code values:</p> <p>GRM – gram</p> <p>MLT – milliliter</p> <p>MMT – millimeter</p> <p>MTK – square meter</p> <p>MTQ – cubic meter</p> <p>H87 - piece</p>

Level	Component	Base	Case	Pallet
M = mandatory C = conditional - = not used	-	C	C	-

T0145 Price comparison content type code

BMS ID	3329			
Definition	Code indicating how price comparison measurement can be calculated, or what kind of comparison of amount that can be made, based on the comparison measurement value.			
Description	<p>This attribute is mandatory if the trade item is a consumer unit.</p> <p>The three attributes "T0147 Price comparison measurement", "T3780 Unit of measure for comparison measurement combined with T0147" and "T0145 Price comparison measurement code" are used as a basis for calculating the price comparison shown to the consumer. Read more about how these attributes are used in chapter Comparative price.</p> <p>Provide herring weight using code value "By drained weight." Read more in Fiskbranschens Riksförbunds "Branschriktlinjer för viktangivelse och mätning av sillvikt i inläggningar" at www.slv.se or www.fiskbranschen.com.</p>			
Example	<p>A package of washing powder contains 800 gram. The price comparison is based on the contents expressed as a number of washes (21) allowing this to be presented to the consumer as price per wash:</p> <ul style="list-style-type: none"> ■ "T0082 Net content": 800 ■ "T3780 Unit of measure for net contents": GRM ■ "T0147 Price comparison measurement": 21 ■ "T3780 Unit of measure for comparison measurement": H87 (piece) ■ "T0145 Price comparison measurement code": PER_WASH <p>A multipack contains 10 ice creams (50g/piece). The price comparison is based on the content expressed as number of pieces (10) allowing this to be presented to the consumer as price per piece:</p> <ul style="list-style-type: none"> ■ "T0082 Net content": 500 ■ "T3780 Unit of measure for net contents": GRM ■ "T0147 Price comparison measurement": 10 ■ "T3780 Unit of measure for comparison measurement": H87 (piece) ■ "T0145 Price comparison measurement code": PER_PIECE 			
Code value	<p>The code value is based on the information in "T0147 Price comparison measurement".</p> <p>Code value is specified according to code list T0145, see www.gs1.se/en-codelist-T0145.</p>			
Note	More information and examples can be found at www.konsumentverket.se .			
Level	Component	Base	Case	Pallet
M = mandatory C = conditional - = not used	-	C	C	-

Net content

The net content can be repeated for an item if the supplier wants to specify the contents in several ways, for example both 800 grams and 75 pieces for a package of meatballs.

Level	Component	Base	Case	Pallet
M = mandatory C = conditional - = not used	-	C	C	-

T0082 Net content

BMS ID	3733			
Definition	The amount of the trade item contained in the package.			
Description	<p>The attribute is used for specifying the net content in the package.</p> <p>The attribute is mandatory if the trade item is a consumer unit.</p> <p>Package contents is not permitted to be changed without assigning the trade item a new GTIN (Global Trade Item Number). Read more about GS1's GTIN rules at www.gs1.org/gtinrules.</p>			
Example	10.5			
Code Value	<p>Code value for measurement unit in which the net contents value is expressed is specified according to code list "T3780 Measurement unit code" see www.gs1.se/en-codelist-T3780.</p> <p>For "T0082 Net content" measurement unit choose one of the code values:</p> <p>GRM – gram</p> <p>MLT – milliliter (use for alcohol products)</p> <p>MMT – millimeter</p> <p>MTK – square meter</p> <p>MTQ – cubic meter</p> <p>H87 - piece</p>			
Note	<p>For food preserved in liquid, both total weight and drained weight must be entered.</p> <p>Specify the net weight including liquid in the following attribute: "T0082 Net content, value"</p> <p>To specify weight excluding liquid, so-called drained weight, use the following attributes together: "T0145 Price comparison content type code": DRAINED_WEIGHT – By drained weight "T0147 Price comparison measurement"</p>			
Level	Component	Base	Case	Pallet
M = mandatory C = conditional - = not used	C	C	C	-

Storage and handling

This group of attributes can be used to specify how the item should be stored and handled.

Level	Component	Base	Case	Pallet
M = mandatory C = conditional - = not used	-	C	C	C

T0167 Minimum trade item lifespan from time of production

BMS ID	3704			
Definition	Time this trade item can be stored in the specified environment, i.e. the period from manufacture or packing to best-before date.			
Description	<p>The shelf life is stated in days and according to local rules and regulations.</p> <p>The attribute is mandatory for food and pharmaceutical consumer units, with some exceptions.</p> <p>For exceptions, for example bakery trade items with a 24h shelf life and no date on the packaging, this attribute should not be used. Instead, enter NO_DATE_MARKED in "T4032 Trade item date on packaging format type code".</p>			
Example	14			
Level	Component	Base	Case	Pallet
M = mandatory C = conditional - = not used	-	C	C	-

T2521 Opened trade item lifespan

BMS ID	3705			
Definition	The number of days the trade item that had been opened can remain on the shelf and must then be removed.			
Description	<p>The attribute is used for trade items being divided and packaged. The information can amongst others be used to mark trade items, being divided and packaged in store, with expiry date.</p> <p>The lifespan is stated in number of days.</p> <p>Note that information intended for the consumer is not specified here but in "T3776 Consumer usage instructions".</p> <p>If the product carries an Open Jar symbol, use the term T4269 Item period safe to use after opening to enter the information.</p>			
Example	15			
Level	Component	Base	Case	Pallet
M = mandatory C = conditional - = not used	-	C	C	C

T4269 Item period safe to use after opening

BMS ID	3709			
Definition	The period after opening the product during which it is still safe to be used.			
Description	The term shall only be used when the product carries an Open Jar symbol. This may appear for example on soap, shampoo, cosmetics, etc.			
Example	6			

Code Value	<p>Code value for measurement unit is specified according to code list "T4270 Time measurement unit code", see https://www.gs1.se/en-codelist-t4270.</p> <p>For "T4269 Item period safe to use after opening" choose one of these code values:</p> <p>MON – month</p> <p>ANN – year</p>			
Level	Component	Base	Case	Pallet
M = mandatory C = conditional - = not used	<p>-</p>	<p>C</p>	<p>C</p>	<p>C</p>

T3822 Temperature qualifier code

BMS ID	3830			
Definition	Code qualifying the type of a temperature requirement for example Storage and handling.			
Description	This attribute can be used together with "T3796 Maximum temperature" and "T3797 Minimum temperature". These attribute together can be repeated depending on how many types of temperatures that are in demand.			
Code Value	Code value for is specified according to code list "T3846 Temperature qualifier code", see www.gs1.se/en-codelist-T3846 .			
Level	Component	Base	Case	Pallet
M = mandatory C = conditional - = not used	-	M	M	M

T3796 Maximum temperature

BMS ID	3820			
Definition	The maximum temperature that a trade item can be held below defined by the manufacturer without affecting product safety or quality.			
Description	<p>This attribute can be used together with "T3822 Temperature qualifier code" and "T3797 Minimum temperature". These attributes can be repeated depending on how many types of temperatures that are in demand.</p> <p>The attribute is used for temperature sensitive products. The temperature must be specified in degrees Celsius. It is recommended that the temperature is not specified with a greater accuracy than whole degrees.</p>			
Example	25			
Code Value	<p>Code value for T3796 and temperature measurement unit is specified according to code list "T3781 Temperature measurement unit code", see www.gs1.se/en-codelist-T3781.</p> <p>For "T3796 Maximum temperature" unit choose code value: CEL — Celsius</p>			
Level	Component	Base	Case	Pallet
M = mandatory C = conditional - = not used	-	C	C	C

T3797 Minimum temperature

BMS ID	3826			
Definition	The minimum temperature that a trade item can be held below defined by the manufacturer without affecting product safety or quality.			
Description	<p>This attribute can be used together with "T3822 Temperature qualifier code" and "T3796 Maximum temperature". These attributes together can be repeated depending on how many types of temperatures that are in demand.</p> <p>The attribute is used for temperature sensitive products. The temperature must be specified in degrees Celsius. It is recommended that the temperature is not specified with a greater accuracy than whole degrees.</p>			

Example	12			
Code Value	<p>The code value for T3797 and temperature measurement unit is specified according to code list "T3781 Temperature measurement unit code", see www.gs1.se/en-codelist-T3781.</p> <p>For "T3797 Minimum temperature" unit choose code value: CEL — Celsius.</p>			
Level	Component	Base	Case	Pallet
M = mandatory C = conditional - = not used	-	C	C	C

T0157 Stacking factor

BMS ID	3604			
Definition	Maximum number of items that can be stacked without damaging the goods.			
Description	<p>Some items can be damaged if they are stacked with heavy items on top of them. It is therefore essential to know how sensitive an item is to be crushed in order to plan how the packages should be transported or placed on the store shelf.</p> <p>The attribute is used for specifying the maximum number of trade item packages that can be stacked without damaging the goods.</p> <p>The stacking factor should be specified for the current trade item level.</p>			
Example	<p>If a maximum of 3 items can be stacked on one another, the stacking factor is 3.</p> <p>If no further pallets may be stacked on a pallet, the stacking factor is 1.</p>			
Level	Component	Base	Case	Pallet
M = mandatory C = conditional - = not used	-	C	C	M

T3848 Stacking factor type code

BMS ID	3607			
Definition	Indicates the supply chain process that the particular product may be stacked in.			
Description	<p>From a supply chain perspective, these values can differ from a storage perspective, truck transport, rail, etc.</p> <p>For example, a transportation by road can only be stack 2 pallets high, but in a warehouse that can be 3 pallets.</p> <p>Use this attribute in combination with "T0157 Stacking factor". This combination is repeatable depending where in the supply chain the trade item should be handled.</p>			
Code Value	Code value for is specified according to code list "T3848 Stacking factor type code" see www.gs1.se/en-codelist-T3848 .			
Level	Component	Base	Case	Pallet

M = mandatory C = conditional - = not used	-	C	C	M
---	---	---	---	---

Dangerous goods

This group of attributes is used to specify characteristics for item classed as dangerous goods. More information concerning dangerous goods can be found on the Swedish Civil Contingencies Agency website, www.msb.se.

Level	Component	Base	Case	Pallet
M = mandatory C = conditional - = not used	-	C	C	C

T0263 Class of dangerous goods code

BMS ID	3879			
Definition	The dangerous goods classification of the trade item.			
Description	Dangerous classes explain in general terms the hazardous nature and properties of the goods and serve to classify them together in terms of their most significant risk. There are nine classes, some with sub-classes. The code indicates the type of risk for the product. The most significant risk should be indicated.			
Code value	Code value is specified according to code list T0263, see www.gs1.se/en-codelist-T0263 . Code list T0263 is a restricted code list managed by GS1 Sweden. For a full code list see external code list at www.msb.se .			
Level	Component	Base	Case	Pallet
M = mandatory C = conditional - = not used	-	C	C	C

T3743 Dangerous goods classification code

BMS ID	3880			
Definition	Code indicating the classification of the dangerous goods for transport by road and rail according to for example ADR/RID.			
Code value	T3743 refers to an external code list, see www.msb.se .			
Level	Component	Base	Case	Pallet
M = mandatory C = conditional - = not used	-	C	C	C

T0264 Dangerous goods packing group

BMS ID	3882			
Definition	Code indicating level of danger, that is, how dangerous a substance or an object is considered to be.			
Description	I – Very dangerous substances – group I II – Dangerous substances – group II III – Substances with a low level of danger – group III			
Code Value	T0264 refers to an external code list, see www.msb.se .			
Level	Component	Base	Case	Pallet
M = mandatory C = conditional - = not used	-	C	C	C

T4023 Flash point temperature

BMS ID	3866			
Definition	The lowest temperature at which a substance gives off a sufficient vapor to support combustion.			
Example	12			
Code Value	Code value for measurement unit is specified according to code list "T3781 Temperature measurement unit code", see www.gs1.se/en-codelist-T3781 . For "T4023 Flash point temperature" choose code value: CEL – Celsius			
Level	Component	Base	Case	Pallet
M = mandatory C = conditional - = not used	-	C	C	C

T4303 Net mass of explosives

BMS ID	3892			
Definition	The measurement of the net explosive mass of the trade item (dangerous goods) for transport by road and rail according to a dangerous goods classification regulation.			
Description	The attribute is used to state the weight of a dangerous good in grams or milliliters when net content for the dangerous good has been stated in "pieces" in T0082 Net content.			
Code Value	Code value for measurement unit is specified according to code list "T3780 Measurement unit code", see www.gs1.se/en-codelist-T3780 . For "T4303 Net mass of explosives" choose code value: GRM – gram MLT– milliliter			
Level	Component	Base	Case	Pallet

M = mandatory C = conditional - = not used	-	C	C	C
--	---	---	---	---

T0169 United Nations dangerous goods number

BMS ID	3894			
Definition	UN code for this product from the ADR code list (Accord Europeen relative au transport international des marchandises).			
Description	The attribute is used when the product is classified as dangerous.			
Code value	T0169 refers to an external code list, see www.msb.se .			
Level	Component	Base	Case	Pallet
M = mandatory C = conditional - = not used	-	C	C	C

T4026 Dangerous goods shipping name

BMS ID	3883			
Definition	Shipping name of the trade item (dangerous goods).			
Description	The attribute is used for describing the recognized agencies (see dangerousGoodsRegulationsCodes), in their regulations, provide a list of all acceptable proper shipping names.			
Level	Component	Base	Case	Pallet
M = mandatory C = conditional - = not used	-	C	C	C

T4027 Dangerous goods technical name

BMS ID	3885			
Definition	Provides the dangerous goods technical information.			
Note	Allows for the representation of the same value in different languages, but not for multiple values. Always specify the information in Swedish.			
Level	Component	Base	Case	Pallet
M = mandatory C = conditional - = not used	-	C	C	C

T4247 Dangerous goods limited quantities code

BMS ID	6061			
Definition	A code defined by an agency specifying whether a dangerous good can be packaged in small quantities providing they are packaged and labelled in accordance with certain requirements.			
Code Value	Code value for is specified according to code list "T4247 Dangerous goods limited quantities code" see www.gs1.se/en-codelist-T4247 .			
Level	Component	Base	Case	Pallet
M = mandatory C = conditional - = not used	-	C	C	C

T4141 Hazardous material additional information

BMS ID	3868			
Definition	Any regulatory information required that is not specifically identified by another field.			
Note	Allows for the representation of the same value in different languages, but not for multiple values. Always specify the information in Swedish.			
Level	Component	Base	Case	Pallet
M = mandatory C = conditional - = not used	-	C	C	C

T4142 Dangerous goods special provisions

BMS ID	3884			
Definition	Code indicating the special regulations to be met regarding a Dangerous Goods Classification Regulation.			
Code Value	T4142 refers to an external code list, see www.msb.se .			
Level	Component	Base	Case	Pallet
M = mandatory C = conditional - = not used	-	C	C	C

T3741 ADR tunnel restriction code

BMS ID	3863			
Definition	Code indicating the road tunnel restriction for the trade item according to ADR.			
Code value	T3741 refers to an external code list, see www.msb.se .			
Level	Component	Base	Case	Pallet

M = mandatory C = conditional - = not used	-	C	C	C
--	---	---	---	---

T3744 Transport category code

BMS ID	3887			
Definition	Code indicating the transport category of the trade item according to ADR.			
Description	Transport categories are used to calculate the quantity of dangerous goods allowed to be transported on the same transport unit under specific exemption rules.			
Code Value	Code value is specified according to code list T3744 Transport category code .			
Level	Component	Base	Case	Pallet
M = mandatory C = conditional - = not used	-	C	C	C

Dangerous goods hazard label

This group of attributes is used to specify information about dangerous goods hazard labels, if any. A Dangerous goods hazard label is a visible label on the packaging indicating specific risks and required precautions associated with the dangerous good.

Level	Component	Base	Case	Pallet
M = mandatory C = conditional - = not used	-	C	C	C

T4143 Dangerous goods hazard label number

BMS ID	3896			
Definition	A visible number indicating the specific risk and thus the required precautions associated with a dangerous goods.			
Note	In the case of dangerous goods in limited quantities, the number does not have to be visible on the package. In these cases, use the number found in the Safety Data Sheet as the information is important to your recipient.			
Level	Component	Base	Case	Pallet
M = mandatory C = conditional - = not used	-	C	C	C

T4751 Dangerous hazardous label sequence number

BMS ID	3897			
Definition	A sequence number indicating the primacy of one dangerous goods label number over another.			

Example	For example, a value of 1 would indicate that the associated hazard label number is the primary, 2 = secondary, etc.			
Level	Component	Base	Case	Pallet
M = mandatory C = conditional - = not used	-	C	C	C

Health care item information

Use this group of attributes to provide information about health care.

Level	Component	Base	Case	Pallet
M = mandatory C = conditional - = not used	-	C	C	C

T4273 Does trade item contain latex

BMS ID	1434			
Definition	An indication that the trade item has a positive latex reference on the trade item's labeling.			
Code value	true - Packaging indicates that the product contains latex false - Packaging does not indicate that the product contains latex			
Level	Component	Base	Case	Pallet
M = mandatory C = conditional - = not used	-	C	-	-

T4373 Prescription type code

BMS ID	1436			
Definition	The attribute indicates what type of prescription is required or whether it is non-prescription.			
Code value	Specify a code value according to code list "T4373 Prescription type code" see www.gs1.se/en-codelist-t4373			
Level	Component	Base	Case	Pallet
M = mandatory C = conditional - = not used	-	C	C	-

Origin

This group of attributes can be used to specify information about the trade item's country of origin.

Level	Component	Base	Case	Pallet
--------------	------------------	-------------	-------------	---------------

M = mandatory C = conditional - = not used	C	C	-	-
---	---	---	---	---

T0168 Country of origin

BMS ID	2794			
Definition	The country in which the trade item has been manufactured, expressed as an ISO code.			
Description	<p>The trade item's country of origin is the country in which its final significant processing took place.</p> <p>The attribute is required for all food and alcoholic beverages.</p> <p>Provide the trade item's country of origin according to applicable definitions and regulations.</p> <p>The attribute can be repeated if the trade item is manufactured in several countries.</p> <p>Do not use the attribute to provide information about the origin of primary ingredient(s) in a food product according to EU regulation 2018/775. Use T4202 Provenance statement for that purpose.</p>			
Code value	<p>Code value is specified according to code list T3784, see www.gs1.se/en-codelist-T3784.</p> <p>Code is specified according to ISO 3166-1 (three digit numeric).</p>			
Level	Component	Base	Case	Pallet
M = mandatory C = conditional - = not used	C	C	-	-

T4202 Provenance statement

BMS ID	2783
Definition	The geographic area from which the trade item and, if applicable, the trade item's primary ingredient(s) according to EU regulation 2018/775, originates.
Description	<p>Provide the most specific area available, for example the country, region, commune or mountain range from which the trade item originates.</p> <p>When appropriate, use the attribute to provide information about primary ingredient(s) according to EU regulation 2018/775.</p> <p>In all cases, the information must be provided exactly as it reads on the product packaging.</p> <p>Always specify the information in Swedish.</p>
Example	<p>Example of how to provide the geographic area from which the trade item originates:</p> <p>"Från Thüringen", "Från Gotland", "Bakade i Sigtuna"</p> <p>Example of how to indicate geographical origin when an ingredient or trade item comes from multiple countries:</p> <p>Honung från Slovenien 80%, Ukraina 20%.</p>

	Example of how to provide the geographic area from which the primary ingredient(s) originates: "Spenat från EU"; "Yoghurt från Sverige"; [Name of primary ingredient(s)] does not originate from [country or area of origin of the food product]			
Note	Information about the country in which the trade item has been manufactured is not given here but in T0168 Country of origin Allows for the representation of the same value in different languages, but not for multiple values.			
Level	Component	Base	Case	Pallet
M = mandatory C = conditional - = not used	C	C	-	-

Marks

This group of attributes is used to specify which type of barcode is on the package as well as other possible marks.

Level	Component	Base	Case	Pallet
M = mandatory C = conditional - = not used	-	M	M	M

T4357 Claim marked on package

BMS ID	7235			
Definition	The claim, specified by Claim type code in combination with Claim element code, that is labelled on the product package.			
Description	Use if the product package is labelled with claims specified in "T4358 Claim type code" and "T4359 Claim element code".			
Level	Component	Base	Case	Pallet
M = mandatory C = conditional - = not used	-	C	C	-

T4358 Claim type code

BMS ID	7237			
Definition	The code that states the type of claim applicable to the product. It may be used alone, or in combination with Claim Element Code to identify a specific element, such as a food ingredient, chemical compound or sustainability factor, to which the claim type applies.			
Description	The degree to which a trade item contains a specific nutrient or ingredient stated in "T4359 Claim element code".			
Code Value	Code value is specified according to code list T4358 Claim type code .			
Level	Component	Base	Case	Pallet
M = mandatory C = conditional - = not used	-	C	C	-

T4359 Claim element code

BMS ID	7233			
Definition	The code that specifies an element, such as a food ingredient, chemical compound or sustainability factor, that is subject to the claim type specified by the Claim Type Code.			
Description	The type of nutrient, ingredient, vitamin and mineral that the health claim is in reference to in "T4358 Claim type code".			
Code value	Code value is specified according to code list T4359 Claim element code .			
Level	Component	Base	Case	Pallet
M = mandatory C = conditional - = not used	-	C	C	-

T4356 Claim description

BMS ID	7239			
Definition	Free text field for any additional type of product claims like nutritional, health claims, etc.			
Example	"sockerfri"			
Level	Component	Base	Case	Pallet
M = mandatory C = conditional - = not used	-	C	C	-

T4032 Trade item date on packaging format type code

BMS ID	2334			
Definition	Code indicating the type of expiration date marked on the packaging, as governed by local rules and regulations.			
Code value	Code value is specified according to code list T4032, see www.gs1.se/en-codelist-T4032 .			
Level	Component	Base	Case	Pallet
M = mandatory C = conditional - = not used	-	C	C	C

T3362 Trade item date on packaging format name

BMS ID	2331			
Definition	Formats indicating how dates on the package is printed in plain text.			

Description	<p>The attribute describes how dates in plain text are printed on the package, and is for example used for best-before date.</p> <p>The attribute is not used if the product has unlimited shelf life, that is, is not date-marked.</p> <p>The attribute is mandatory for foods and pharmaceutical consumer units, with some exceptions.</p> <p>Yyyy Year yy Year in century y Year in decennium mm Month number mmm Month short name d Day of week (Monday = 1) dd Day of month ` ` - Space and hyphen to be included if used</p> <p>The following date information is allowed for food:</p> <ul style="list-style-type: none"> ■ day, month, year ■ day, month ■ month, year ■ year
Example	<p>Example of date specifications:</p> <ul style="list-style-type: none"> ■ Example 1: The package is marked with "30-04-02" (day-month-year). Specify "dd-mm-yy". ■ Example 2: The package is marked with "30 apr" (day-of-month month-short-name). Specify "dd mmm". <p>If the packaging is marked with a date that does not fit within the field's 10 characters, the format of the date must be shortened. Recommendation:</p>
	<ul style="list-style-type: none"> ■ Example 3: The packaging is marked "Januari 2014". Abbreviate the month name to 3 characters by entering "mmm yyyy". ■ Example 4: The packaging is marked "20-APR-2014". Delete the punctuation marks and enter "ddmmmyyyy".

Level	Component	Base	Case	Pallet
M = mandatory C = conditional - = not used	-	C	C	-

T3777 Packaging marked label accreditation code

BMS ID	2312
Definition	A label that the trade item received recognition, endorsement, certification by following guidelines by the label issuing agency.
Description	The attribute may be repeated as many times as needed for an item.
Code value	The code value is specified according to code list T3777, see www.gs1.se/en-codelist-T3777 .
Note	The packaging must be marked with the symbol specified in the attribute. For example, the code value FRAN_SVERIGE is only stated when the Från Sverige symbol is on the packaging.

Level	Component	Base	Case	Pallet
M = mandatory C = conditional - = not used	-	C	C	-

T3850 Compulsory additive label information

BMS ID	1457			
Definition	A description of any other compulsory label information on the product.			
Description	<p>Can be used if there isn't any other specific field for compulsory information. Information written in connection with the regulated product name must be typed in T3850.</p> <p>T3850 can also be used for optional information such as important consumer information or other informational text.</p> <p>For information texts and information to consumers for dietary supplements, information should be entered in T3850.</p> <p>Always specify the information in Swedish.</p> <p>Read more in the section Examples of what to specify in T4088 Ingredient statement and in T3850 Compulsory additive label information.</p>			
Example	<p>"ej ätbart korvskinn"</p> <p>"överdriven konsumtion kan ha laxerande effekt."</p> <p>"Kosttillskott bör inte användas som ett alternativ till en varierad kost och hälsosam livsstil"</p>			
Note	Allows for the representation of the same value in different languages, but not for multiple values.			
Level	Component	Base	Case	Pallet
M = mandatory C = conditional - = not used	-	C	C	-

T4272 Has batch number

BMS ID	2306			
Definition	Indication whether the base trade item is batch or lot number requested by law, not batch or lot number requested by law but batch or lot number allocated, or not batch or lot number allocated.			
Description	A batch or lot number is a manufacturer-assigned code used to identify a trade item's trade item on batch or lot. Differs from Serial Number which is a			
Code Value	<p>true - the product has a batch number</p> <p>false - the product does not have a batch number</p>			
Level	Component	Base	Case	Pallet
M = mandatory C = conditional - = not used	-	C	C	-

T4281 Sun protection factor

BMS ID	273			
Definition	A measure of Ultraviolet B (UVB) radiation protection, ranging from 1 to 90			
Description	The attribute can be used for any product that has a sun protection factor.			
Example	30			
Level	Component	Base	Case	Pallet
M = mandatory C = conditional - = not used	-	C	C	-

Data carrier

This group of attributes can be used to describe what information and type of data carrier is present on a trade item. The group is only used if the trade item is or could be marked with machine-readable information.

Level	Component	Base	Case	Pallet
M = mandatory C = conditional - = not used	-	C	C	C

T4310 Data carrier type code

BMS ID	3480			
Definition	Code indicating the type of data carrier physically present on the trade item.			
Code value	Code value is specified according to code list T4310, see www.gs1.se/en-codelist-T4310			
Level	Component	Base	Case	Pallet
M = mandatory C = conditional - = not used	-	M	M	M

T3747 Data carrier presence code

BMS ID	3479			
Definition	A code that indicates if the trade item has or could have a certain data carrier present.			
Example	ALWAYS – Trade Item always includes an AI in AIDC format. SOMETIMES – Trade Item sometimes includes an AI in AIDC format			

Code value	Code value is specified according to code list T3747, see www.gs1.se/en-codelist-T3747 .			
Level	Component	Base	Case	Pallet
M = mandatory C = conditional - = not used	-	C	C	C

Duty fee taxes

This group of attributes can be used to specify which tax and tax rate apply to the item, as well as subsidies for the item. This group is mandatory for base level items.

Level	Component	Base	Case	Pallet
M = mandatory C = conditional - = not used	-	M	C	-

T4033 Duty fee tax agency code

BMS ID	1146			
Definition	Code indicating the agency responsible for the tax code list			
Code Value	Code value is specified according to code list T4033. See www.gs1.se/en-codelist-t4033 .			
Level	Component	Base	Case	Pallet
M = mandatory C = conditional - = not used	-	M	C	-

T0194 Duty fee tax type code

BMS ID	1152			
Definition	Code which indicates the tax type.			
Code Value	Code value is specified according to code list T0194, see www.gs1.se/en-codelist-T0194 .			
Level	Component	Base	Case	Pallet
M = mandatory C = conditional - = not used	-	M	C	-

T0195 Duty fee tax rate

BMS ID	1178			
Definition	The current tax rate percentage applicable to the trade item.			
Description	<p>The tax rate is stated in percent. It is not allowed to complete the field with fill-out zeros or to complete the field with zeros after a decimal.</p> <p>The duty fee tax rate should be stated with a period (.) as a decimal point.</p>			

Example	25% is stated as 25 12% is stated as 12 6% is stated as 6 0% is stated as 0			
Note	For information on tax rates, visit the tax authority's website for the respective country.			
Level	Component	Base	Case	Pallet
M = mandatory C = conditional - = not used	-	M	C	-

Packaging hierarchy

This group of attributes is used to specify which and how many items are included in the item. This group is used for every trade item that is not at base level. Read more about how this group is used in chapter [Describing a trade item hierarchy in Trade Item Information](#).

Level	Component	Base	Case	Pallet
M = mandatory C = conditional - = not used	-	-	M	M

T4034 Quantity of children

BMS ID	199			
Definition	The number of unique next lower level trade items contained in a complex trade item.			
Description	A homogeneous trade item contains 1 GTIN at next lower level. A combined trade item contains 2 or more different GTINs at next lower level. Read more about how this attribute is used in chapter Describing a trade item hierarchy in Trade Item Information .			
Example	2			
Level	Component	Base	Case	Pallet
M = mandatory C = conditional - = not used	-	-	M	M

T4035 Total quantity of next lower level trade item

BMS ID	200			
Definition	The total quantity of next lower level trade items that this trade item contains.			
Description	Total quantity of next lower level trade item is not permitted to be changed without assigning the trade item a new GTIN (Global Trade Item Number). Read more about GS1's GTIN rules at www.gs1.org/gtinrules . Read more about how this attribute is used in chapter Describing a trade item hierarchy in Trade Item Information .			

Level	Component	Base	Case	Pallet
M = mandatory C = conditional - = not used	-	-	M	M

Trade item hierarchy

This group of attributes is repeated for every item that is included in the item. Read more about how this group is used in chapter [Describing a trade item hierarchy in Trade Item Information](#).

Level	Component	Base	Case	Pallet
M = mandatory C = conditional - = not used	-	-	M	M

T2045 Child trade item, GTIN

BMS ID	203			
Definition	Item/service included in a product hierarchy or in a mixed range or assortment product			
Description	GTIN of a trade item contained in the mixed pack or multipack. This trade item must be specified in the same message. Read more about how this attribute is used in chapter Describing a trade item hierarchy in Trade Item Information . Included item or service GTIN is not permitted to be changed without assigning the trade item a new GTIN (Global Trade Item Number). Read more about GS1's GTIN rules at www.gs1.org/gtintules .			
Level	Component	Base	Case	Pallet
M = mandatory C = conditional - = not used	-	-	M	M

T3361 Quantity of next lower level trade item

BMS ID	202			
Definition	Number of contained items in this item.			
Description	Count of the number of contained packages in the mixed pack or multipack. Read more about how this attribute is used in chapter Describing a trade item hierarchy in Trade Item Information .			
Level	Component	Base	Case	Pallet
M = mandatory C = conditional - = not used	-	-	M	M

Ingredient information

The group can be used for specifying ingredient information corresponding to the information provided for the consumer.

Level	Component	Base	Case	Pallet
M = mandatory	C	C	C	C
C = conditional				
- = not used				

T4088 Ingredient statement

BMS ID	1268
Definition	Information on the constituent ingredient make up of the product specified as one string.

Description	<p>The attribute is used to specify the ingredients as printed on the package. If the information relates to any foodstuff intended for sale in Sweden, the text must follow the rules of the EU-regulation 1169/2011.</p> <p>Allergens must be included in the ingredient statement and must be marked with uppercase.</p> <p>Example: MJÖLK.</p> <p>Do not use references that require the consumer to have the physical product in front of them because it is not apparent online, eg "För allergener, se fet stil".</p> <p>This attribute has a technical capacity of 5,000 characters, however it is recommended to use maximum 548 characters, which is the capacity most Swedish food retailers can handle.</p> <p>Recommendation for ingredient statement:</p> <ul style="list-style-type: none"> ■ 548 characters ■ If an ingredient has extra information indicated by an asterisk (*),
--------------------	--

	<p>enter any such information at the end of the ingredient statement.</p> <ul style="list-style-type: none"> ■ If "Spår av" information is stated on the packaging, this must be stated in T4088, regardless of where the information is located on the package. ■ The information "Contains source of phenylalanine" is stated in T4088. ■ If an ingredient is followed by an asterisk, the reference text must always be entered in T4088. ■ For items that contain meat, the ingredient statement should end with the percentage of meat and fat stated as "Köttthalt XX%. Fetthalt XX%". ■ Information about country of origin should be stated in "T4202 Provenance statement" ■ Indicate whether the ratio of collagen to meat protein is less than XX%, regardless of whether ingredients are specified or not. <p>Specify the information in Swedish.</p> <p>Read more in the section Examples of what to specify in T4088 Ingredient statement and in T3850 Compulsory additive label information.</p>			
Note	<p>Can be repeated with different content and in different languages.</p> <p>The attribute is applicable to food. For non-food, use "T5036 Non-food ingredient statement". For animal feed, use "T4248 Feed composition statement".</p>			
Level	Component	Base	Case	Pallet
M = mandatory C = conditional - = not used	C	C	C	C

Nutritional information

This group of attributes is used to state whether the nutritional values apply to the the product in its prepared or unprepared state, and to specify the quantity upon which the stated nutritional values are based.

Level	Component	Base	Case	Pallet
M = mandatory C = conditional - = not used	C	C	C	C

T4069 Preparation state code

BMS ID	1717
Definition	Code specifying whether the nutritional values apply to the prepared or unprepared state of the product.

Description	<p>The code value for preparation state controls the nutrient facts being referred to.</p> <p>The nutrient facts must be stated for food when selling it, but can instead, when appropriate, be stated for the foodstuff after preparation, on condition that there are sufficiently detailed instructions. It is therefore possible to only include the nutrient information for the foodstuff when it is ready to be consumed.</p>			
Example	<p>Example 1: A package contains instant mashed potato powder. The mashed potatoes are cooked by adding the powder to boiling water.</p> <ul style="list-style-type: none"> ■ State "Unprepared" when the nutritional information concerns the powder. ■ State "Prepared" when the nutritional information concerns the mashed potatoes. <p>Example 2: A bag contains baked bread.</p> <ul style="list-style-type: none"> ■ State "Unprepared" since the nutritional information concerns the baked bread. <p>Example 3: A bottle contains an undiluted fruit drink. The fruit drink is mixed by adding water.</p> <ul style="list-style-type: none"> ■ State "Unprepared" when the nutritional information concerns the undiluted fruit drink. <p>State "Prepared" when the nutritional information concerns the fruit drink when it is mixed with water.</p>			
Code value	Code value is specified according to code list T4069, see www.gs1.se/en-codelist-T4069 .			
Level	Component	Base	Case	Pallet
M = mandatory C = conditional - = not used	M	M	M	M

T4070 Daily value intake reference

BMS ID	1712			
Definition	The daily value intake base on which the daily value intake per nutrient has been based.			
Description	<p>Always specify the information in Swedish.</p> <p>RDI according to the Daily value intake reference specified here is expressed per nutrient in the attribute "T4076 Percentage of daily value intake".</p>			
Example	För en 2000 kcal diet			
	RDI			
Level	Component	Base	Case	Pallet
M = mandatory C = conditional - = not used	C	C	C	C

T3820 Nutrient basis quantity type code

BMS ID	1716			
Definition	The type of quantity contained for example measurement, serving size, or container.			
Description	<p>Nutrient basis quantity type can either be based on measurement or serving size. It can, for example, be per 100 grams, or per portion of X number of grams serving size.</p> <p>Specify the basic quantity type used in this attribute, the size in "T3824 Nutrient basis quantity" and the unit of measure in "T3780 Measurement unit code".</p>			
Example	BY_MEASURE – By measure: Per 100 gram BY_SERVING – By Serving 372 g Serving Size			
Code value	Code value is specified according to code list T3820, see www.gs1.se/en-codelist-T3820 .			
Level	Component	Base	Case	Pallet
M = mandatory C = conditional - = not used	C	C	C	C

T3824 Nutrient basis quantity

BMS ID	1714			
Definition	The basis amount that a nutrient is measured against when it is not serving size. For example, 120 gr in the case of 30 kj per 120 gr.			
Example	Per 100 grams: <ul style="list-style-type: none"> ■ T3824 Nutrient Basis Quantity: 100 ■ "T3780 Unit of measure" for Nutrient Basis Quantity : GRM – gram 			
Code value	Code value for measurement unit is specified according to code list "T3780 Measurement unit code", see www.gs1.se/en-codelist-T3780 . For "T3824 Nutrient Basis Quantity" unit choose code value: GRM - gram MLT- milliliter H87 - piece			
Level	Component	Base	Case	Pallet
M = mandatory C = conditional - = not used	C	C	C	C

T4399 Nutrient basis quantity description

BMS ID	1720			
Definition	Additional free text information needed to correctly express nutrient basis quantity for example per bottle (100 ml)..			
Description	The manufacturer's recommendation on the serving size. Always specify the information in Swedish.			
Example	per 150 g 1 kaka (19g)			
Note	Allows for the representation of the same value in different languages, but not for multiple values.			
Level	Component	Base	Case	Pallet
M = mandatory C = conditional - = not used	C	C	C	C

Nutrient facts

The group is used for specifying nutrient facts. The attributes in the group are repeated for each nutrient type.

Combined products consisting of components that do not have their own GTINs should have a single, combined nutritional declaration for all components. If the combined product consists of items that have their own GTIN, report the information separately for each item.

The group is only used if the group "Nutrient information" is used.

Level	Component	Base	Case	Pallet
M = mandatory C = conditional - = not used	C	C	C	C

T4076 Daily value intake percent

BMS ID	1731			
Definition	Percentage of daily value intake.			
Description	The percentage of daily value intake is expressed relative to "T3824 Nutrient Basis Quantity", and "T4070 Daily value intake reference". It is recommended that the percentage of daily value intake variation is not specified with a greater accuracy than whole per cent.			
Example	8% is stated as 8			
Level	Component	Base	Case	Pallet
M = mandatory C = conditional - = not used	C	C	C	C

T4073 Nutrient type code

BMS ID	1773			
Definition	Code indicating a nutrient that the product contains.			
Description	Use codes to express every nutrient specified. The code list is a selection of codes from INFOODS' code list. The selection of codes is recommended for the Swedish market. See also the EU-regulation 1169/2011 on how to specify nutrients.			
Code value	Code value is specified according to code list T4073, see www.gs1.se/en-codelist-T4073 .			
Level	Component	Base	Case	Pallet
M = mandatory C = conditional - = not used	M	M	M	M

T4075 Measurement precision code

BMS ID	1732			
Definition	Code indicating whether the specified nutrient content is exact or approximate.			
Code value	Code value is specified according to code list T4075, see www.gs1.se/en-codelist-T4075 .			
Level	Component	Base	Case	Pallet
M = mandatory C = conditional - = not used	M	M	M	M

T4074 Quantity contained

BMS ID	1734			
Definition	Measurement value indicating the amount of nutrient contained in the product.			

Example	Example 1: 42 gram <ul style="list-style-type: none"> ■ "T4074 Quantity contained": 42 ■ "T3780 Measurement unit code" for quantity contained: GRM Example 2: 430 kJ <ul style="list-style-type: none"> ■ "T4074 Quantity contained": 430 "T3780 Measurement unit code" for quantity contained: KJO			
Code Value	Code value for measurement unit to "T4074 Quantity contained" is specified according to code list "T3780 Measurement unit code", see www.gs1.se/en-codelist-T3780 . For "T4074 Quantity contained" choose one of following code values: E14 – kilocalories GRM – gram KJO – kilojoules MC – microgram MGM – milligram			
Level	Component	Base	Case	Pallet
M = mandatory C = conditional - = not used	M	M	M	M

T4407 Nutrient name on package

BMS ID	7244			
Definition	The name of the nutrient as it is listed on the fact panel on the package. Only used when the Nutrient Name on Package is different than the Nutrient Code (nutrientTypeCode). Frequently used for supplements.			
Example	"T4073 Nutrient type code": X_OMEGA_3_OTHER "T4407 Nutrient name on package": EPA+DHA			
Level	Component	Base	Case	Pallet
M = mandatory C = conditional - = not used	V	V	V	V

Allergen information

This group of attributes can be used to state information concerning allergens. Allergens are specified with the attributes "T4078 Allergen type code", "T4079 Level of containment code", and "T4088 Ingredient statement".

Level	Component	Base	Case	Pallet
M = mandatory C = conditional - = not used	-	C	C	C

T4077 Allergen statement

BMS ID	370			
Definition	Textual description on allergens.			
Description	<p>The attribute may only be used to provide information about allergens in free text.</p> <p>For food products: If the product contains several allergens that are missing in the allergen type code list, then the allergens are specified as a string using this attribute. The attribute may only be used to indicate allergens that are not present in the T4078 Allergen type code list.</p> <p>For alcohol products: Enter all allergens present in the product.</p> <p>Specify the information in Swedish.</p> <p>The Swedish Food Agency gives instructions for allergen statements, see www.slv.se.</p>			
Note	Allows for the representation of the same value in different languages, but not for multiple values.			
Level	Component	Base	Case	Pallet
M = mandatory C = conditional - = not used	-	C	C	C

Allergen

This group of attributes is stated once per allergen.

Level	Component	Base	Case	Pallet
M = mandatory C = conditional - = not used	-	C	C	C

T4078 Allergen type code

BMS ID	375			
Definition	Code indicating the type of allergen.			
Description	<p>Code stated here is not communicated to the consumer but is used as support in the supplier's and / or recipients' systems.</p> <p>The type of allergen can be specified for food, cosmetics, and other product groups in which such substances are present.</p>			
Code value	Code value is specified according to code list T4078, see www.gs1.se/en-codelist-T4078 .			
Note	<p>The attributes T4079 Level of containment code and T4078 Allergen Type code should only be provided when T4088 Ingredient statement contains information about allergens.</p> <p>If the trade item lacks an ingredient list and T4088 is not filled in, T4077 Allergen Statement should instead be used to indicate whether the product contains allergens.</p>			
Level	Component	Base	Case	Pallet

M = mandatory C = conditional - = not used	-	M	M	M
---	---	---	---	---

T4079 Level of containment code

BMS ID	376			
Definition	Code indicating the level of presence of the allergen or additive.			
Code value	Code value is specified according to code list T4079, see www.gs1.se/en-codelist-T4079 .			
Note	<p>The attributes T4079 Level of containment code and T4078 Allergen Type code should only be provided when T4088 Ingredient statement contains information about allergens.</p> <p>If the trade item lacks an ingredient list and T4088 is not filled in, T4077 Allergen Statement should instead be used to indicate whether the product contains allergens.</p>			
Level	Component	Base	Case	Pallet
M = mandatory C = conditional - = not used	-	M	M	M

Diet type

The group can be used for describing the diet or diets the product is suitable for.

Level	Component	Base	Case	Pallet
M = mandatory C = conditional - = not used	-	C	C	C

T4066 Diet type code

BMS ID	1066			
Definition	Code indicating the diet the product is suitable for.			
Description	Diet type can be specified for foods, cosmetics, and other product groups.			
Code value	Code value is specified according to code list T4066, see www.gs1.se/en-codelist-T4066 .			
Level	Component	Base	Case	Pallet
M = mandatory C = conditional - = not used	-	C	C	C

T4279 Diet type subcode

BMS ID	1067			
Definition	Indicates a set of agreements or a certificate name that guarantees the product is permitted in a particular diet.			
Description	<p>Use T4066 Diet type code to provide an overall diet type, for example "vegetarian".</p> <p>Use T4279 Diet type subcode to provide a more specific diet type belonging to the overall diet type provided in T4066 Diet type code, for example "ovo" or "lacto".</p>			
Example	Lacto-ovo			
Code value	See full list of code values in code list T4279, www.gs1.se/en-codelist-T4279 .			
Level	Component	Base	Case	Pallet
M = mandatory C = conditional - = not used	-	C	C	C

T4312 Is diet type marked on package

BMS ID	6302			
Definition	Code indicating whether the diet type is labelled on the product package.			
Description	Use this attribute when the diet type specified in "T4066 Diet type code" and/or "T4279 Diet type sub code", is labelled on the product package.			
Level	Component	Base	Case	Pallet

Preparation information

This group of attributes can be used to describe how the product has been prepared by the manufacturer and how the user can prepare the product. The manufacturer's preparation method and/or the preparation information for the user may be stated more than once (once for each preparation type).

Level	Component	Base	Case	Pallet
M = mandatory C = conditional - = not used	-	C	C	C

T4083 Preparation instructions

BMS ID	1377			
Definition	Instruction on how to prepare the product.			
Description	Textual instruction on how to prepare the product according to method stated in "T4082 Preparation type code". Specify the information in Swedish.			
Level	Component	Base	Case	Pallet
M = mandatory C = conditional - = not used	-	C	C	C

Attributes related to animal feed

Animal feeding information

Feeding directions for the trade item as it relates to different life stages of the animal to be fed.

Level	Component	Base	Case	Pallet
M = mandatory C = conditional - = not used	-	C	C	-

T4222 Targeted consumption by

BMS ID	389			
Definition	The food is intended by end consumption by this animal(s)			
Description	Read more about how the attribute is used in the separate Implementation guideline for animal feed .			
Example	DOG			
Code Value	Code value is specified according to code list T4222, see www.gs1.se/en-codelist-t4222 .			
Level	Component	Base	Case	Pallet
M = mandatory C = conditional - = not used	-	C	C	-

T4223 Feed type code

BMS ID	388			
Definition	Type of pet food or feed given to wild or domestic animals in the course of animal husbandry.			
Description	<p>Fodder refers particularly to food given to the animals (including plants cut and carried to them), rather than that which they forage for themselves. It includes hay, straw, silage, compressed and pelleted feeds, oils and mixed rations, and sprouted grains and legumes.</p> <p>Read more about how the attribute is used in the separate Implementation guideline for animal feed.</p>			
Example	To indicate that the feed is nutritionally complete, enter: COMPLETE			
Code Value	Code value is specified according to code list T4223, see www.gs1.se/en-codelist-t4223 .			
Level	Component	Base	Case	Pallet
M = mandatory C = conditional - = not used	-	C	C	-

T4250 Feed additive statement

BMS ID	5907			
Definition	List of the animal feed composition data, based on the ingredients contained in the feed, as governed by local rules and regulations.			
Description	<p>Enter additives exactly as they appear on the product packaging.</p> <p>Read more about how the attribute is used in the separate Implementation guideline for animal feed.</p>			
Example	Protein: 25, fett: 15, fibrer: 1,3, aska: 6,1, omega-3 fetter: 6, EPA/DHA: 3			
Note	Allows for the representation of the same value in different languages, but not for multiple values.			
Level	Component	Base	Case	Pallet
M = mandatory C = conditional - = not used	-	C	C	-

T4249 Feed analytical constituents statement

BMS ID	5909			
Definition	List of the analytical constituents or guaranteed analysis of the feed, based on the nutrient analysis of the finished product, as governed by local rules and regulations.			
Description	<p>Enter additives exactly as they appear on the product packaging.</p> <p>Read more about how the attribute is used in the separate Implementation guideline for animal feed.</p>			
Example	Protein: 25, fett: 15, fibrer: 1,3, aska: 6,1, omega-3 fetter: 6, EPA/DHA: 3			

Note	Allows for the representation of the same value in different languages, but not for multiple values.			
Level	Component	Base	Case	Pallet
M = mandatory C = conditional - = not used	-	C	C	-

T4248 Feed composition statement

BMS ID	5911			
Definition	List of the animal feed composition data, based on the ingredients contained in the feed, as governed by local laws and regulations.			
Description	Enter feed composition exactly as it appears on the product packaging. Read more about how the attribute is used in the separate Implementation guideline for animal feed .			
Example	Spannmål, kött & köttbiprodukter (varav 4% kyckling i beige bitar), vegetabiliska biprodukter, oljor & fetter, vegetabiliskt proteinextrakt, mineraler, grönsaker (4% morötter i orange bitar, 4% ärtor i gröna bitar)			
Note	Allows for the representation of the same value in different languages, but not for multiple values.			
Level	Component	Base	Case	Pallet
M = mandatory	-	C	C	-
C = conditional - = not used				

T4251 Feeding instructions

BMS ID	5913			
Definition	All instructions describing how (e.g. in which amounts or how often) the animal should be fed based on the age, weight, diet or other variables, expressed as free text. Information provided shall be identical to that on the label or pack.			
Description	Read more about how the attribute is used in the separate Implementation guideline for animal feed .			
Example	"Ge en vuxen hund den rekommenderade dagliga utfodringsmängden en gång per dygn. Justera mängden efter din hunds aktivitetsnivå, ras och ålder. Foder som blir över kan kylas upp till 3 dagar. Förvaras svalt."			
Note	Allows for the representation of the same value in different languages, but not for multiple values.			
Level	Component	Base	Case	Pallet
M = mandatory C = conditional - = not used	-	C	C	-

T4410 Animal food type code

BMS ID	7091
---------------	------

Definition	The code that describes the shape or consistency of the animal food product.			
Description	Read more about how the attribute is used in the separate Implementation guideline for animal feed .			
Example	STICK - Stick			
Code Value	Code value is specified according to code list T4410 Animal food type code .			
Level	Component	Base	Case	Pallet
M = mandatory C = conditional - = not used	-	C	C	-

T4409 Animal targeted health condition code

BMS ID	7096			
Definition	The code that identifies any health conditions that the animal product addresses.			
Description	Read more about how the attribute is used in the separate Implementation guideline for animal feed .			
Example	INDOOR - Inomhus			
Code Value	Code value is specified according to code list T4409 Animal targeted health condition code .			
Level	Component	Base	Case	Pallet
M = mandatory C = conditional - = not used	-	C	C	-

T4424 Animal Target Size Code

BMS ID	8751			
Definition	The code, as defined by the seller, that describes the generic size of the animal, in relation to its species, for product usage			
Description	Read more about how the attribute is used in the separate Implementation guideline for animal feed .			
Example	SMALL-Small			
Code Value	Code value is specified according to code list T4424 Animal Target Size Code .			
Level	Component	Base	Case	Pallet
M = mandatory C = conditional - = not used	-	C	C	-

T4425 Feed Life Stage Code

BMS ID	8749			
Definition	The code, as defined by the seller, that describes the generic life stage(s) of the animal for product usage.			
Description	Read more about how the attribute is used in the separate Implementation guideline for animal feed .			
Example	SENIOR-Senior			
Code Value	Code value is specified according to code list T4425 Feed Life Stage Code .			
Level	Component	Base	Case	Pallet
M = mandatory C = conditional - = not used	-	C	C	-

Animal feeding

Specific feeding directions for the trade item as it relates to different life stages of the animal to be fed.

Level	Component	Base	Case	Pallet
M = mandatory C = conditional - = not used	-	C	C	-

T4208 Feed life stage

BMS ID	399			
Definition	Identifies the life-stage of the animal for which a trade item has been designed for.			
Description	Read more about how the attribute is used in the separate Implementation guideline for animal feed .			
Example	Vuxen 5-8 år			
Note	Allows for the representation of the same value in different languages, but not for multiple values.			
Level	Component	Base	Case	Pallet
M = mandatory C = conditional - = not used	-	C	C	-

T4209 Maximum weight of animal being fed

BMS ID	401
---------------	-----

Definition	The highest weight (in a weight range) of the animal to be fed by the trade item. This value qualifies the quantity of feed for the feed life-stage.			
Description	Read more about how the attribute is used in the separate Implementation guideline for animal feed .			
Example	80 kilogram			
Code Value	Code value for measurement unit is specified according to code list "T3780 Measurement unit code", see www.gs1.se/en-codelist-T3780 . For "Maximum weight of animal being fed", value choose code value: KGM – kilogram			
Level	Component	Base	Case	Pallet
M = mandatory C = conditional - = not used	-	C	C	-

T4210 Minimum weight of animal being fed

BMS ID	403
Definition	The lowest weight (in a weight range) of the animal to be fed by the trade item. This value qualifies the quantity of feed for the feed lifestage.

Description	Read more about how the attribute is used in the separate Implementation guideline for animal feed .
--------------------	--

Example	1 kilogram			
Code Value	Code value for measurement unit is specified according to code list "T3780 Measurement unit code", see www.gs1.se/en-codelist-T3780 . For "T4210 Minimum weight of animal being fed" value choose code value: KGM – kilogram			
Level	Component	Base	Case	Pallet
M = Mandatory C = Conditional - = Not used	-	C	C	-

Animal feeding detail

Detail directions for feeding amount of the trade item as it relates to different life stages of the animal to be fed.

Level	Component	Base	Case	Pallet
M = mandatory C = conditional - = not used	-	C	C	-

T4212 Feeding amount

BMS ID	416
Definition	The amount of feed which is specified for the feed life-stage and qualified by the weight of animal being fed.

Description	Read more about how the attribute is used in the separate Implementation guideline for animal feed .			
Example	50 gram			
Code Value	Code value for measurement unit is specified according to code list "T3780 Measurement unit code", see www.gs1.se/en-codelist-T3780 .			
Level	Component	Base	Case	Pallet
M = Mandatory C = Conditional - = Not used	-	C	C	-

T4214 Maximum feeding amount

BMS ID	420			
Definition	The maximum amount of feed which is specified for the feed life-stage and qualified by the weight of animal being fed.			
Description	Read more about how the attribute is used in the separate Implementation guideline for animal feed .			
Example	85 gram			
Code Value	Code value for measurement unit is specified according to code list "T3780 Measurement unit code", see www.gs1.se/en-codelist-T3780 .			
Level	Component	Base	Case	Pallet
M = Mandatory C = Conditional - = Not used	-	C	C	-

T4215 Minimum feeding amount

BMS ID	422			
Definition	The minimum amount of feed which is specified for the feed life stage and qualified by the weight of animal being fed			
Description	Read more about how the attribute is used in the separate Implementation guideline for animal feed .			
Example	38 gram			
Code Value	Code value for measurement unit is specified according to code list "T3780 Measurement unit code", see www.gs1.se/en-codelist-T3780 .			
Level	Component	Base	Case	Pallet
M = Mandatory C = Conditional - = Not used	-	C	C	-

T4216 Recommended frequency of feeding

BMS ID	424			
Definition	How frequently it is recommended to feed an animal the quantity of feed within a time period for the specified feed life-stage.			
Description	Read more about how the attribute is used in the separate Implementation guideline for animal feed .			
Example	2 intag per dag 2 portioner per dag			
Note	Allows for the representation of the same value in different languages, but not for multiple values.			
Level	Component	Base	Case	Pallet
M = mandatory C = conditional - = not used	-	C	C	-

How to fill in Trade item information

This section contains examples that show how Trade item information should be filled in for different contexts.

Shelf-edge labels

Shelf-edge labels help the consumer compare different package sizes and brands. This data comes directly from Trade Item Information and it is therefore essential that it be correct. If the item name is wrong on the shelf-edge label, for example, it can be difficult to find the right item on the shelf. The consumer may then choose another item.

The following attributes are fetched from Trade Item Information:

- **T3337 Description short:** Describes the function of an item and how it is to be used. It may not contain the brand name or size. Example: Breakfast cereals or Washing powder.
- **T0143 Brand name:** An identifier that distinguishes your products from others
- **T4360 Descriptive size dimension:** The size printed on the package, for example 750 g or 1.5 l
- **T0147 Price comparison measurement:** Used to calculate the comparative price

Price is set by the store and is not fetched from Trade Item Information.

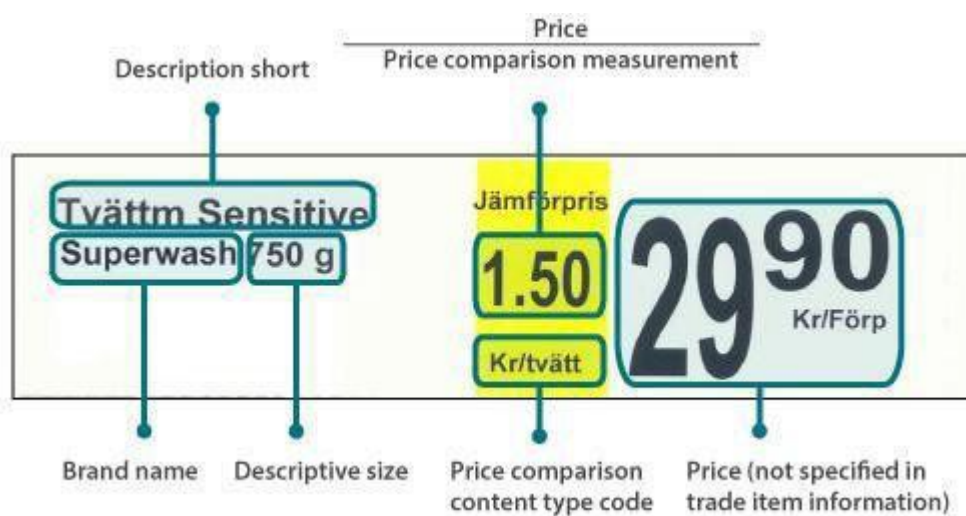

Figure 1 The figure shows an example on how information for a shelf-edge label is fetched from Trade Item Information.



Figure 2 For this washing powder package, the Description short is "Tvättm Sensitive", the Brand name is "Superwash" and the Descriptive size is 750 g.

Description short

Description short must not contain the brand name or size. If brand name and/or article size is stated in Description short, these attributes will be repeated unnecessarily on the label.



Figure 3 The figure shows a shelf-edge label where Brand name and Descriptive size are included in the Description short attribute. This means that the attributes will be repeated unnecessarily on the label.

Comparative price

Comparative price is calculated using price and the T0147 Price comparison measurement as follows:

$$\text{Comparative price} = \frac{\text{Price}}{\text{Price comparison measurement}}$$

Note that the store sets the price; it is not fetched from Trade Item Information.

Example of comparative price

The supplier has stated in Trade Item Information that a package of washing powder will provide 20 washes:

- **T0147 Price comparison measurement** = 20
- **T3780 Measurement unit code** = PCE (pieces)
- **T0145 Price comparison content type code** = PER_WASH
- **Price** = 29.90 SEK/package

$$\text{Comparative price} = \frac{29.90}{20} = 1.50 \text{ SEK/wash}$$

Trade Item Information for items of varying weight

For items with varying dimensions such as meat, fish, cheese, fruit and vegetables, where the quantity of products in a package varies and the price varies depending on quantity, Trade Item Information is given as follows:

- **T0186 Is trade item a variable unit:** In Trade Item Information this attribute is set to true to show that the item is variable-measure. The attribute is a true/false indicator and is mandatory at all item levels since some items, for example cheese, can have a variable weight at the base unit level but a fixed weight at the case level.
- **T0154 Trade item, GTIN:** A consumer unit with a variable weight is numbered with a variable measure number. Since a GTIN is always 14 digits in Trade Item Information, the 13-digit code should be padded with a leading zero. When a variable-measure number is used in Trade Item Information, the four digits showing the price in crowns or the weight in kilograms are replaced by

four zeros and the check digit is recalculated.

Note that it is only the consumer unit, at the base unit level of the item hierarchy, that is numbered with a variable-measure number. Items at the case level and pallet level must not be numbered with a variable measure number, but with a GTIN. Use the following [link](#) to read more how to number consumer packages, cases and pallets with variable weight.

- **T4017 Trade item measurements, width; T4019 Trade item measurements, height; T4018 Trade item measurements, depth; T4020 Trade item gross weight and T0082 Net content:** Measure and weigh several units to determine an average value for the item's dimensions and use these in Trade Item Information.

Measurement guide for selected code values in T4362 Size type code

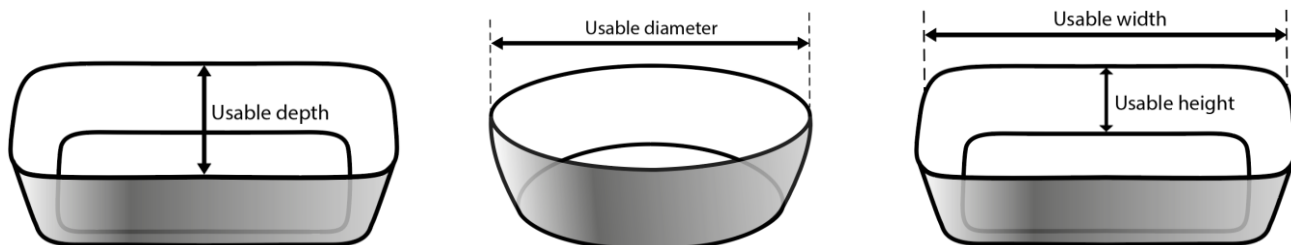

Usable depth: Measurement of the distance from the front to the back inner rims of a product.

Usable diameter: Diameter of the inner rims of a product.

Usable height: Measurement of the distance from the internal highest point of a product to its internal bottom.

Usable width: Measurement of the distance from the left to the right inner rims of a product.

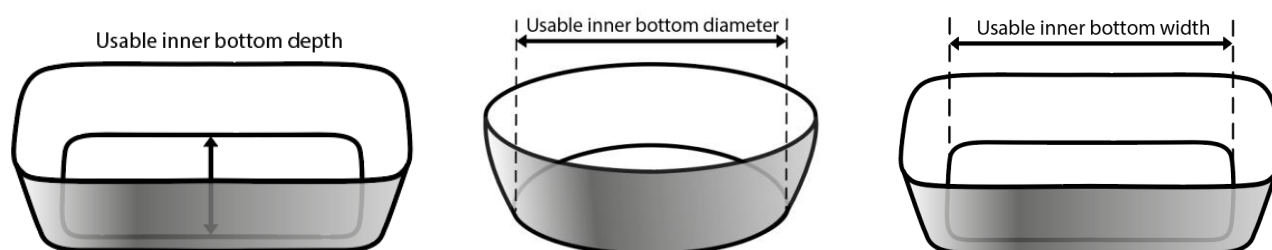

Usable inner bottom depth: Measurement of the distance from the front to the back of the bottom inner rims of a product.

Usable inner bottom diameter: Diameter of the bottom inner rims of a product.

Usable inner bottom width: Measurement of the distance from the left to the right bottom inner rims of a product.

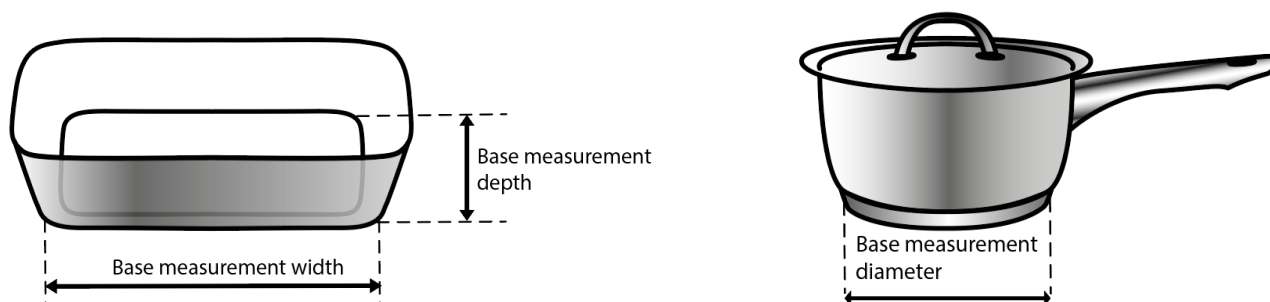

Base measurement depth: Measurement from the front to the back of the outer base of the product.

Base measurement diameter: Diameter of the product's outer base.

Base measurement with: Measurement from the left to the right of the outer base of the product.

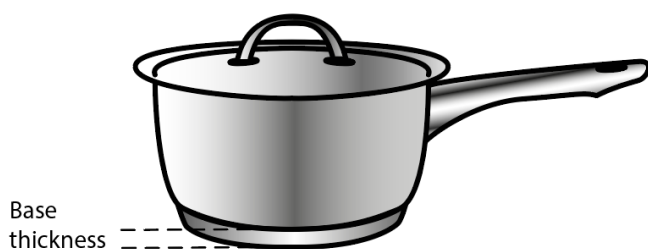

Base thickness: Measurement of the thickness of a products outer base.

Trade Item Information for books and audiobooks

Trade Item Information for books is recorded as follows:

- **T1124 Information provider of trade item, GLN:** GLN for the order recipient, that is, the party from whom the item is ordered. Can be a trading partner or distributor.
- **T0143 Brand name:** Author's name (last name, first name)
- **T0018 Functional name:** Title and publisher or imprint separated with "/"
- **T3337 Description short:** Book title; may be shortened to fit
- **T4360 Descriptive size dimension:** Type of binding (hardback/paperback/carton/audiobook)
- **T4017 Trade item measurements, width; T4019 Trade item measurements, height; T4018 Trade item measurements, depth:** The dimensions of a book are defined by the front of the book.

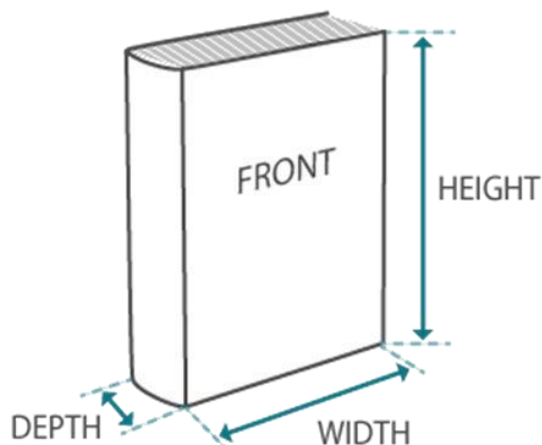

Figure 4 The dimensions of a book are defined by the front of the book.

Trade item levels in a trade item hierarchy

A trade item hierarchy shows, for example, which consumer units are contained in a case, or which cases are contained on a pallet. The buyer needs information about the trade items at each level of the trade item hierarchy. Consequently, Trade Item Information must describe the trade items at each level of the trade item hierarchy.

There are three possible levels in a trade item hierarchy:

- Base level:** The lowest level of a trade item hierarchy. A trade item at base level contains no items identified with a GTIN. A base level item is always contained in another trade item, which can be at case level or pallet level. **Examples:** A bottle of mineral water or shampoo, or a bucket for the food service industry.
 - Case level:** The middle level of a trade item hierarchy. A trade item at case level contains other trade items and is also itself contained in a trade item. A case-level item can contain items at base level or other case level items. Note that there may be several case-level items in a hierarchy. **Examples:** A box with six bottles of shampoo, a six-pack of mineral water, or a box containing four six-packs of mineral water.
- The case level is not always used, for example when the trade item at base level is large. An example is bags of charcoal that are displayed on pallets directly in the store
- Pallet level:** The highest level of a trade item hierarchy. A trade item at pallet level contains other items but is not itself contained in another trade item. **Examples:** A pallet of boxes containing bottles of shampoo or mineral water.

Each item at the different levels is given a GTIN. Trade Item Information is sent for every GTIN, since they have different attributes, such as different dimensions. Using the item levels, it is easy to describe an item hierarchy.

Summary:

- If the hierarchy consists of only one item level, for example a washing machine, the hierarchy consists of only one item at base level.
- If the hierarchy consists of two item levels, it consists of one item at base level and one item at top level, even if the top level is not a pallet or equivalent.
- If the hierarchy consists of three or more item levels, it consists of one item at base level, one item at top level and one or more levels at case level.

Example 1. A pallet of boxes containing bottles of shampoo

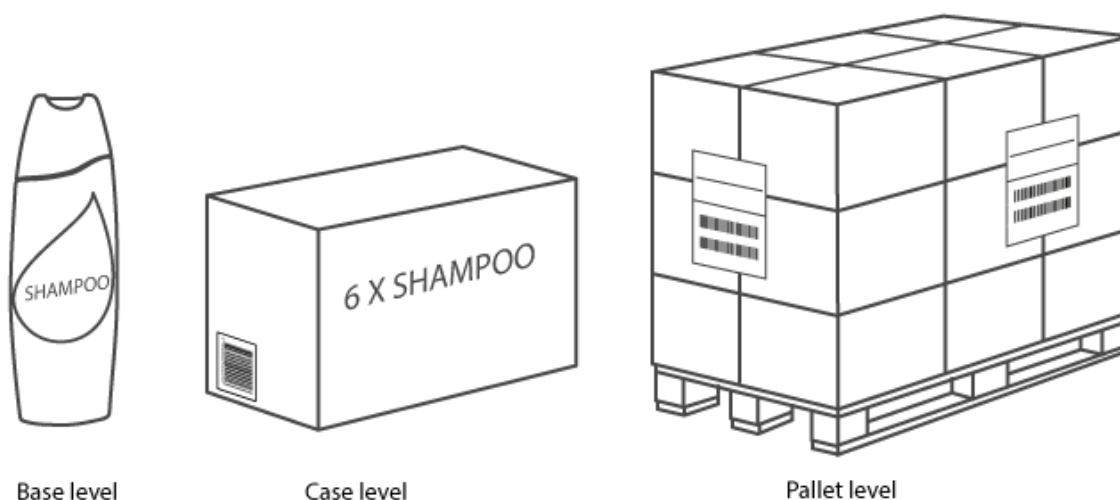

Figure 5 Example of a trade item hierarchy consisting of one base level, one case level and one top level.

Example 2. A pallet of boxes containing 6-packs of mineral water

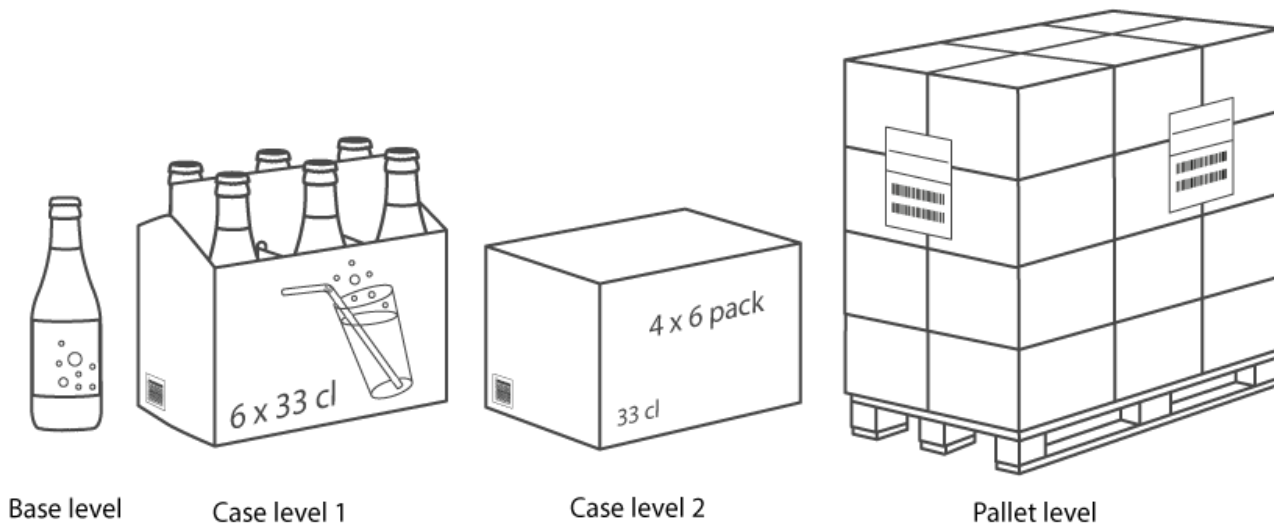

Figure 6 Example of a trade item hierarchy consisting of one base level, two case levels and one top level.

Example 3. Loose items – A pallet with boxes of apples

Apples sold by weight packed in a box

- **Base level:** Box of apples
- **Case level:** No case level if the boxes are on a pallet
- **Pallet level:** Pallet with a number of boxes

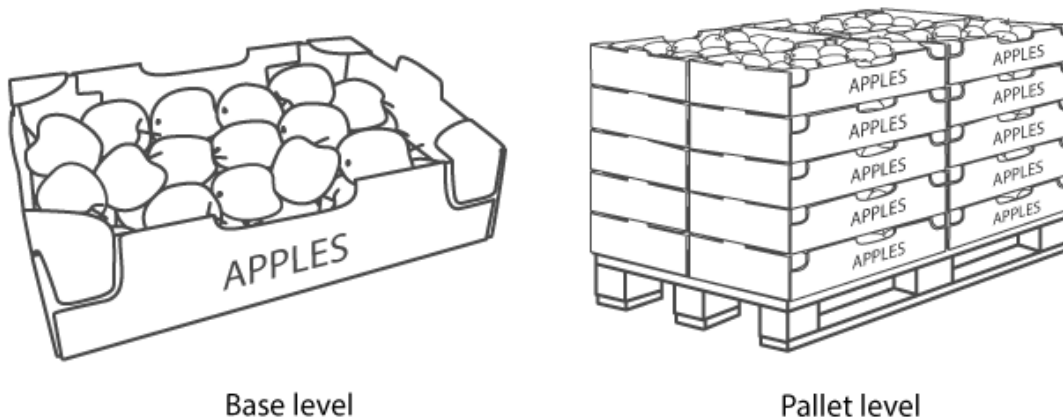

Figure 7 The base-level item is the box of apples and the top-level item is the pallet.

Baking potatoes sold individually, packed in a box

- **Base level:** One unpacked baking potato
- **Case level:** Box of baking potatoes

- **Pallet level:** Pallet with a number of boxes

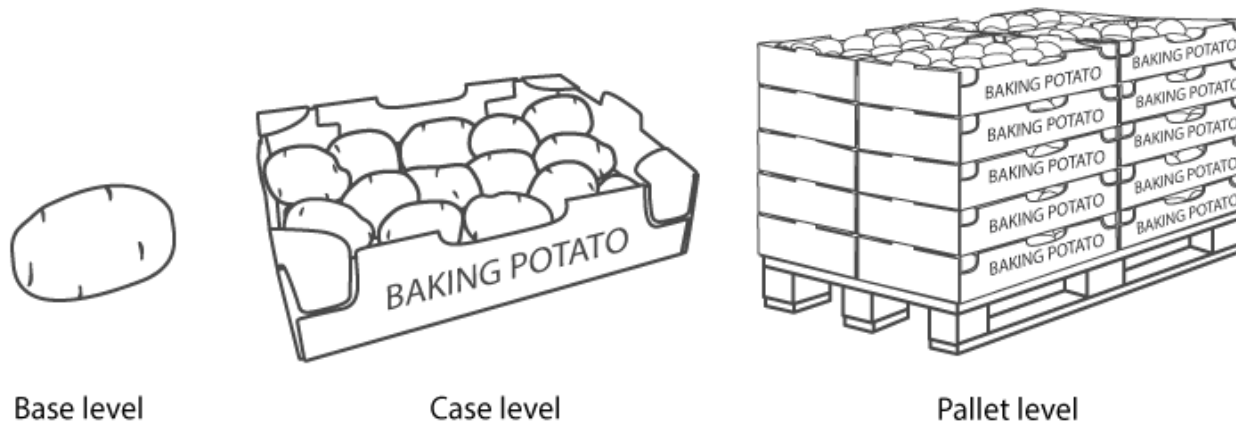

Figure 8 The base-level item is the unpacked baking potato, the case-level item is the box and the pallet-level item is the pallet.

Example 4. A display pallet with cat food

A display pallet often consists of consumer units in opened outer packages.

- **Base level:** One consumer unit of cat food
- **Case level:** No case level
- **Pallet level:** Display pallet with consumer units of cat food in opened outer packages

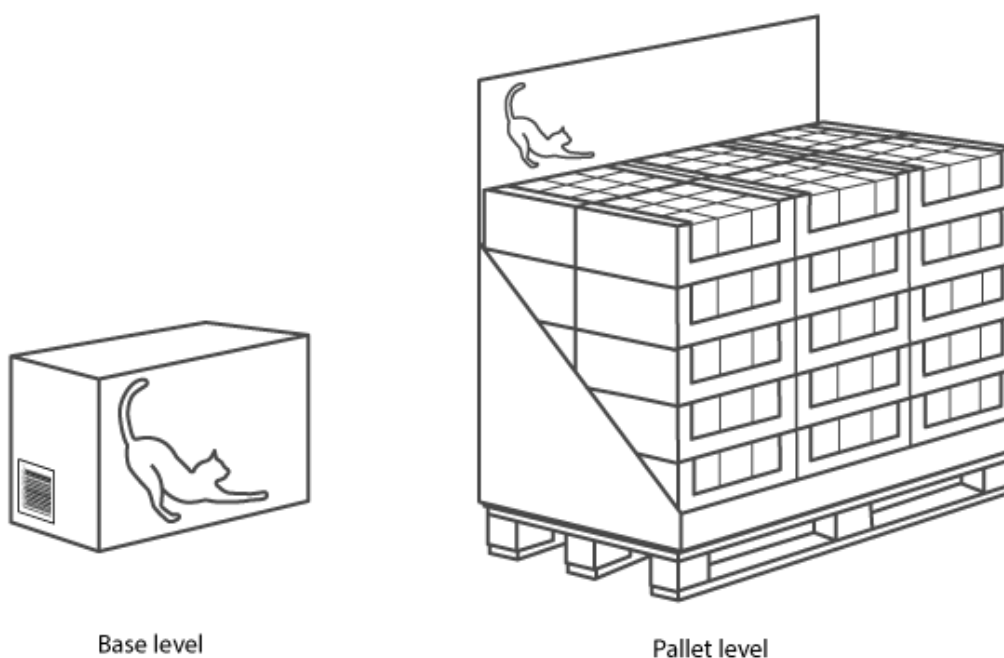

Figure 9 The base-level item is the consumer unit of cat food and the pallet-level item is the display pallet.

Item	T4010 Trade item unit descriptor code	T2045 Child trade item, GTIN	T3361 Quantity of next lower level trade item
Display pallet	Pallet	Consumer unit of cat food	324
Consumer unit of cat food	Base	-	-

Example 6. A brewery pallet

A brewery pallet consists of a full pallet with two half pallets on it. On each half pallet are two trays holding 24 bottles each. Four layers of trays and bottles are stacked on top of each other. At the top of each stack is an empty tray that locks the upper layer of bottles in place. The bottles, trays and pallets have deposits which must be entered in Trade Item Information. Each item can have information on one or more deposits. Each deposit can be associated with a certain quantity.

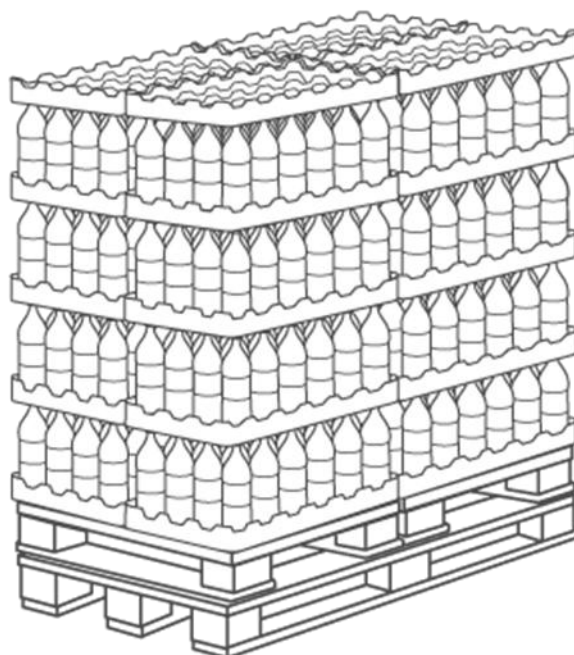

Figure 10 A brewery pallet consists of a full pallet with two half pallets on it.

The item hierarchy consists of three levels:

Pallet level

- The pallet level is the full pallet
- Dimensions and weight include the full pallet's height and weight
- Packaging type: pallet
- If a returnable full pallet with deposit is used, the deposit code for a returnable full pallet is given

Case level

- The case level is the half pallets with the two stacks
- For a mixed pallet, the item hierarchy has several items at case level
- Dimensions and weight include the half pallet's height and weight

- Packaging type: pallet
- If a returnable half pallet with deposit is used, the deposit code for a returnable half pallet is given
- The case-level item also includes the deposit for the 10 trays on each half pallet

Base level

- The lowest level of the item hierarchy is the base level, which in this case is a 1½ liter PET- bottle with beverage
- For a mixed pallet, the item hierarchy has several items at base level
- Deposit code for 1½ liter PET is given

This is how item hierarchies with deposits look for a homogeneous and mixed pallet, respectively:

Example 1. Trade item hierarchy for a homogeneous pallet

Item	T4010 Trade item unit descriptor code	T2045 Child trade item, GTIN	T3361 Quantity of next lower level trade item	T0148 Returnable package deposit identification / T4125 Returnable assets contained quantity
Full pallet	Pallet level	Half pallet	2	Deposit code for returnable full pallet / 1
Half pallet	Case level	Bottle	192	Deposit code for returnable half pallet / 1
Bottle	Base level	-	-	Deposit for PET 1½ l / 1

Example 2 Trade item hierarchy for a mixed pallet

Item	T4010 Trade item unit descriptor code	T2045 Child trade item, GTIN	T3361 Quantity of next lower level trade item	T0148 Returnable package deposit identification / T4125 Returnable assets contained quantity
Full pallet	Pallet level	Half pallet A Half pallet B	1 1	Deposit code for returnable full pallet / 1
Half pallet A	Case level	Bottle A	192	Deposit code for returnable half pallet / 1 Deposit code for tray /10
Half pallet B	Case level	Bottle B	192	Deposit code for returnable half pallet / 1 Deposit code for tray /10
Bottle A	Base level	-	-	Deposit for PET 1½ l / 1
Bottle B	Base level	-	-	Deposit for PET 1½ l / 1

Describing a trade item hierarchy in Trade Item Information

A whole trade item hierarchy is described in Trade Item Information. This includes a description of every contained item at base, case, and pallet level, and their relationship to one another. For each trade item at pallet and case levels, items contained at the next lower level of the hierarchy must be specified.

Example 1. An outer case with three different types of bottles

An outer case consisting of three different types of bottles:

- Bottle red (GTIN 1), 2 pieces
- Bottle blue (GTIN 2), 4 pieces
- Bottle green (GTIN 3), 3 pieces

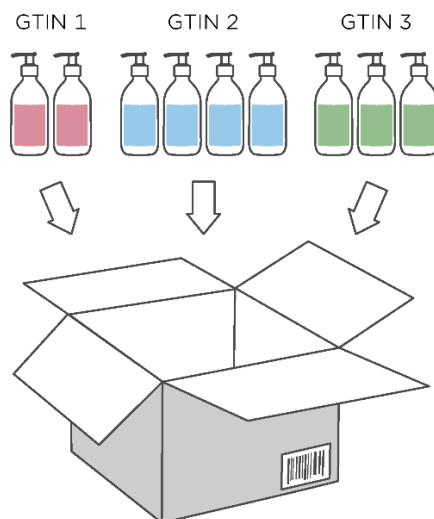

Figure 11 An outer case consisting of three different types of bottles.

The trade item hierarchy for the outer case is described in the groups Packaging hierarchy and Trade item hierarchy as follows:

- Packaging hierarchy
 - **T4034 Quantity of children** = 3 (GTIN 1 + GTIN 2 + GTIN 3)
 - **T4035 Total quantity of next lower level trade item** = 9 (2 + 4 + 3)
- Trade item hierarchy
 - **T2045 Child trade item, GTIN** = GTIN1
 - **T3361 Quantity of next lower level trade item** = 2
 - **T2045 Child trade item, GTIN** = GTIN2
 - **T3361 Quantity of next lower level trade item** = 4
 - **T2045 Child trade item, GTIN** = GTIN3
 - **T3361 Quantity of next lower level trade item** = 3

Example 2. A box containing 6 bottles of shampoo

A box contains six bottles of shampoo (GTIN 1). For the homogenous case the hierarchy is described as follows:

- Packaging hierarchy
 - **T4034 Quantity of children** = 1 (GTIN 1)
 - **T4035 Total quantity of next lower level trade item** = 6
- Trade item hierarchy
 - **T2045 Child trade item, GTIN** = GTIN1
 - **T3361 Quantity of next lower level trade item** = 6



Figure 12 A box contains 6 bottles of glue.

Consumer unit, orderable unit and/or despatch unit

A trade item can have a number of attributes related to how it is intended to be sold and distributed at different stages of the supply chain. Any trade item can have attributes indicating that it is a consumer unit, an orderable unit, or a despatch unit.

- **Consumer unit:** The trade item is intended to be sold to a consumer or end user at point-of-sale.
- **Orderable unit:** The trade item is ordered from the supplier by a wholesaler, store, or similar. Every trade item hierarchy contains an orderable unit. In some cases there can be several orderable units in the same hierarchy.
- **Despatch unit:** The trade item, usually a pallet, which is physically delivered from the supplier to the customer. There is always at least one item that is a despatch unit in a hierarchy. Usually the pallet level item is the despatch unit, but if the trade item hierarchy consists of only a base level, the base level is the despatch unit.

Summary:

Note that the same trade item can have more than one of these attributes.

- An item that is a consumer unit can also be orderable (for physically large consumer units there may be no case-level item).
- An orderable unit can also be a despatch unit (for example a display pallet).

Example 1. A pallet of boxes of bottles of shampoo

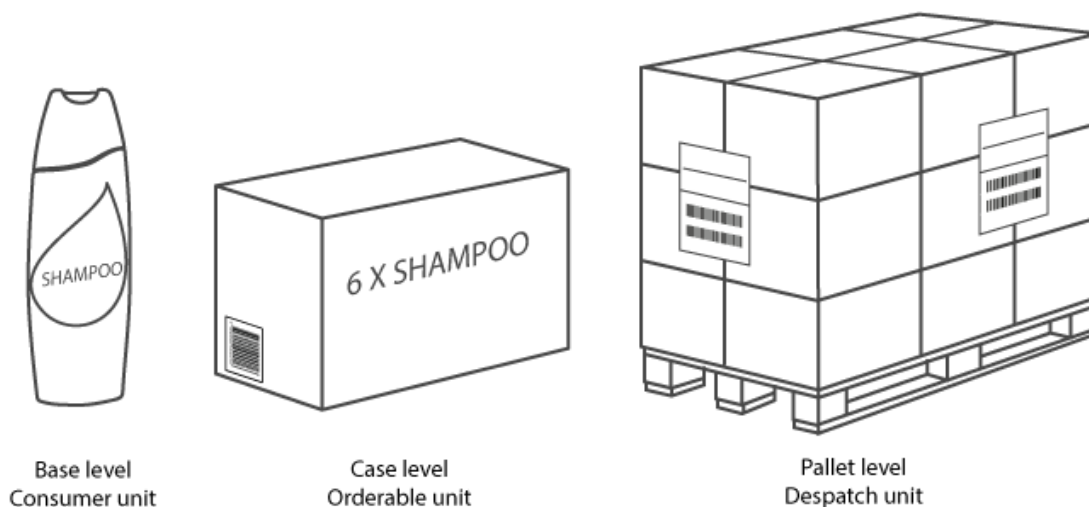

Figure 13 A consumer unit, an orderable unit and a despatch unit in a trade item hierarchy consisting of a base level, a case level, and a logistic level.

Example 2. A pallet of boxes containing 6-packs of mineral water

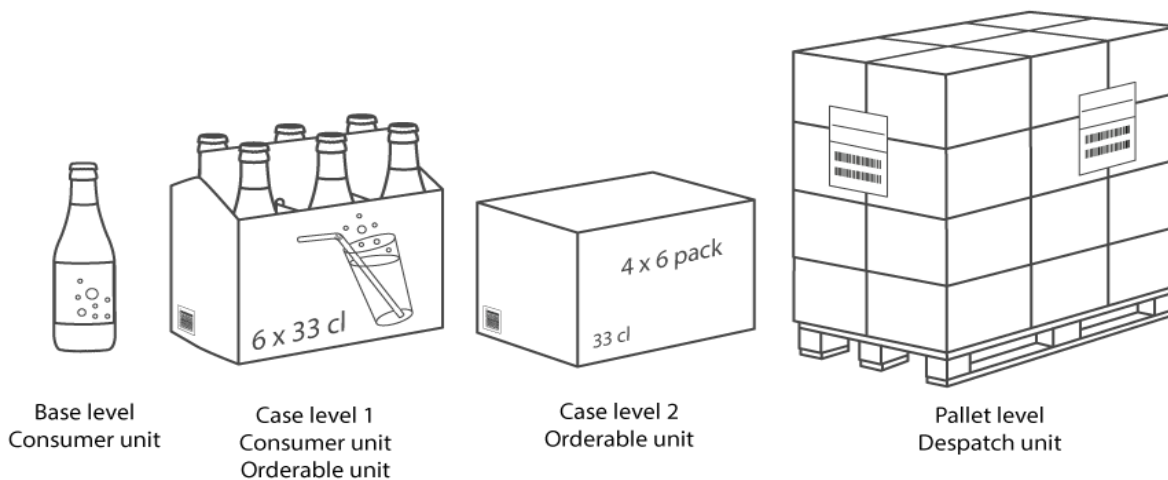

Figure 14 This trade item hierarchy with two case levels features two consumer units and two orderable units. The trade item at the first case level is both a consumer unit and an orderable unit.

Example 3. A display pallet of cat food

A display pallet often consists of consumer units in opened outer packages. In the trade item hierarchy, the consumer unit is the base level and the display pallet is the orderable and logistic unit at pallet level.

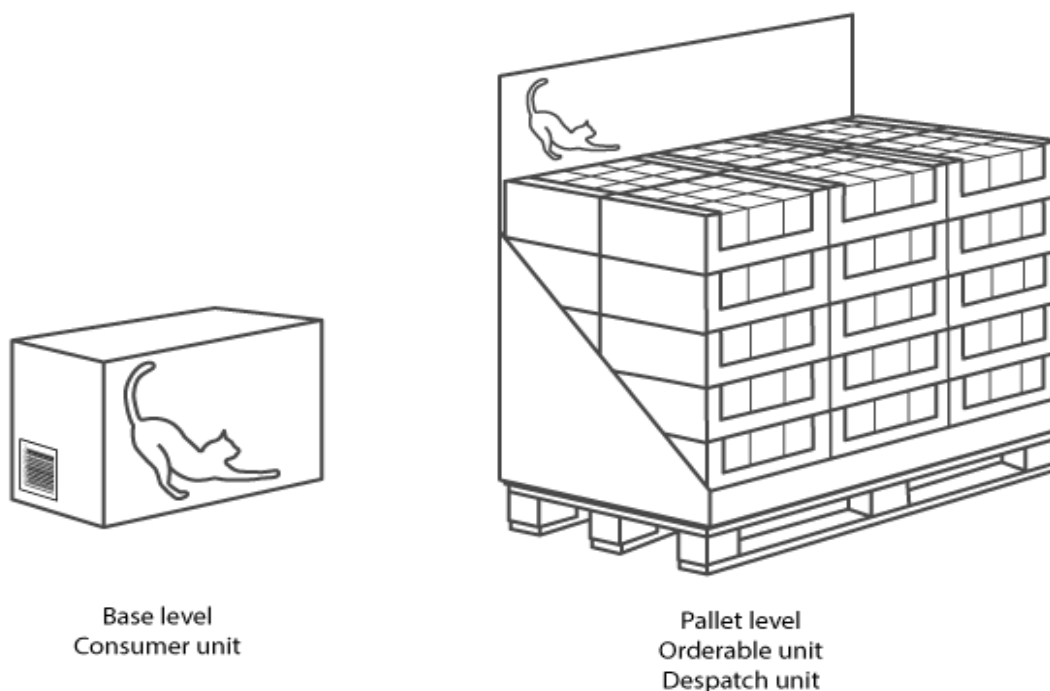

Figure 15 In this trade item hierarchy consisting of a base level and a pallet level, the trade item at pallet level is both an orderable unit and a despatch unit.

Seasonal goods

Seasonal items are specified by stating the period during which an item is orderable using Start availability date time and End availability date time. If the season is to be changed, the new season is sent as Trade Item Information with the new dates.

An example is given below of a seasonal item which is launched, available for three seasons, and then removed from the product range.

Season 1:

- **T0153 Document command:** New item
- **T4727 Start availability date time:** 2015-10-15
- **T4726 End availability date time:** 2015-12-27

Season 2:

- **T0153 Document command:** Change
- **T4727 Start availability date time:** 2016-10-14
- **T4726 End availability date time:** 2016-12-27

Season 3:

- **T0153 Document command:** Change
- **T4727 Start availability date time:** 2017-10-14
- **T4015 Discontinued date time:** 2017-12-27

Package type and deposit for Svenska Retursystem pallets

For items loaded onto a Svenska Retursystem pallets, Packaging type code, Platform type code and Returnable package deposit identification must be populated. When Validoo Item carries out its validations the load device weight given in the code list is included in the gross weight. In the event that different standard weights are given in the code lists for Platform type and Returnable package deposit, the weight from Returnable package deposit is used.

	T0137 Packaging type code	T2244 Platform type code	T0148 Returnable package deposit identification
SRS returnable half pallet	PX-pallet	10 - ISO 0-pallet	7350000486100
SRS returnable half pallet (brewers)	PX-pallet	10 - ISO 0-pallet	7350000486117
SRS/Paletten black returnable full pallet	PX-pallet	11 - ISO 1-pallet	7350000486308
SRS/Paletten grey returnable full pallet	PX-pallet	11 - ISO 1-pallet	7350000486315

For items with one of Svenska Retursystem's boxes as the packaging type, "T0137 Packaging type code" should be set to CR – Crate and "T0148 Returnable package deposit identification" to the appropriate box type.

For pallets that do not carry a deposit, Packaging type code and Platform type code should be provided. For example, for a single-use half pallet set "T0137 Packaging type code" to PX – Pallet and "T2244 Platform type code" to 10 – ISO 0-pallet.

Trade Item Information to comply with CLP regulation

The CLP regulation specifies how dangerous chemical products must be classified and labelled. The following Trade Item Information attributes are used to fulfill regulatory requirements concerning information on dangerous properties of products and how to protect yourself and the environment:

- T5044 GHS Signal words code
- T5047 Hazard statements code
- T5048 Hazard statements description
- T5049 Precautionary statements code
- T5050 Precautionary statements description

Example: A dangerous chemical product is labelled according to the figure below.

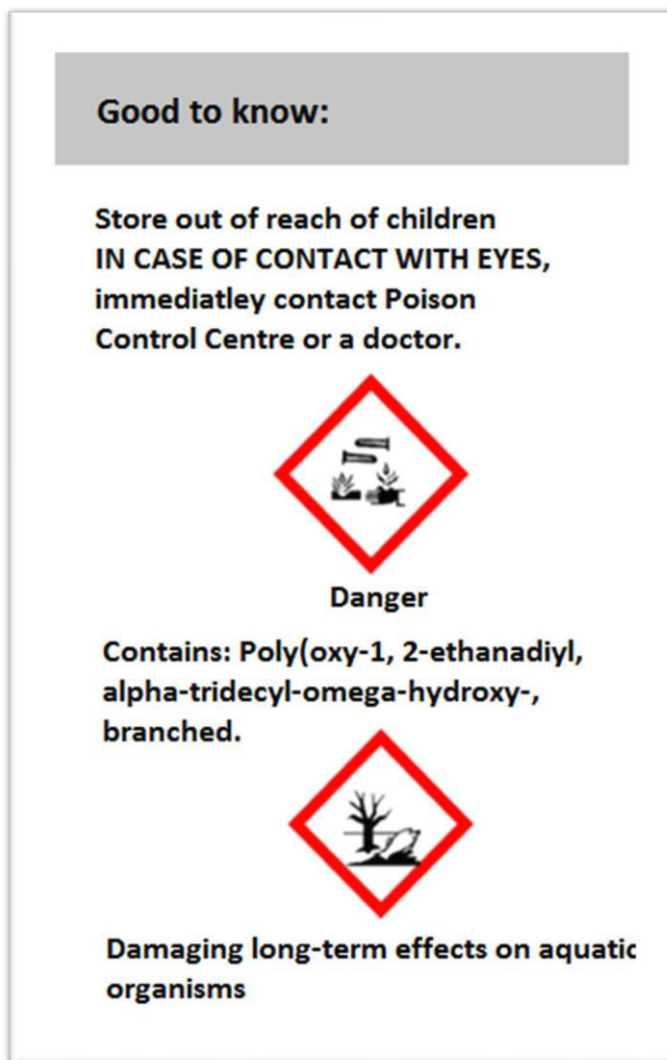

Figure 17 Example of a label on a dangerous chemical product

The information is specified in the Trade Item Information as follows:

Attribute	Information
T5044 GHS Signal words code	Danger
T5047 Hazard statements code	H412
T5048 Hazard statements description	Damaging long-term effects on aquatic organisms
T5049 Precautionary statements code	P102
T5050 Precautionary statements description	Store out of reach of children
T5049 Precautionary statements code	P305
T5050 Precautionary statements description	IN CASE OF CONTACT WITH EYES

T5049 Precautionary statements code	P310
T5050 Precautionary statements description	Immediately contact Poison Control Centre or a doctor. Contains: Poly(oxy-1, 2-ethanediyl), alpha-tridecyl-omega-hydroxy-, branched.

Application Instructions for Components

This help section aims to make it easier for you to share component information.

Components are used for composite trade items whose unique components or constituents are not labeled with EAN-13 barcode and GTIN. What determines whether you should enter Trade Item Information at base level or on a component is whether there is unique information per component on the trade item's packaging.

If it is unclear whether the information is unique to a component, you should populate the information at the trade item level. If the trade item has only one unique component, you should not use the component feature; you should share all information at trade item level.

To illustrate the above in a simple and clear way, we use a composite trade item containing three different types of sausages. See picture below.

Example: Trade item with three different types of sausage

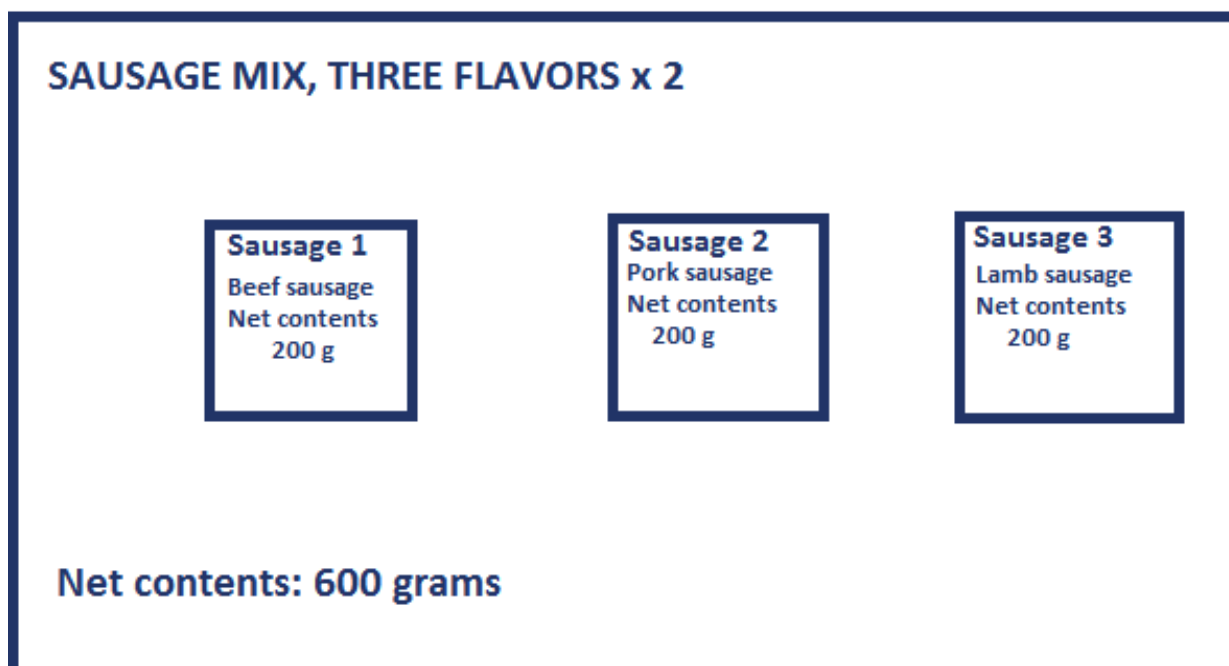

There are three different types of sausages in the composite trade item package. There are two pieces of each type.

For the sake of simplicity, the unique component information on the packaging is that each type has a net content of 200 grams. The composite trade item in its entirety at base level has a net content of 600 grams.

The information is specified in the Trade Item Information as follows. We start with the class "Trade Item Components", which is an overall description of how many components and how many types of components are included.

Attribute or class	Information
Trade Item Components	

T3832 Total quantity of components	6
T3833 Number of unique components	3

Information for each variety is then created by repeating the Component class:

Class Component (Repeated per unique Component)	(Sausage 1)
T3834 Component number	1
T3836 Component identification	111
T3837 Component quantity	2
T3835 Component description	Sausage 1 Beef sausage
T3815 Context identification (linked from component)	DP006 (Food, tobacco and animal food)
T0280 GPC category code (linked from component)	10005833 (beef sausage)
T0082 Net content (linked from component)	200 grams
Class Component (Repeated per unique Component)	(Sausage 2)
T3834 Component number	2
T3836 Component identification	222
T3837 Component quantity	2
T3835 Component description	Sausage 2 Pork sausage
T3815 Context identification (linked from component)	DP006 (Food, tobacco and animal food)
T0280 GPC category code (linked from component)	10005840 (pork sausage)
T0082 Net content (linked from component)	200 grams
Class Component (Repeated per unique Component)	(Sausage 3)
T3834 Component number	3
T3836 Component identification	333
T3837 Component quantity	2
T3835 Component description	Sausage 3 Lamb sausage

T3815 Context identification (linked from component)	DP006 (Food, tobacco and animal food)
T0280 GPC category code (linked from component)	10005835 (lamb sausage)
T0082 Net content (linked from component)	200 grams

Other information stated on the trade item level, e.g. T0082 Net content: 600 grams, T0018 Functional name: "SAUSAGE MIX THREE FLAVORS x 2," etc.

T4088 Ingredient statement and T3850 Compulsory additive label information

Below are examples of texts that should be adjacent to the ingredient statement.

If an ingredient is followed by an asterisk (*), the reference text shall always be entered in T4088.

Examples of texts specified in T4088 Ingredient statement

Text	Specified in
Innehåller lakrits – personer som lider av högt blodtryck bör undvika överdriven konsumtion.	T4088
Innehåller en fenylalaninkälla.	T4088
Rökt med rökarom av lönn och ek.	T4088
Drivgas: xxxxxxxx	T4088
Potatismjöl är tillsatt för bibehållen finfördelning.	T4088
Ingrediensernas procentfördelning kan variera.	T4088
Till 100g färdig produkt har 130g fläskkött använts.	T4088
Kan innehålla spår av ...(allergener)	T4088
*Ekologiskt certifierad ingrediens.	T4088
*Trehalos bryts ner till glukos och fruktos.	T4088
Kakaopulver: Fairtrade-certifierad ingrediens från Fairtrade-producenter. Totalt 98 %.	T4088
KRAV -certifieringen verifierad av Kiwa.	T4088 if asterisk exists, in T3850 if there is no asterisk.
*Uppfött och slaktat i ...	T4088 if asterisk exists. If there is no asterisk, text should be entered in T4202.

Examples of texts specified in T3850 Compulsory additive label information

Text	Specified in
Innehåller ingefära – rekommenderas inte för gravida kvinnor.	T3850
Kraftigt saltad	T3850
Skinnet är inte ätbart. Avlägsnas före förtäring.	T3850
Ostens kant skall inte ätas.	T3850
Oliverna är maskinellt urkärnade. Någon kärna eller rest av kärna kan därför finnas kvar.	T3850
Hög koffeinhalt. Rekommenderas ej för barn och gravida eller ammande kvinnor (32mg Koffein/ 100mg).	T3850
Innehåller: X % fruktjuice från koncentrat och X % tillsatt socker.	T3850
Med tillsats av växtsteroler eller med tillsats av växtstanoler.	T3850

Uppgift om att artikeln inte är avsedd för personer som inte behöver kontrollera kolesterolhalten i blodet.	T3850
Uppgift om att patienter som tar kolesterolsänkande läkemedel endast bör inta varan i samråd med läkare.	T3850
Väl synlig uppgift om att livsmedlet från näringssynpunkt kan vara mindre lämpligt för gravida och ammande kvinnor samt barn under fem år.	T3850
Råd om att livsmedlet ska användas som en del av en balanserad och varierad kost som innefattar regelbundet intag av frukt och grönsaker för att upprätthålla karotennivåerna.	T3850
Uppgift om att intag av mer än 3 g per dag av tillsatta växtsteroler/växtstanoler bör undvikas.	T3850
En definition av en portion av livsmedlet eller livsmedelsingrediensen i fråga (helst i g eller ml) med uppgift om hur mycket växtsteroler/växtstanoler en portion innehåller.	T3850

Other examples of texts specified in T3850

Text	Specified in
Från x år.	T3850
Får ej sväljas.	T3850
Inte lämplig för barn under 3 år.	T3850
För barn upp till 6 år. Använd en klick tandkräm som är lika stor som en ärtä.	T3850
Får inte användas av barn under x år.	T3850
Varning! Innehåller leksaker. Övervakning av vuxna rekommenderas.	T3850
Får ej användas utspädd.	T3850
Använd ej i eller nära ögonen.	T3850
Kan orsaka allergiska reaktioner, särskilt på känslig hud. Avstå från användning om du får en allergisk reaktion.	T3850
Innehåller xx g frukt per 100 g slutgiltig produkt.	T3850
Varning: Förvaras oåtkomligt för barn.	T3850
Plastpåsar är inte leksaker, dra ej påsen över huvudet.	T3850
Barn kan sätta jordnötter i halsen.	T3850
Varning – Innehåller smådelar. Inte lämplig för barn under 36 månader.	T3850
Under transport kan innehållet sjunka ihop.	T3850
Bröstmjök är bäst för barnet och rekommenderas de första 6 månaderna.	T3850
Produkterna bör förvaras utom räckhåll för små barn.	T3850
Kosttillskott bör inte användas som ett alternativ till en varierad kost och hälsosam livsstil.	T3850
En varning för att överskrida den angivna rekommenderade dagliga dosen.	T3850

Examples of texts specified in other attributes

Text	Specified in
Äkta alspånsrökt	T3746
SVENSKT MJÖL 100% mjöl från svenskodlat spannmål malt i egen kvarn	T3746
Rekommenderad daglig dos	T4070

Information for system developers and recipients of Trade Item Information

In addition to this guideline, system developers and recipients of Trade Item Information need the following documents in order to get all necessary information:

- **The Business Document Specification (BDS).** The BDS and the Guideline must be read together.
- **The Correction documents** are valid from the time at which they are published and should be read together with the specifications.
- **GDSN Validation** comprise the global validation rules used to validate Trade Item Information in Validoo.
- **Swedish Validation rules** comprise additional local validation rules that apply for the Swedish market.

Technical documentation for Trade Item Information is found here: <https://gs1.se/en/guides/documentation/>

To search in the document press Ctrl+F.

Note that attributes are structured differently in this guideline compared to the BDS. The structure of the BDS is based on GS1's global data model, where attributes are grouped into modules, while the structure of this guideline is based on a logical grouping of attributes. The structure of this guideline is shown in the figure below.

Structure of Trade Item Information as described in this guideline

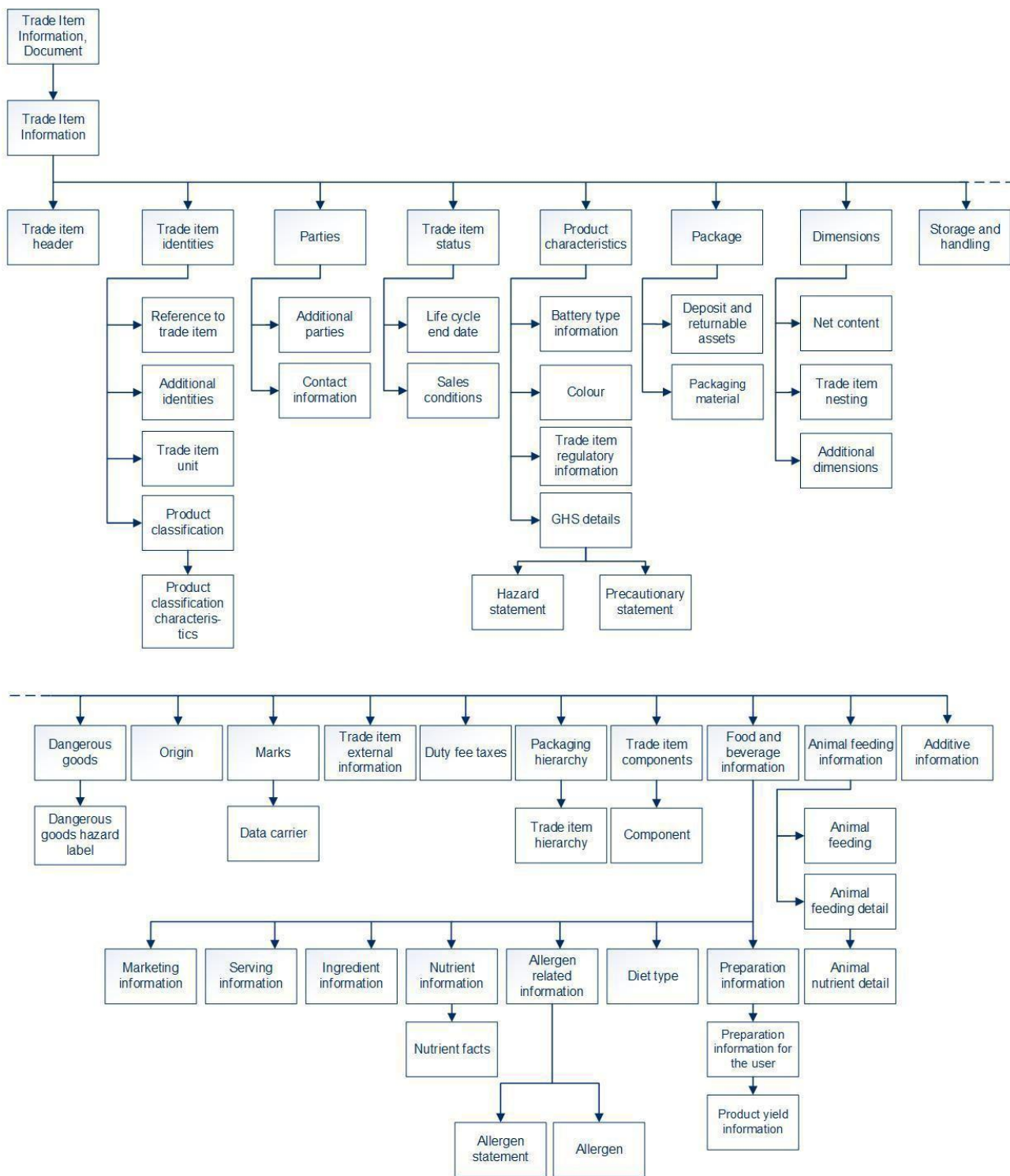

Figure 22 In this guideline, Trade Item Information is described as a series of logical groups in a hierarchical structure.